



MINISTRY OF AVIATION

AERONAUTICAL RESEARCH COUNCIL

CURRENT PAPERS

Tests with a Variable Ramp Intake Having  
Combined External/Internal Compression,  
and a Design Mach Number of 2.2

By

*M.C. Neale and P.S. Lamb*

LONDON: HER MAJESTY'S STATIONERY OFFICE

1965

PRICE 6s. 6d. NET



U.D.C. No. 533.697.2:533.6.011.5:621.438-225

C.P. No. 805

Tests with a variable ramp intake having combined external/internal compression, and a design Mach number of 2.2

- by -

M. C. Neale and P. S. Lamb

August, 1962

SUMMARY

Results are reported of tests on a two-dimensional combined external/internal compression intake having a design Mach number of 2.2. The effects of changes in the form of the ramp bleed slot and the subsonic diffuser were examined. In addition tests were made with a crude form of sidewall bleed.

The maximum pressure recovery obtained at the design Mach number was 87 per cent with a bleed of 2.8 per cent of the capture flow.

CONTENTS

	<u>Page</u>
1.0 Introduction	4
2.0 Description of the model	4
3.0 Test procedure	6
4.0 Results and discussion	7
5.0 The prospects for improvements in performance	9
6.0 Conclusions	9

Detachable Abstract Cards

ILLUSTRATIONS

<u>Fig. No.</u>	<u>Title</u>
1	Basic arrangement of the model
2	The model mounted in Cell 1
3	Photographs of the model
4	Variation of subsonic diffuser geometry with movement of the bleed slot
5	The two supersonic geometries tested showing the original ram scoop bleed
6	The two subsonic diffusers tested
7	Modified ramp bleed I Bleed slot with curved entry
8	Modified ramp bleed II Step bleed
9	Sidewall bleed
10	Pressure recoveries measured with the builds featuring ram scoop bleeds
11(a)	Schlieren photograph of throat flow pattern with ram scoop bleed (intake supercritical)
11(b)	Cowl Mach number distribution - intake supercritical - ram scoop bleed

ILLUSTRATIONS (cont'd)

<u>Fig. No.</u>	<u>Title</u>
12	Pressure recoveries measured with modified bleeds
13	Schlieren photograph of throat flow pattern with step bleed (intake critical)
14	Sidewall secondary flow pattern
15	Cowl Mach number distribution - intake supercritical - step bleed
16	Effect of subsonic diffuser changes
17	Effect of sidewall bleed on pressure recovery
18	Proposed ramp bleed slot

## 1.0 Introduction

The present paper describes a model variable ramp intake having a design Mach number of 2.2, and summarizes the main results that were obtained when the model was tested in Cell 1 of the Engine Test Facility at N.G.T.E. Although both the intake and its design Mach number are currently very much in fashion on account of their application to proposed supersonic transport aircraft, the tests were primarily intended to provide general aerodynamic information, and except in one or two respects were not related specifically to any particular project. Preliminary measurements of pressure fluctuations during "buzz", although taken, are not presented here; the associated electronic measuring techniques are still under development and a further paper on the subject will be issued in due course.

## 2.0 Description of the model

### (a) General

The construction of the model was derived to a large extent from the internal compression intake tested earlier in Cell 1. The supersonic diffuser projected forward from a conical housing which acted as the inner spill shield when the model was mounted in the Cell, and which contained the subsonic diffuser and much of the control gear. Figure 1 shows the arrangement of the model, and Figure 2 the method of mounting in the cell. Photographs of the model are shown in Figure 3.

The model was designed so that both the shock pattern and the subsonic diffuser could be changed by the substitution of different components. "Starting", in the sense of establishing supersonic flow, could be achieved either by retracting the cowl backwards along the line AB in Figure 1, or alternatively by lowering both the ramp and one wall of the subsonic diffuser as indicated by the broken lines in the Figure.

The subsonic diffuser wall and the ramp could be positioned independently of each other, the ramp by pivoting about the point X in Figure 1, and the wall of the subsonic diffuser by pivoting about position Y. Thus it was possible to obtain different openings to the throat bleed at the termination of the ramp surface for fixed positions of either the diffuser or the ramp. The diffuser pivot was sufficiently far aft for adjustments of the position of the knife edge at the bleed slot to produce only very small changes in the subsonic diffuser geometry. The variation for the long subsonic diffuser is plotted in Figure 4. Increasing all the angles by about  $1^{\circ}$  gives the variation for the short subsonic diffuser. A butterfly valve for controlling the position of the normal shock in the main intake flow was provided downstream of the exit from the subsonic diffuser. The bleed was not throttled. It discharged into a plenum, whence it was removed through two ducts acting as measuring lengths and containing pitot tubes and static tappings

The model controls were electrically powered, and the positions of the different components recorded remotely by "Desynn" indicators. A pneumatic drive was designed to enable the whole model to be rotated through either  $90^{\circ}$  or  $180^{\circ}$ . Thus the nozzle incidence facility built into the cell allows testing at both positive and negative pitch and at yaw.

The intake capture height and span were respectively  $2\frac{1}{2}$  and  $3\frac{1}{2}$  in. The capture plane aspect ratio was thus 1.4, a value roughly equal to that suggested for projected supersonic transport aircraft.

The tests were made with an inlet total pressure of approximately 40 in.Hg abs, which, with temperatures of about 20°C - sufficiently low to avoid mechanical expansion difficulties on the model - gave a free stream Reynolds number based on the intake capture height of approximately  $1 \times 10^6$ . Ultimately it is intended to test the model at full scale Reynolds numbers corresponding with an intake capture height of approximately 3 ft, and flight at  $M = 2.2$  at an altitude of 60,000 ft. The model was therefore designed to withstand loadings corresponding with the inlet total pressure of approximately 5 atmospheres that will be required in simulating full scale conditions. One consequence was that in order to provide sufficiently stiff side walls, and also sidewall windows both large enough to permit satisfactory observation of the throat flow and of sufficient strength, the sidewall chamfer was more blunt than is desirable in an actual installation. At zero incidence the chamfer was  $16^\circ$  in the tunnel flow direction and  $27\frac{1}{2}^\circ$  degrees perpendicular to the swept edge, which meant that the shock generated by the sidewalls was detached from their leading edges. Estimates based on previous work however indicate that the effect on capture mass flow is small and unlikely to seriously affect the performance of the model. Nevertheless it is intended to check the effect of chamfer angle in further tests on the present model.

Instrumentation was as follows:-

9 static tappings along the length of the cowl commencing in the plane of the throat and covering the entry section of the subsonic diffuser.

3 static tappings distributed along the length of the subsonic diffuser sidewall.

20 total head tubes distributed on an equal area basis and forming a rake in the exit plane of each subsonic diffuser.

2 static tappings on the subsonic diffuser sidewall in the plane of the rake.

In addition to the bleed duct instrumentation already mentioned:-

1 static tapping in the entrance to the ramp bleed.

1 static tapping in the bleed plenum.

A pressure transducer was fitted in the sidewall of the subsonic diffuser at the diffuser exit plane.

The throat flow was observed by Schlieren apparatus.

(b) Model geometries tested

The two supersonic geometries that were tested were designed to give "shock on lip" operation, as in Figure 5, with oblique shock strengths of  $7^\circ$ ,  $7^\circ$ ,  $10^\circ$  and  $9^\circ$ ,  $5^\circ$  and  $10^\circ$  respectively, but without allowance for boundary layer growth. For a free stream Mach number of

2.2 these shock patterns give a terminal supersonic Mach number of 1.38, and a total shock loss, including that through the normal shock, of 6.1 per cent. A lower Mach number immediately upstream of the normal shock would be expected to give higher pressure recoveries. However, the previous experience of the authors suggested that for the initial testing of the present model a terminal supersonic Mach number of as high as 1.38 would help to avoid running into difficulties with the supersonic diffusion.

The two subsonic diffusers that were tested are shown in Figure 6. The profiling was confined to one surface in order to simplify the construction of the model. The area changes are equal in both diffusers. Relative to the capture height the length of the shorter of the two diffusers corresponds very closely with the length, for the same proportional area change, of diffusers proposed for transport installations. However the shorter diffuser tested here continues diverging to an overall area ratio of slightly more than 2/1, whereas a typical full scale proposal stops short at an overall area ratio of approximately 1.75/1. A further difference is that the diffusers shown in Figure 6 are two-dimensional throughout, whilst full scale proposals tend to include a transition from rectangular to circular cross section within the length of the diffuser.

Initially the model was tested with a ram scoop bleed in the ramp surface at the throat, as shown in Figure 5. Subsequent modifications to the ramp bleed are shown in Figures 7 and 8. No provision was made in the first stage of the design for sidewall bleed, but towards the end of the experimental programme some tests were made with the relatively crude form of sidewall bleed shown in Figure 9.

### 3.0 Test procedure

Prior to running the tunnel the "Desynms" indicating the positions of the ramp and subsonic diffuser (and hence the bleed opening) were calibrated for positions of the diffuser tip, measured from the line of the cowl, and ramp positions measured by inserting slip gauges in the bleed openings, as shown in Figure 7.

The most convenient starting procedure was to position the throttle wide open and translate the cowl rearwards. The cowl was then returned to its design position, whilst the ramp and subsonic diffuser were so positioned that with a 0.1 in. bleed slot the internal oblique shock from the cowl fell on the tip of the subsonic diffuser. Readings were taken for different throttle settings covering a range of positions for the normal shock from fully supercritical, through "buzz", to fully expelled forwards.

The procedure was repeated for bleed openings of 0.05 in. and 0.15 in., which were obtained by pivoting the diffuser wall carrying the bleed slot knife edge. As would be expected, these subsequent adjustments moved the point of impingement of the internal oblique shock very slightly away from the lip of the bleed slot. With the 0.05 in. opening the shock was very slightly downstream of the lip, whilst it was a little upstream with the 0.15 in. opening. However the movement was very small. It was only just discernable with the 3/1 optical magnification of the Schlieren apparatus, and tests showed that its effect was negligible on both pressure recovery and bleed.



Some tests were carried out over a limited range of incidence and will be reported later. The present paper reports only those tests that were made at zero incidence.

#### 4.0 Results and discussion

##### (a) Tests with the long subsonic diffuser shown in Figure 5

The most marked features of the first results were the rather disappointing pressure recoveries, and the very strong shock wave emanating from the region of the ram scoop bleed slot. Figure 10 shows that the pressure recoveries measured with the two shock patterns tested were within 1 per cent of each other, and virtually invariant with changes in bleed flow. The mean level of recovery, at  $83\frac{1}{2}$  per cent, is low compared with the recovery of 93.9 per cent based on the losses of the theoretical shock pattern alone. Figure 11(a) shows the throat flow pattern, which was fairly typical of both shock configurations and all bleed openings. The disturbance at the bleed slot knife edge is most noticeable, and the consequent effect on the Mach number distribution along the cowl is shown in Figure 11(b). The drop in Mach number following the impingement of the shock from the diffuser lip is followed by a region of expansion in which the Mach number rises locally to 1.54. The reasons for the indicated Mach number in the farthest forward position indicated on Figure 11(b) being as high as 1.46 are not clear, as with the supersonic geometry unaltered, save for the substitution of a step bleed to be discussed later, the design throat Mach number of 1.38 was achieved.

The disturbance at the ram scoop bleed slot appeared to worsen as the height of the ram scoop was increased, and this effect is suggested as a possible explanation of the pressure recovery remaining virtually constant as the bleed was increased. Disadvantages of ram scoop bleed would seem to be the blockage caused by the projecting scoop in a region very sensitive to area change, and also the likelihood of the accompanying flow deflections exceeding the local detachment angle.

Subsequent modifications to the bleed slots were shown in Figures 7 and 8. The build originally designed for theoretical oblique shock strengths of  $9^\circ$ ,  $5^\circ$  and  $10^\circ$  was given a 3 in. radius, commencing 1 in. upstream of the throat, and blending into the bleed as in Figure 7. The build having the  $7^\circ$ ,  $7^\circ$  and  $10^\circ$  theoretical oblique shock pattern was fitted with the step bleed shown in Figure 8. Figure 12 shows the effect on pressure recovery of the bleed modifications. Most noticeable is that whereas with the original ram scoop bleed there was nothing to choose between the two builds tested, after modification the build with the step bleed clearly gave the better performance. The highest pressure recovery was 87 per cent with 2.8 per cent bleed at a free stream Mach number of 2.2. The form of the curves suggests that higher recoveries might have been obtained with higher bleed flows, and this possibility will be investigated during the next test series.

Although the flow still became more unsteady at the largest bleed opening (a result which is ascribed to the bleed slot becoming more of a ram scoop, and less of a flush slot), the modifications to the bleed produced a much more stable flow. With the modified bleeds it was possible to locate the normal shock within 0.25 subsonic diffuser entry heights downstream of the bleed slot knife edge, as shown in Figure 13. In the earlier builds stable location of the normal shock could only be

achieved farther downstream in the subsonic diffuser. Part of the improvement can be explained in terms of the behaviour of the sidewall secondary flow developing along the line of the internal oblique shock as shown in Figure 14. This stream of low energy air was shown by liquid tracer techniques to be split into two by the unmodified ram scoop bleed. Part of the stream entered the bleed slot, but the remainder passed into the subsonic diffuser, where inevitably it would tend to prevent the formation of a clean normal shock. However, with both forms of modified bleed, but particularly the step, all the liquid traces indicative of secondary flow were deflected into the bleed passage. In addition to the valuable role of the internal oblique shock in deflecting the secondary flow towards the bleed slot, the expansion around the corner of the step bleed also appeared to be useful in drawing the low energy air into the bleed. Supercritical plots of the Mach number distribution along the cowl for two openings of the step bleed (two diffuser positions and a fixed ramp position) are shown in Figure 15. Compared with the plot for the unmodified bleed the most noticeable feature is the marked reduction of the influences of both the shock from the diffuser lip and the subsequent expansion. It will also be noted as commented earlier, that the cowl Mach numbers at the point nearest the cowl lip correspond closely with the design figure of 1.38.

The design shock configurations (in the sense that the internal oblique shock impinged on the subsonic diffuser lip, and the throat static pressure corresponded with a Mach number of 1.38) were obtained with ramp angles slightly below the design values, the difference presumably forming a measure of the boundary layer growth. Thus with the step bleed the design shock pattern of  $7^\circ$ ,  $7^\circ$ ,  $10^\circ$  was obtained with angles, based on the model geometry of  $7^\circ$ ,  $5^\circ$  and  $8^\circ$ . With the curved entry into the bleed slot, angles of  $9^\circ$ ,  $4^\circ$  and  $9^\circ$ , based on model geometry, were used to obtain the design shock pattern of  $9^\circ$ ,  $5^\circ$  and  $10^\circ$ . The total boundary layer growth on the supersonic diffuser surfaces therefore appeared to be equivalent to a total flow deflection of between  $2^\circ$  and  $4^\circ$ .

An interesting consequence of the reduced ramp angle necessary to provide the design shock pattern (in the sense defined previously), was that the reduced internal contraction made it possible to "restart" the intake after shock expulsion by use of the throttle alone. A more detailed investigation of this phenomenon will be made in a later test programme. It was noted that the internal contraction between the cowl lip and the throat required to produce the design shock pattern corresponded almost exactly with the maximum theoretically possible for self starting on the assumption of one-dimensional flow.

(b) Subsonic diffuser changes

In the builds featuring the ram scoop bleed, substitution of the shorter of the two subsonic diffusers shown in Figure 6 reduced the pressure recovery by between 2 and 3 per cent. After the modifications to the bleed, which it will be recalled enabled the normal shock to be positioned much closer to the throat than previously, the pressure recoveries given by both subsonic diffusers became almost identical. Figure 16 shows the experimental points. The results are consistent with earlier work with an all internal compression intake operating at a free stream Mach number of 3, where it was shown that provided a clean normal shock near the diffuser entrance is obtained, increased rates of subsonic diffusion become possible.

(c) Sidewall bleed

Towards the end of the test programme perspex sidewall windows, drilled as shown in Figure 9, were fitted to the rig in order to obtain a preliminary estimate of the effect on pressure recovery of sidewall bleed. The bleed discharged directly to the free stream and was not measured. The pressure recoveries shown in Figure 17 are therefore plotted on a base of ramp bleed openings for a given supersonic geometry. An improvement of roughly  $1\frac{1}{2}$  per cent on pressure recovery is noted over the range of geometries that were tested with the longest subsonic diffuser. A test with the shorter subsonic diffuser showed an improvement in pressure recovery of 1 per cent. Simple estimates based on the throttle position suggest that as much as 8 per cent of the intake capture flow was removed through the sidewall holes. A better exchange rate between sidewall bleed and pressure recovery might be obtained with more sophisticated bleeds; the rows of holes used in the present tests were improvised at short notice. On the other hand the present tests without sidewall bleed suggest that the adverse effect of the sidewall boundary layers has been appreciably reduced by designing the ramp bleed to remove much of the sidewall secondary flow.

5.0 The prospects for improvements in performance

The highest pressure recovery obtained during the tests was 87 per cent with 2.8 per cent bleed from the ramp surface. The following possibilities for improving the pressure recovery seem among the more important:-

- (a) Some optimisation of the ramp bleed design. For example, the step bleed used in the present tests may not have been in the best position.
- (b) Larger ramp bleeds than those reported may give improvements in recovery. Bleed slots shaped as in Figure 18 may prove worthwhile.
- (c) Preliminary results suggest that sidewall bleed promises an improvement of about 1 per cent on pressure recovery, or perhaps slightly more.
- (d) An increase in test Reynolds number to simulate full scale conditions would reduce the viscous losses and may improve the pressure recovery. An increase of 1 or 2 per cent would seem possible.
- (e) A re-design of the shock pattern might result in lower terminal supersonic Mach numbers, and need not involve increases in the cowl drag. The reduction in theoretical shock loss could amount to some two percentage points and might be accompanied by an improvement in the performance of the subsonic diffuser.

6.0 Conclusions

A two-dimensional combined external/internal compression intake has been developed to give a maximum pressure recovery of 87 per cent at a free stream Mach number of 2.2 and with 2.8 per cent bleed at the throat from the ramp surface.

The tests have emphasised the importance of the bleed slot design. They have also confirmed that increased rates of efficient subsonic diffusion become possible when the throat conditions allow a "clean" normal shock to be positioned in the entrance to the subsonic diffuser.

At the present stage of the investigation there appears to be a fair chance of increasing the pressure recovery to 90 per cent.

**BASIC ARRANGEMENT OF THE MODEL**

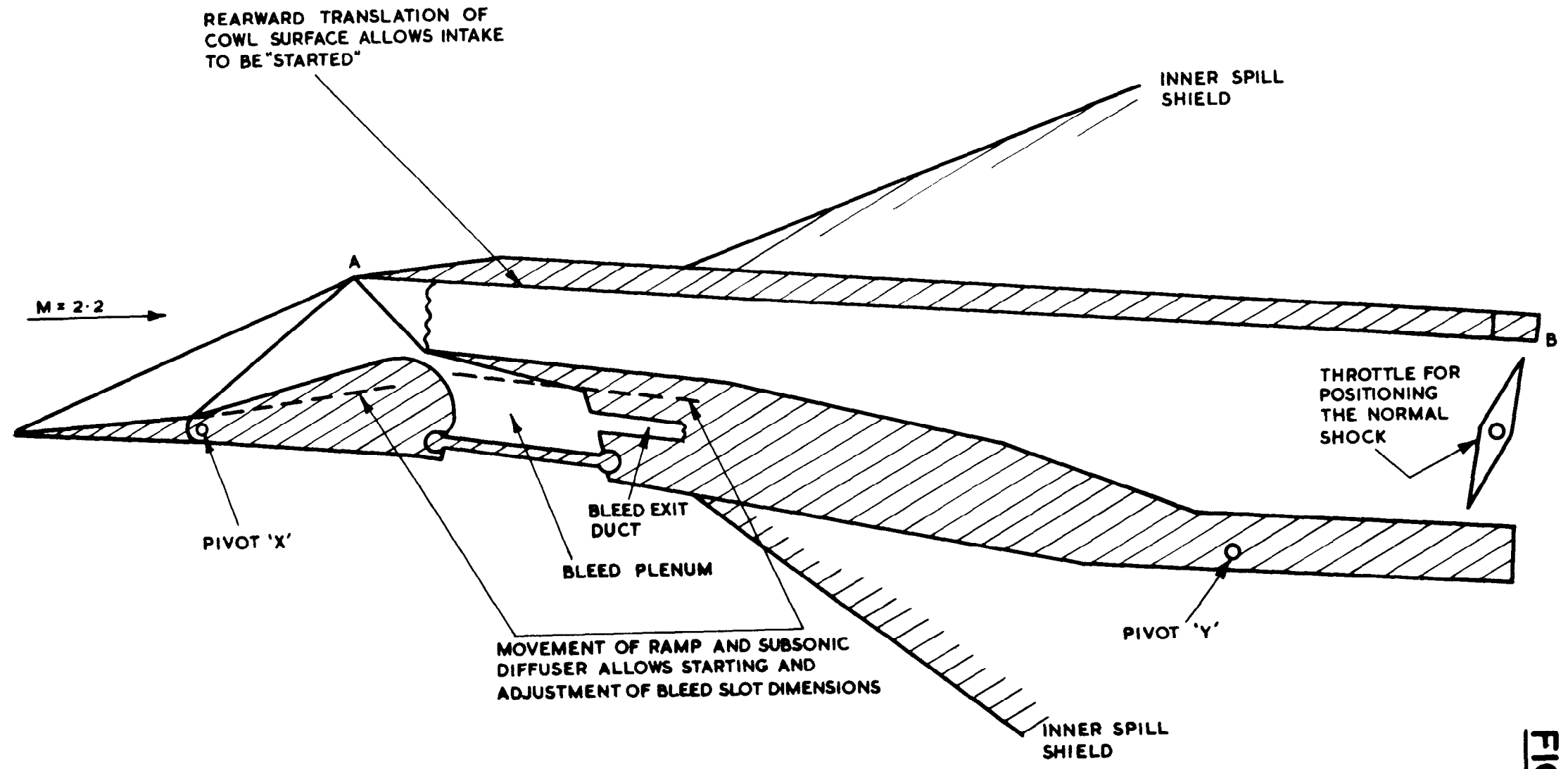

**FIG. 1.**

THE MODEL MOUNTED IN CELL 1

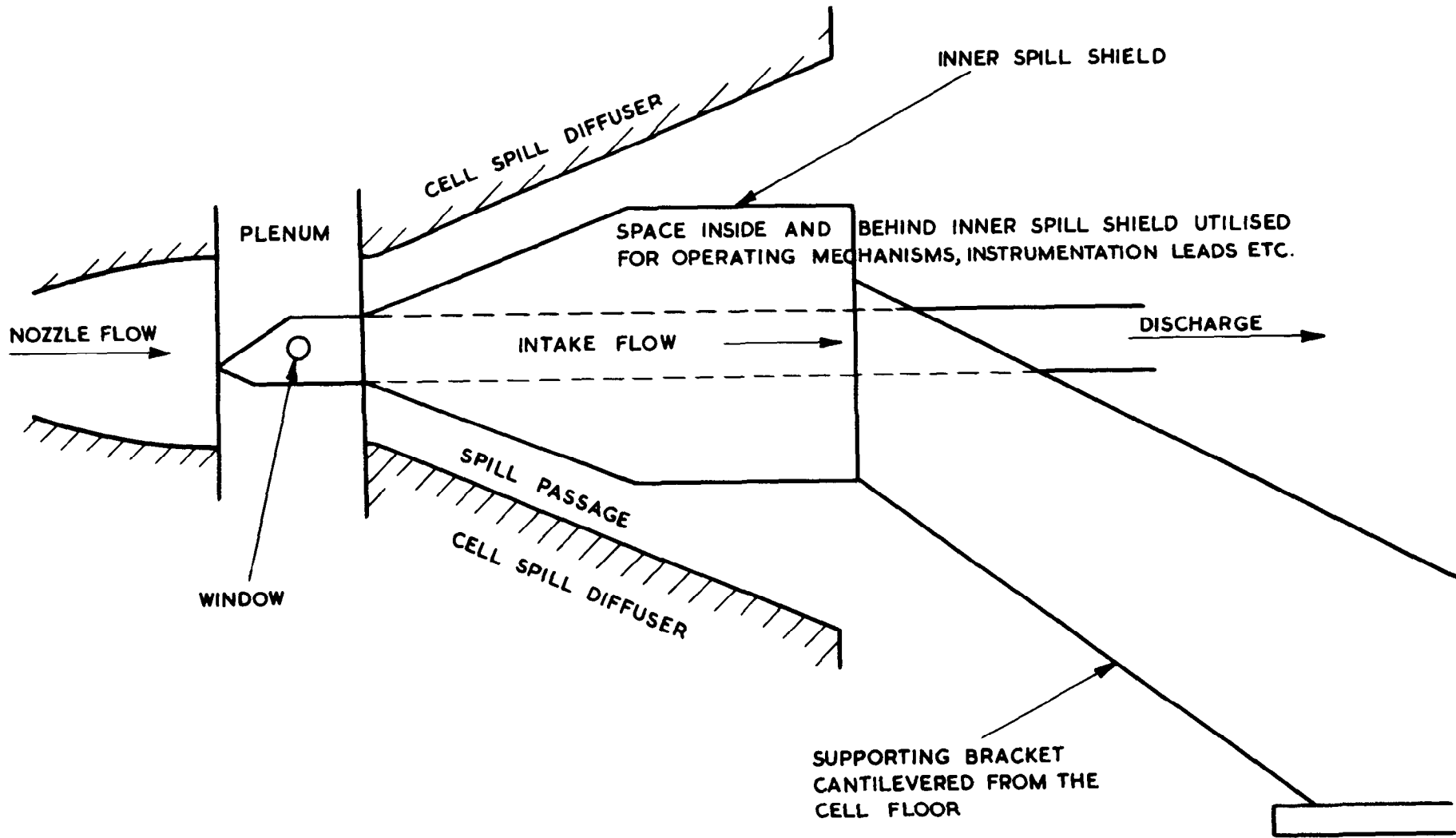
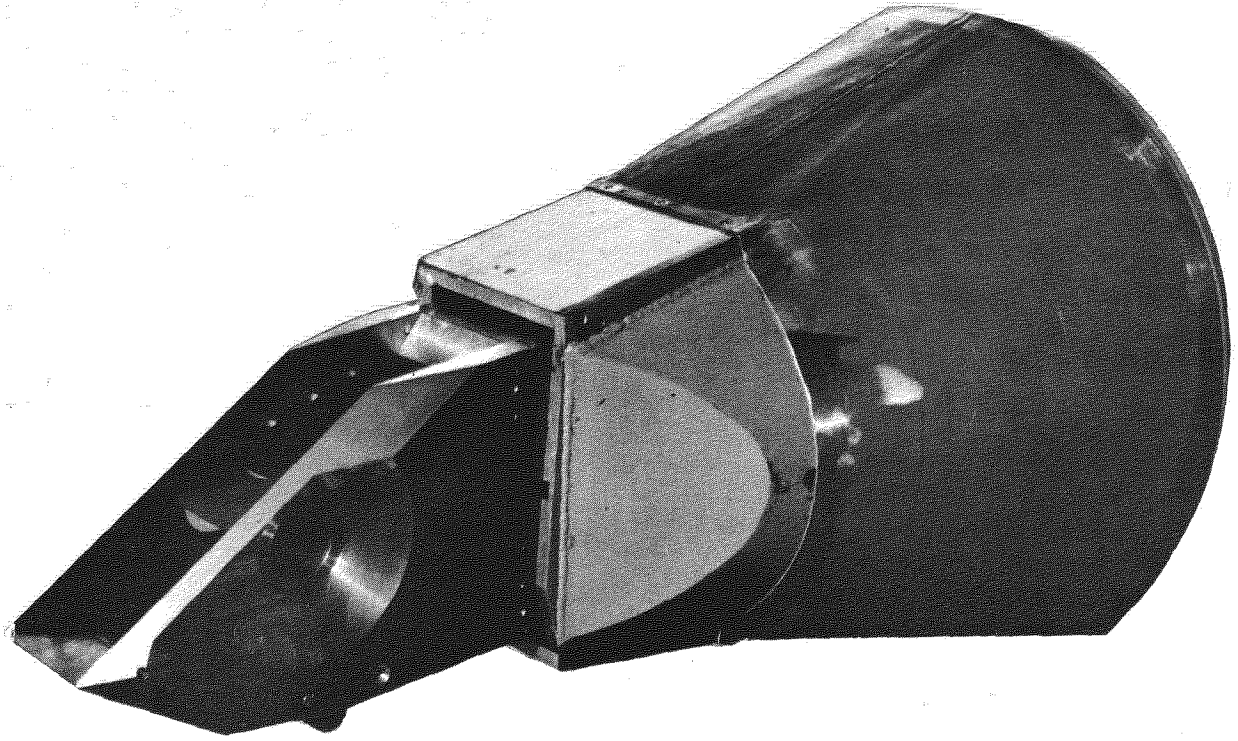
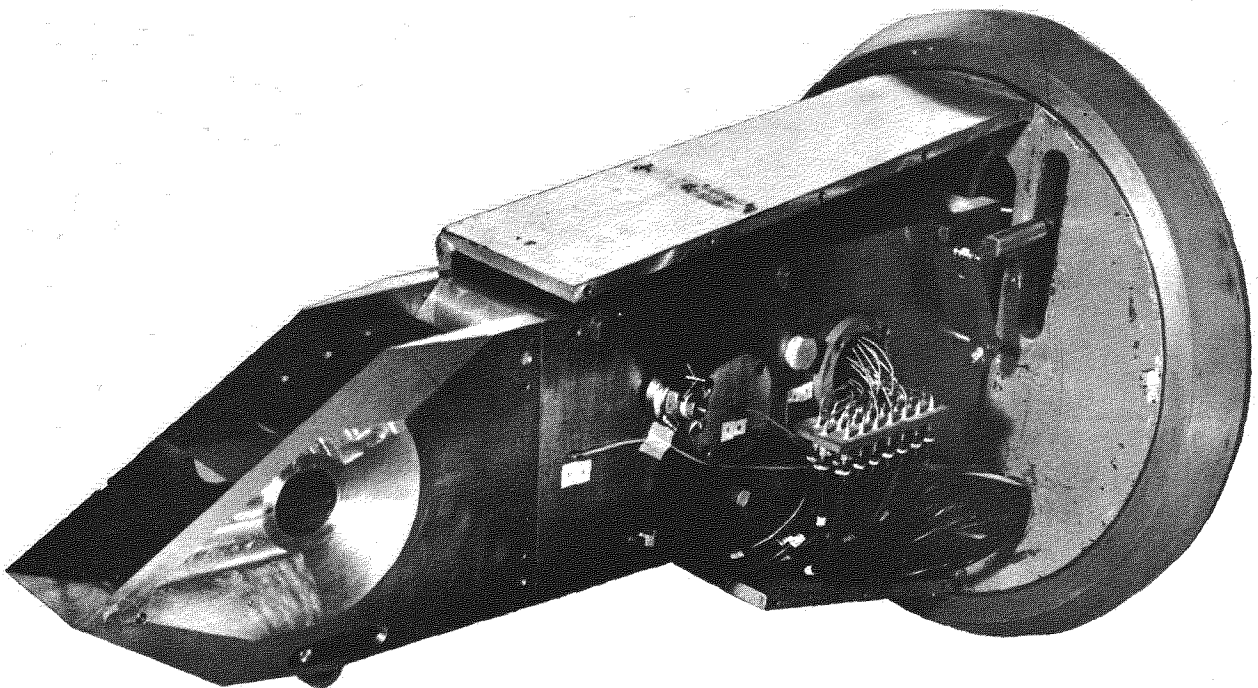

FIG. 2.



(a) THE MODEL ASSEMBLED AND READY FOR TESTING



(b) THE MODEL WITH THE INNER SPILL SHIELD REMOVED

PHOTOGRAPHS OF THE MODEL

**FIG. 4.**

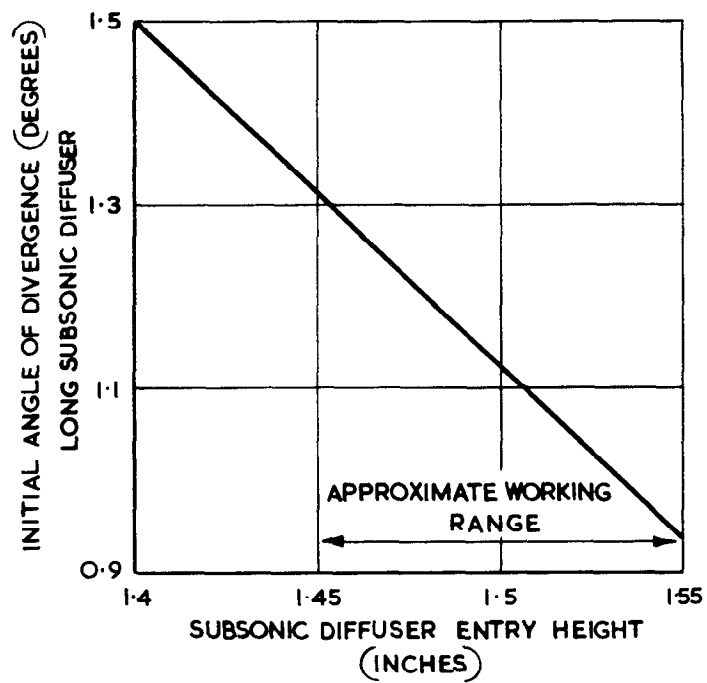

N.B. INCREASING ALL THE ANGLES BY APPROXIMATELY 1 DEGREE  
GIVES THE VARIATION FOR THE SHORT SUBSONIC DIFFUSER

**VARIATION OF SUBSONIC DIFFUSER GEOMETRY  
WITH MOVEMENT OF THE BLEED SLOT**



**FIG. 5.**

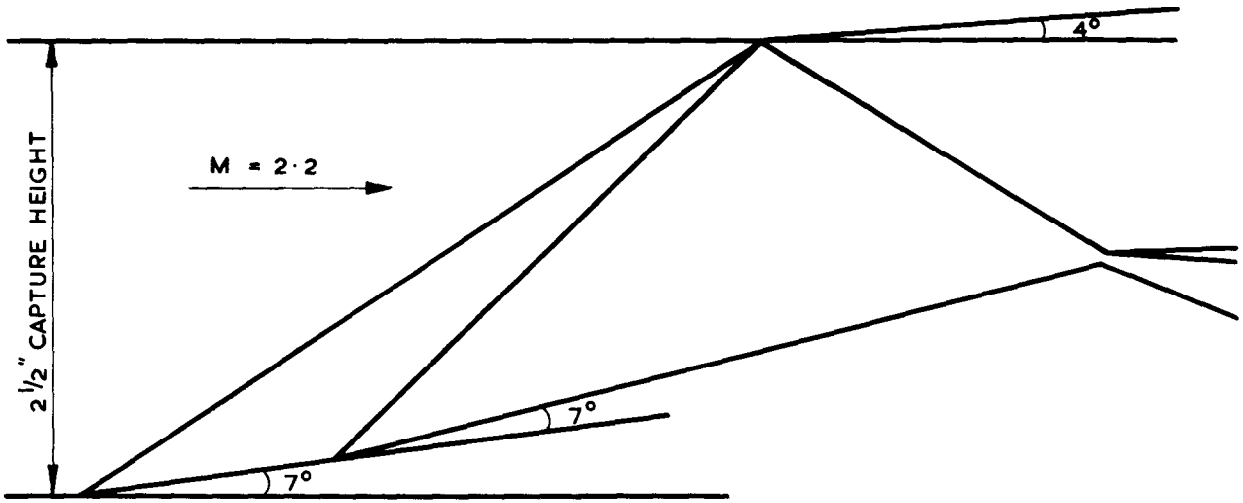

(a) THEORETICAL OBLIQUE SHOCK STRENGTHS  
OF 7°, 7°, AND 10°

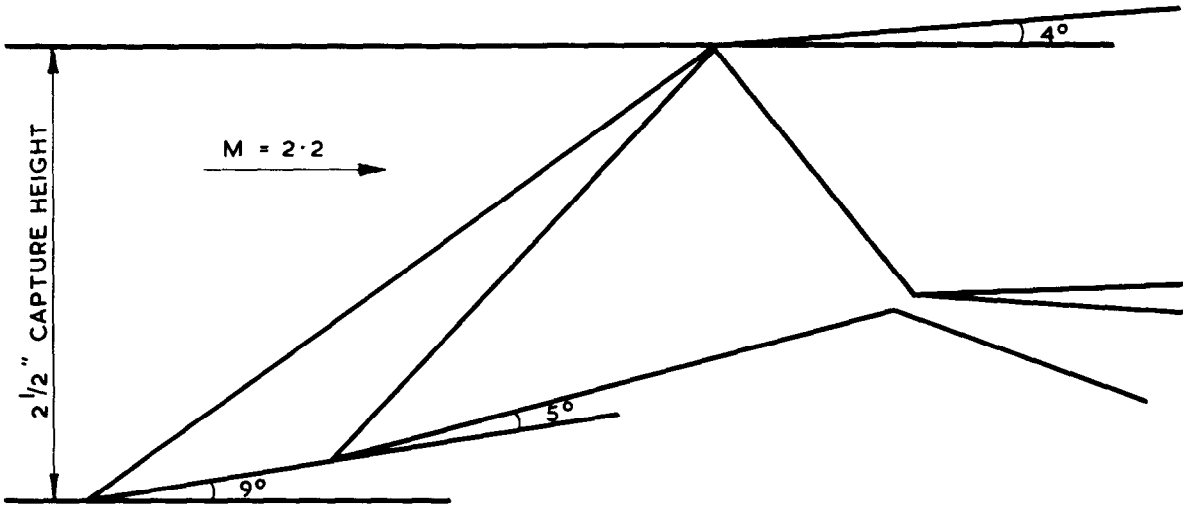

(b) THEORETICAL OBLIQUE SHOCK STRENGTHS  
OF 9°, 7°, AND 10°

SCALE : FULL SIZE

**THE TWO SUPERSONIC GEOMETRIES TESTED**  
**SHOWING THE ORIGINAL RAM SCOOP BLEED**

MACH NUMBER BEHIND  
NORMAL SHOCK  
APPROXIMATELY 0.8

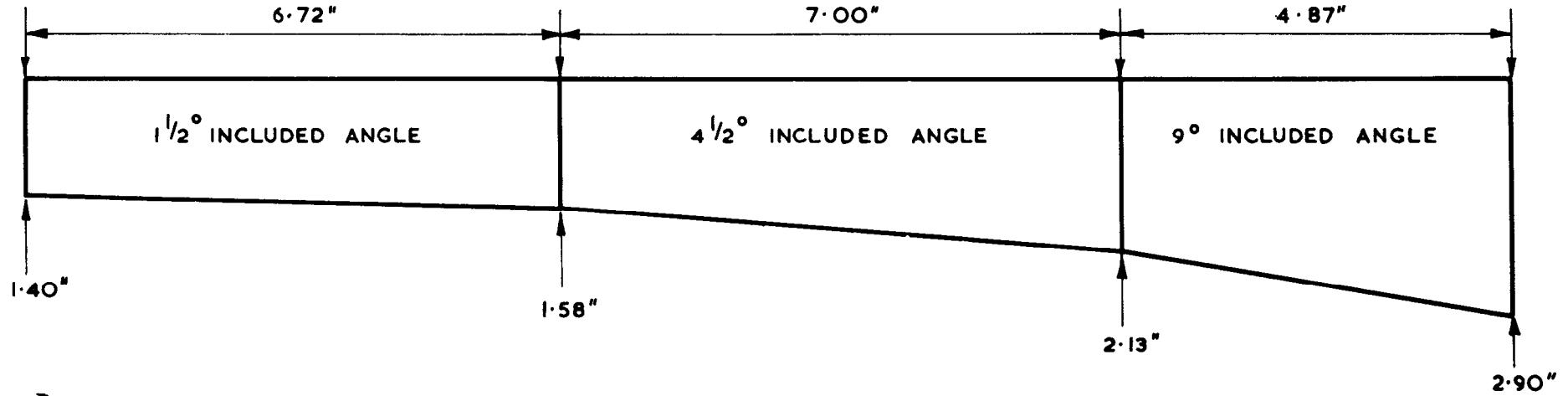

a) LONG DIFFUSER

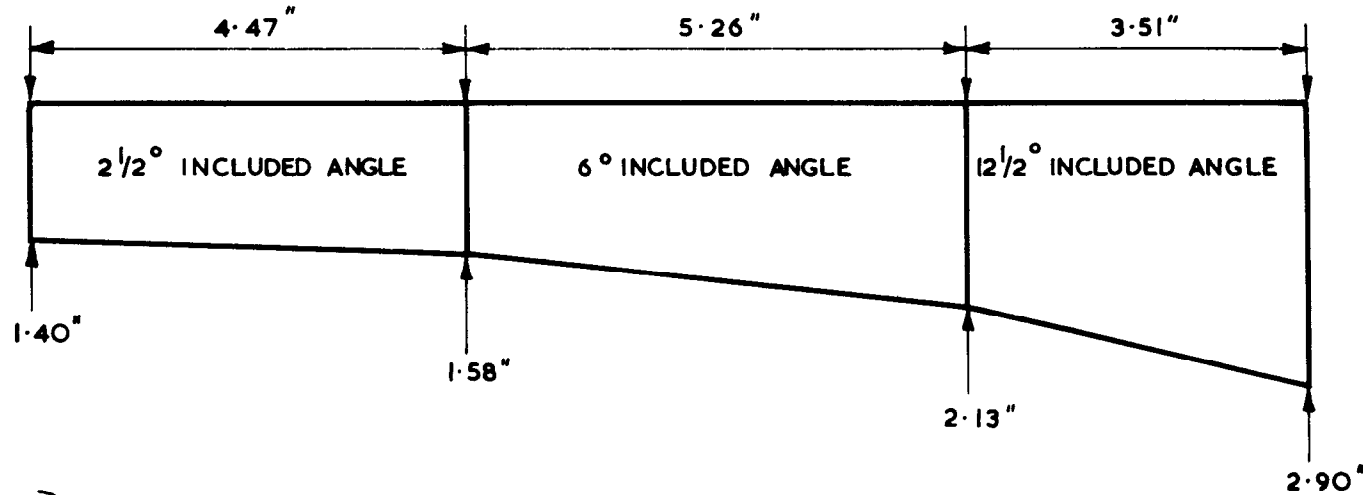

b) SHORT DIFFUSER

SCALE:  $\frac{1}{2}$  X FULL SIZE

FIG. 6.

**FIG. 7.**

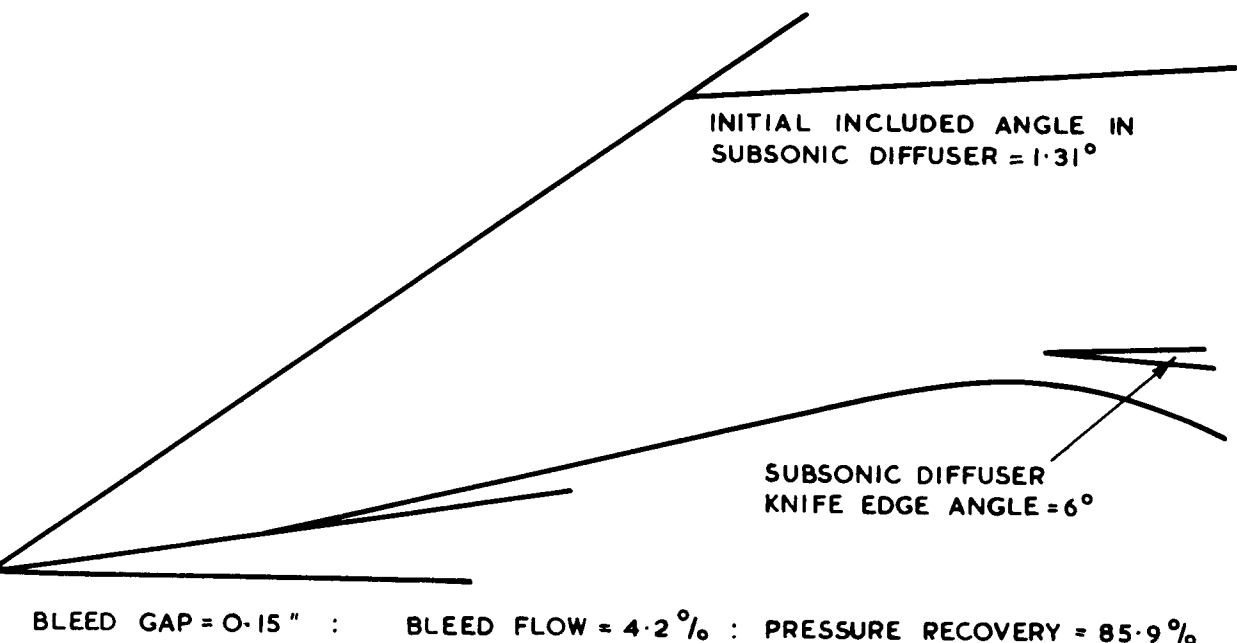
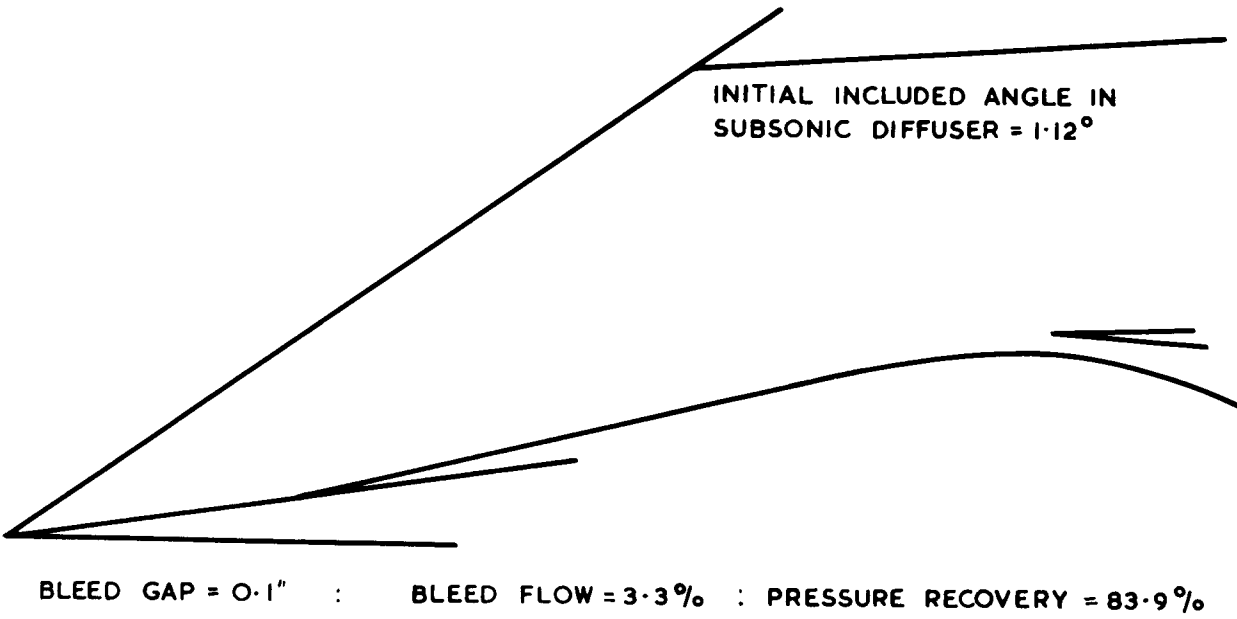
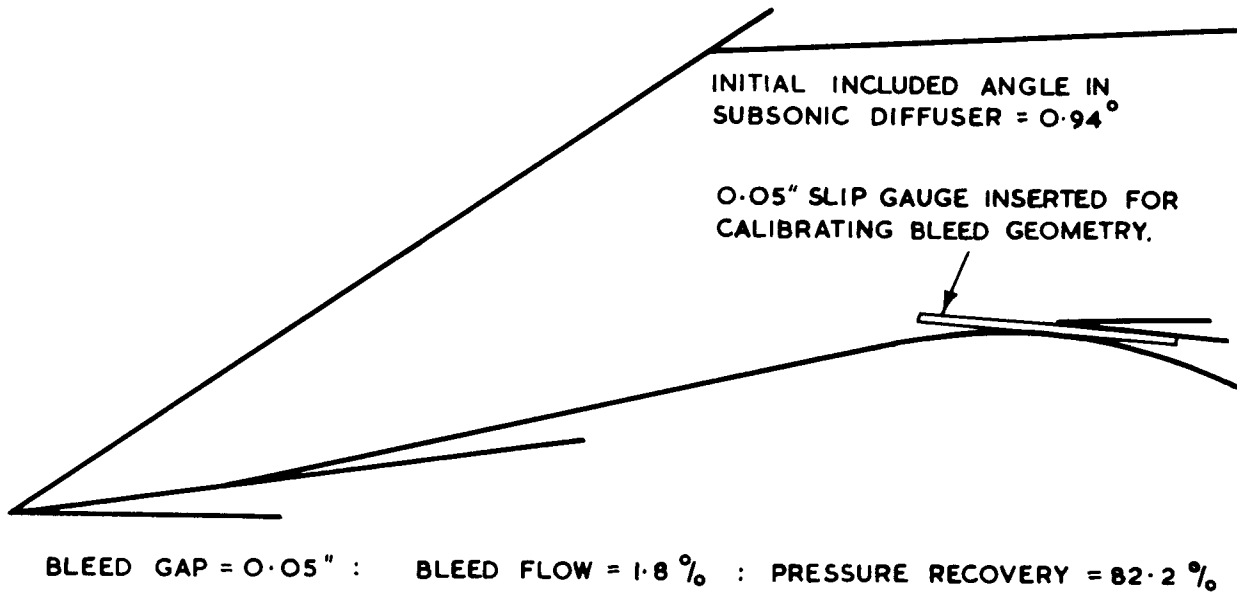

SCALE · FULL SIZE

**MODIFIED RAMP BLEED**  
**I BLEED SLOT WITH CURVED ENTRY**  
**(NO CONTRACTION INSIDE THE BLEED SLOT)**

**FIG. 8.**

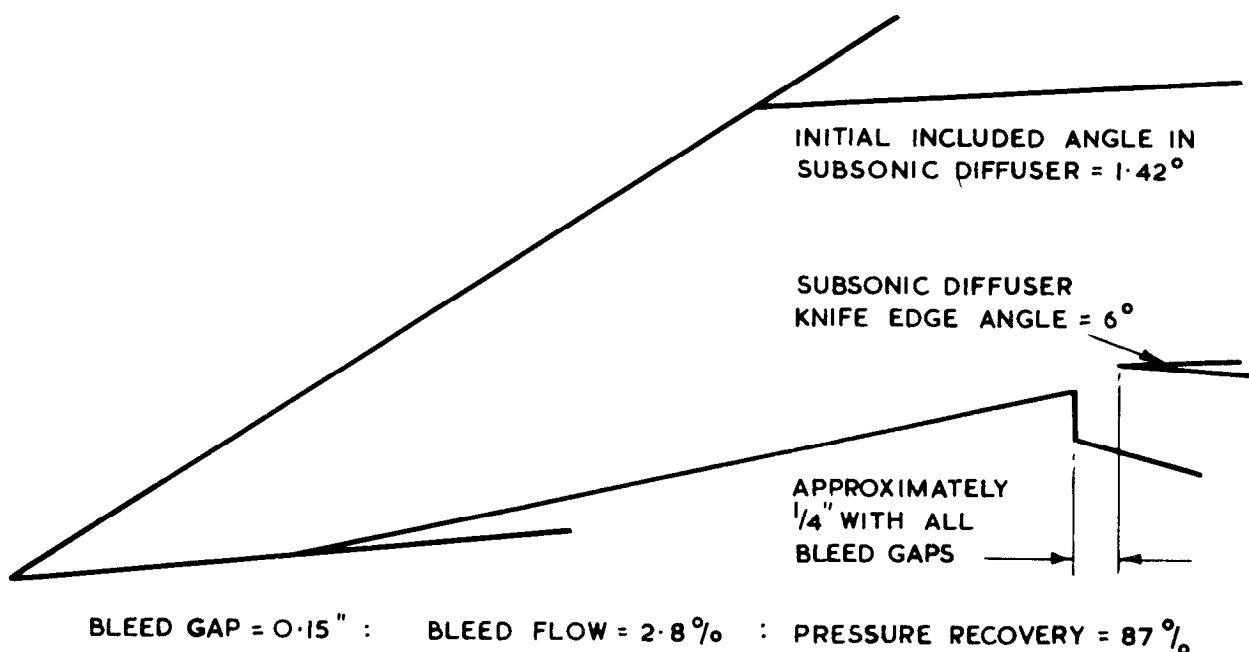
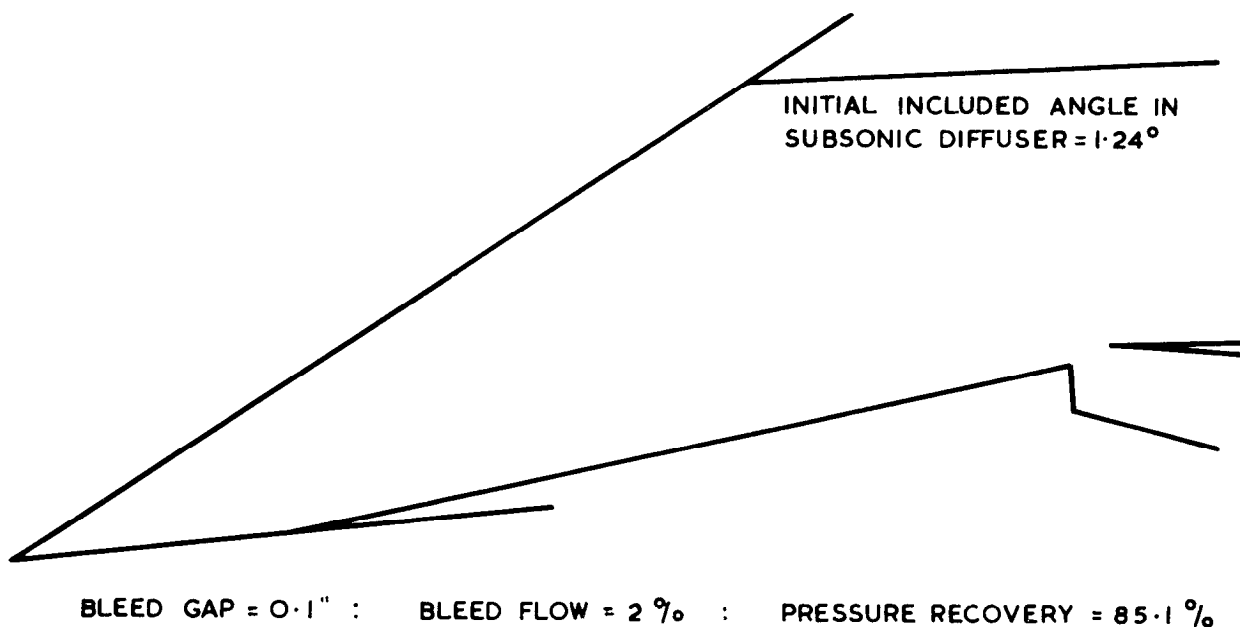
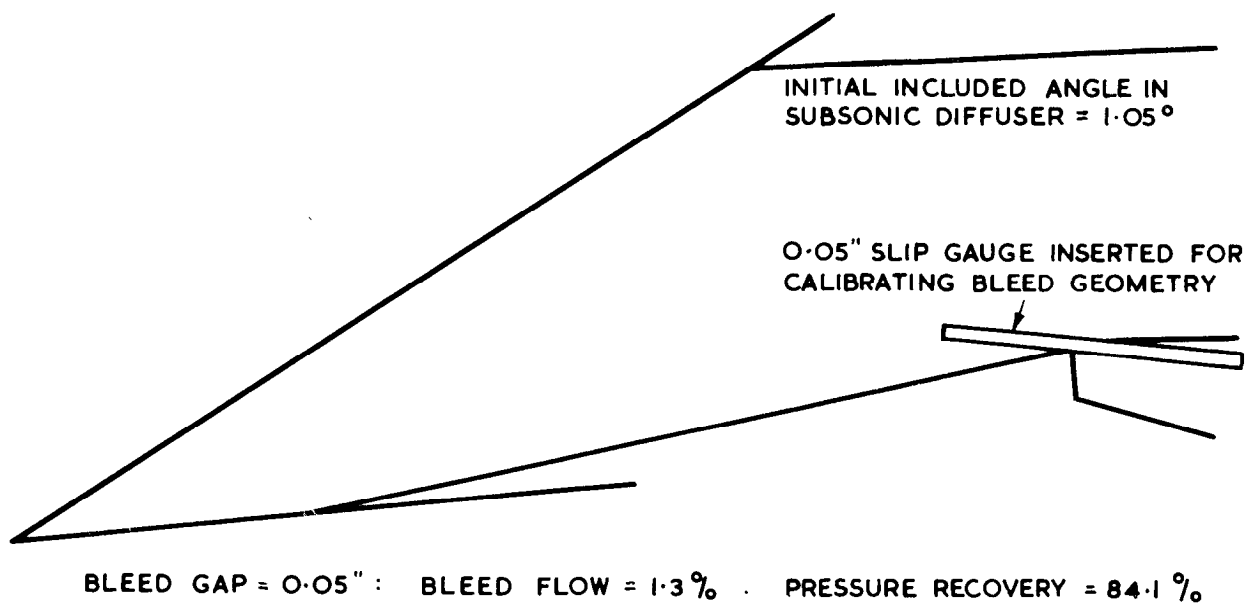

SCALE: FULL SIZE

**MODIFIED RAMP BLEED**

**II STEP BLEED**

**FIG. 9.**

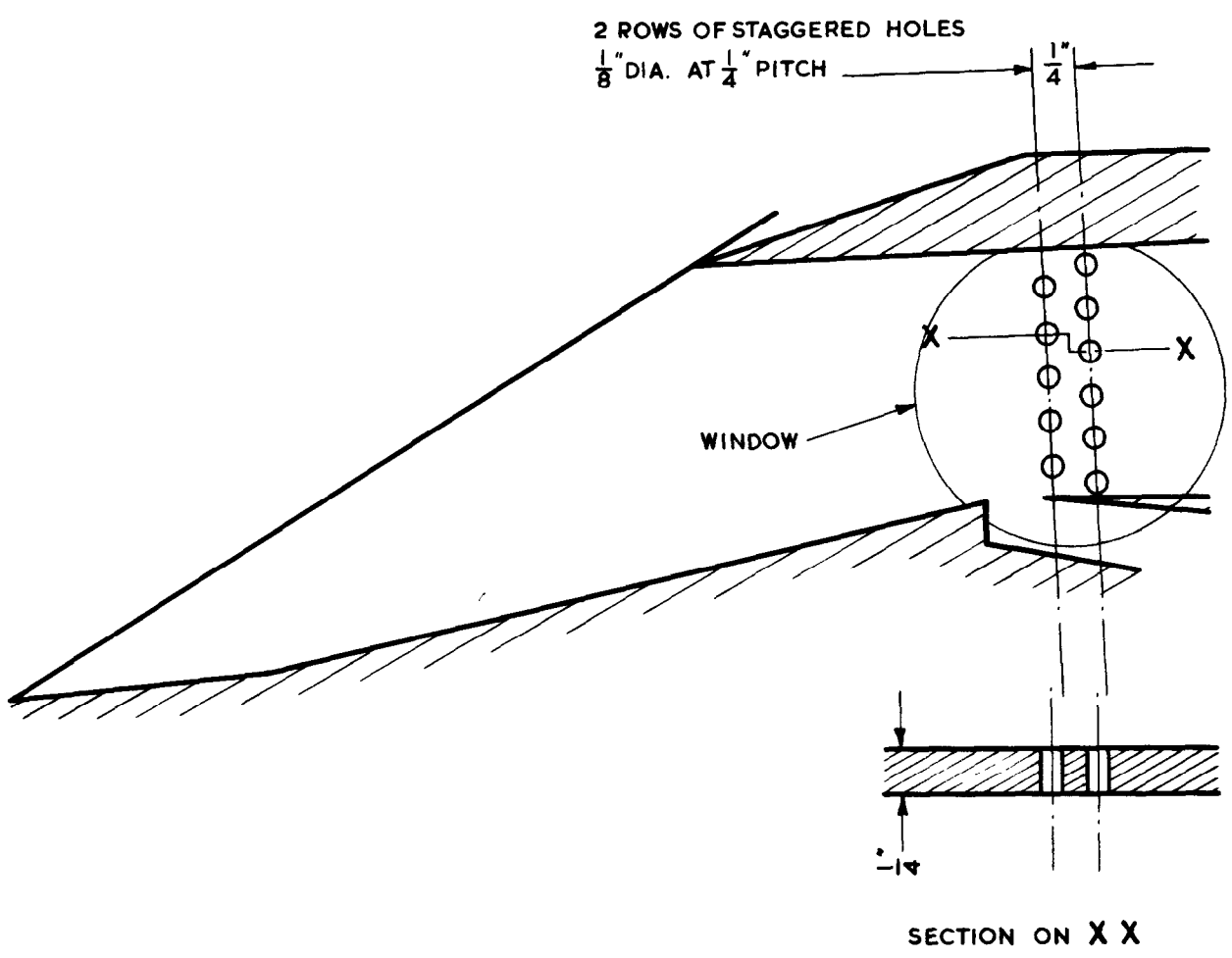

SCALE : FULL SIZE

**SIDEWALL BLEED**

FIG. 10.

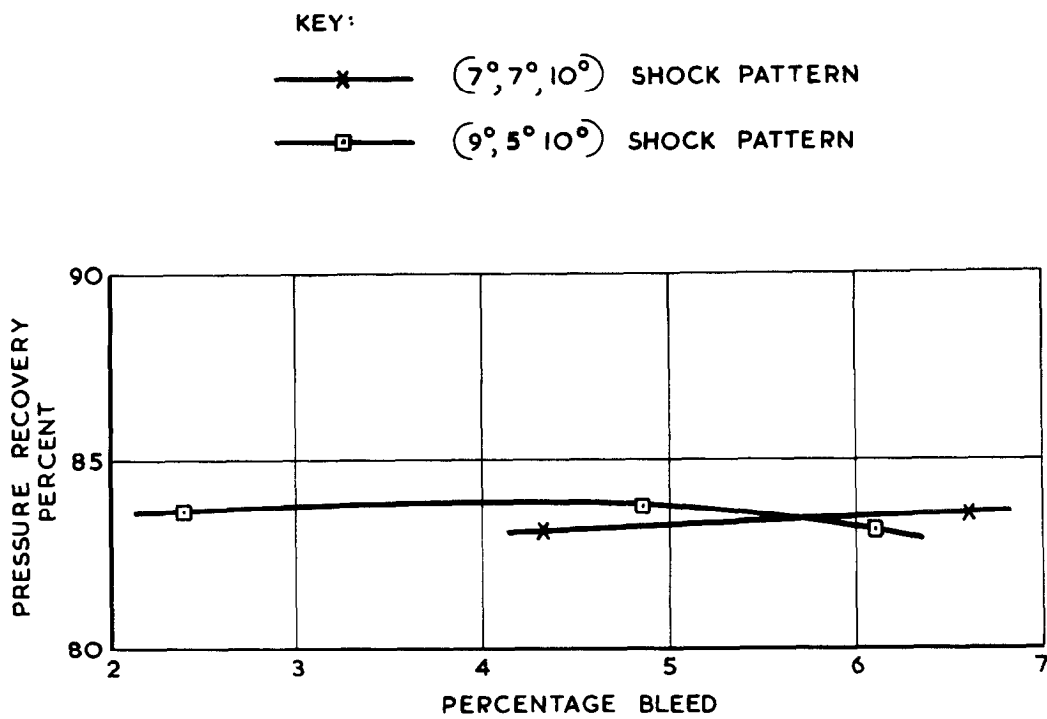

PRESSURE RECOVERIES MEASURED WITH  
THE BUILDS FEATURING RAM SCOOP BLEEDS

**FIG.11**

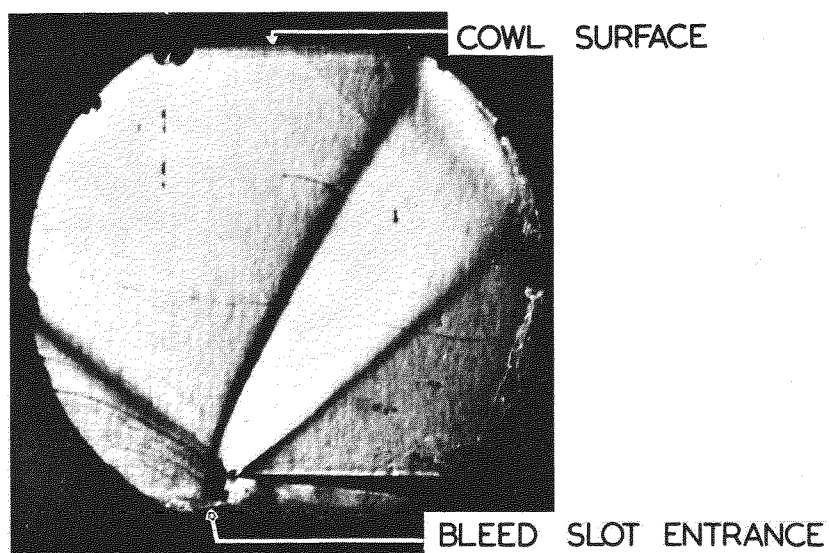

**(a) THROAT FLOW PATTERN WITH RAM SCOOP BLEED - INTAKE SUPERCRITICAL**

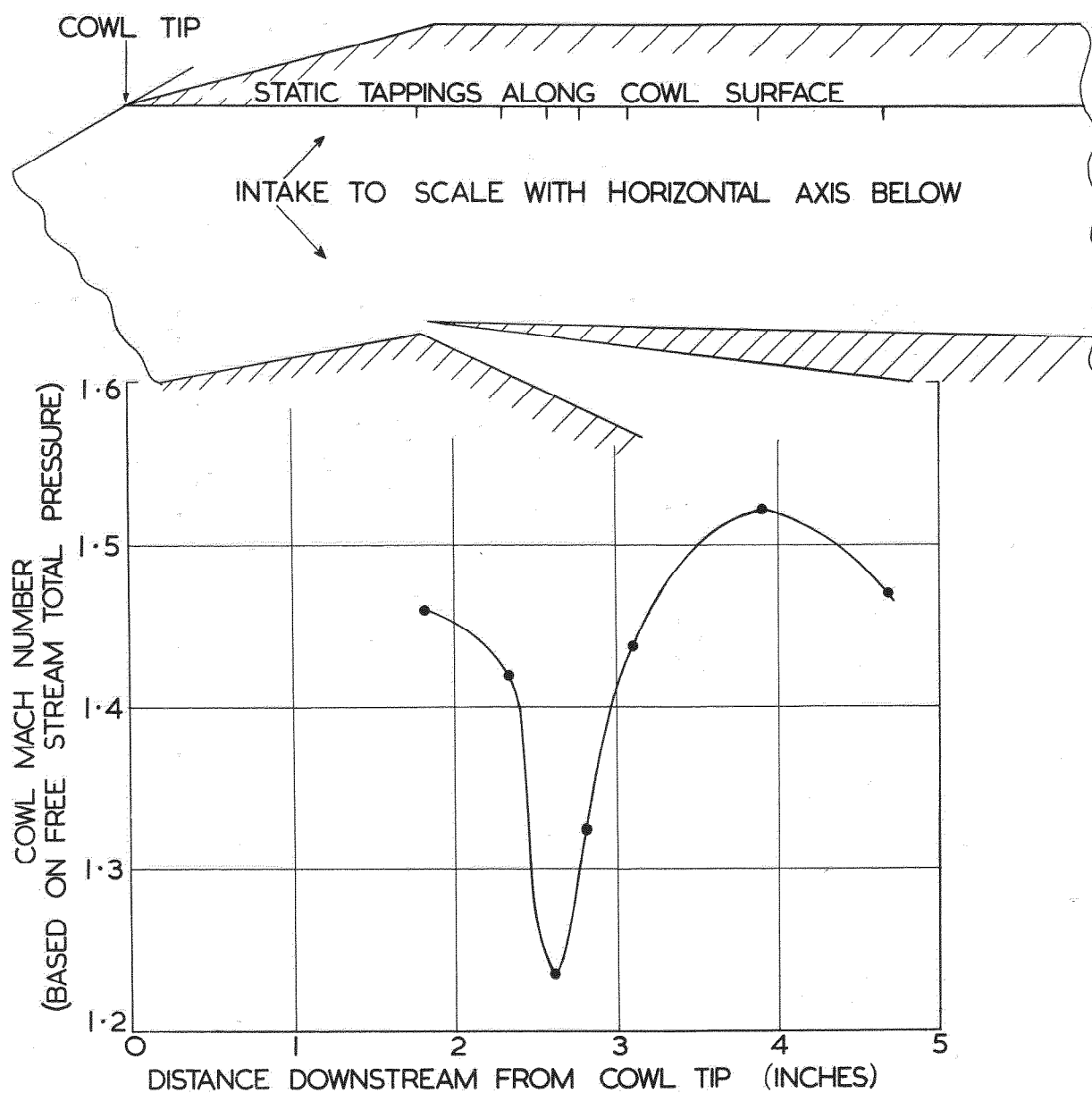

**(b) COWL MACH NUMBER DISTRIBUTION-INTAKE SUPERCRITICAL RAM SCOOP BLEED**

FIG. 12.

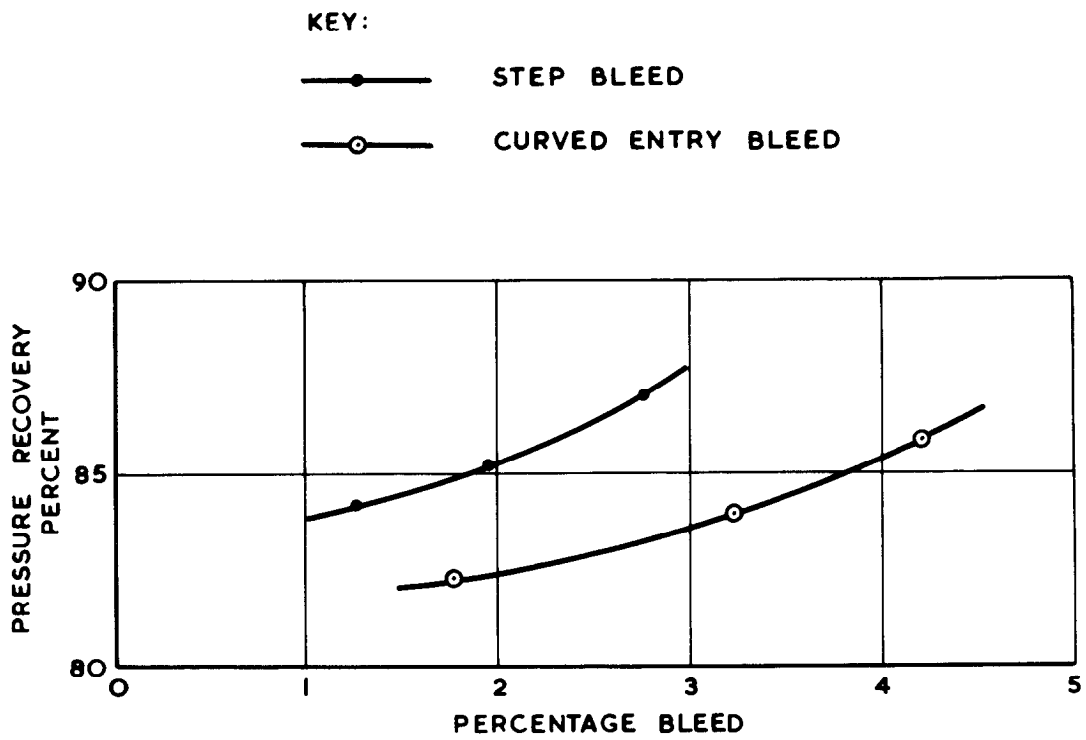

PRESSURE RECOVERIES MEASURED WITH  
MODIFIED BLEEDS



FIG. 13

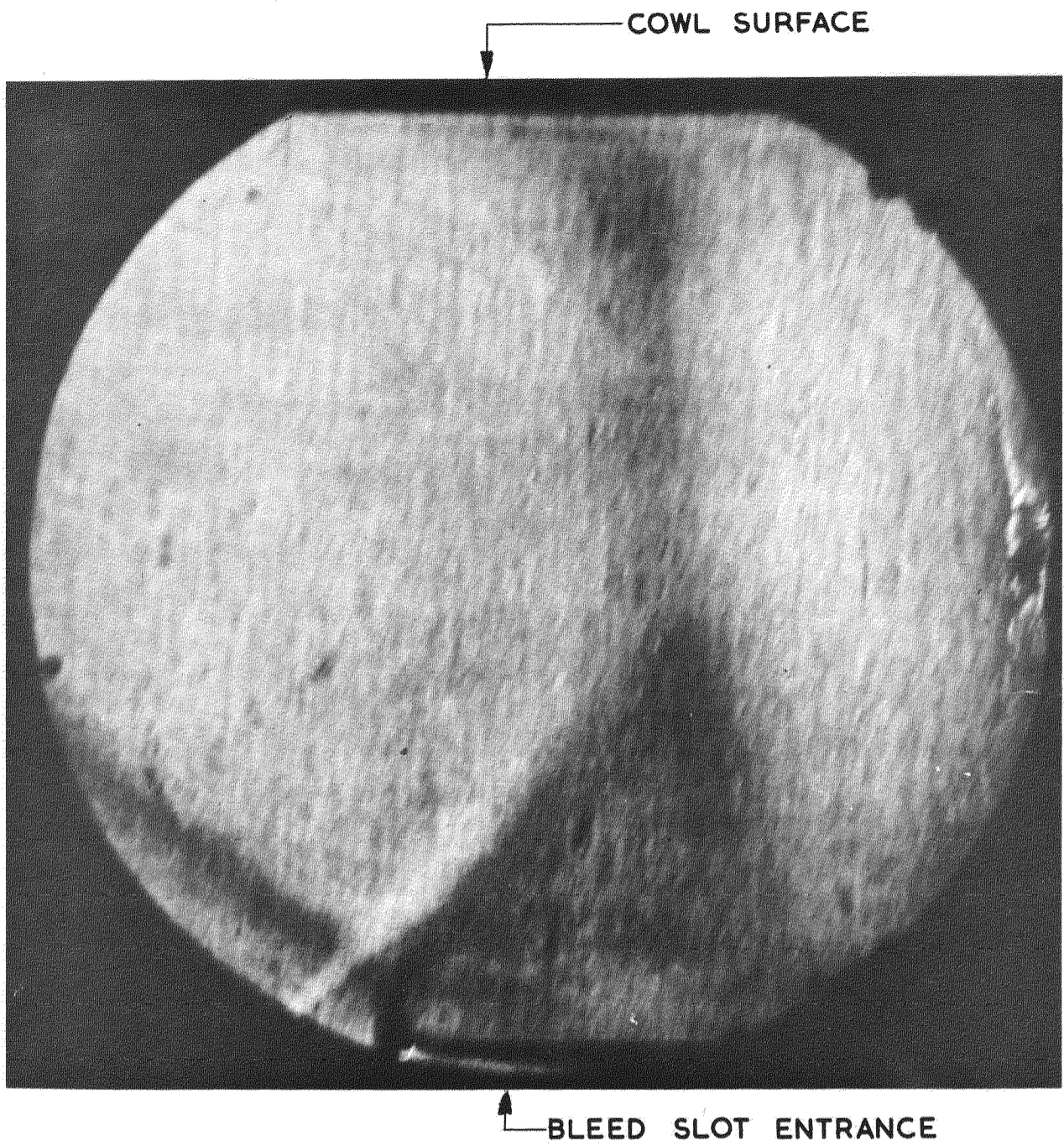

THROAT FLOW PATTERN  
WITH STEP BLEED  
(INTAKE CRITICAL)

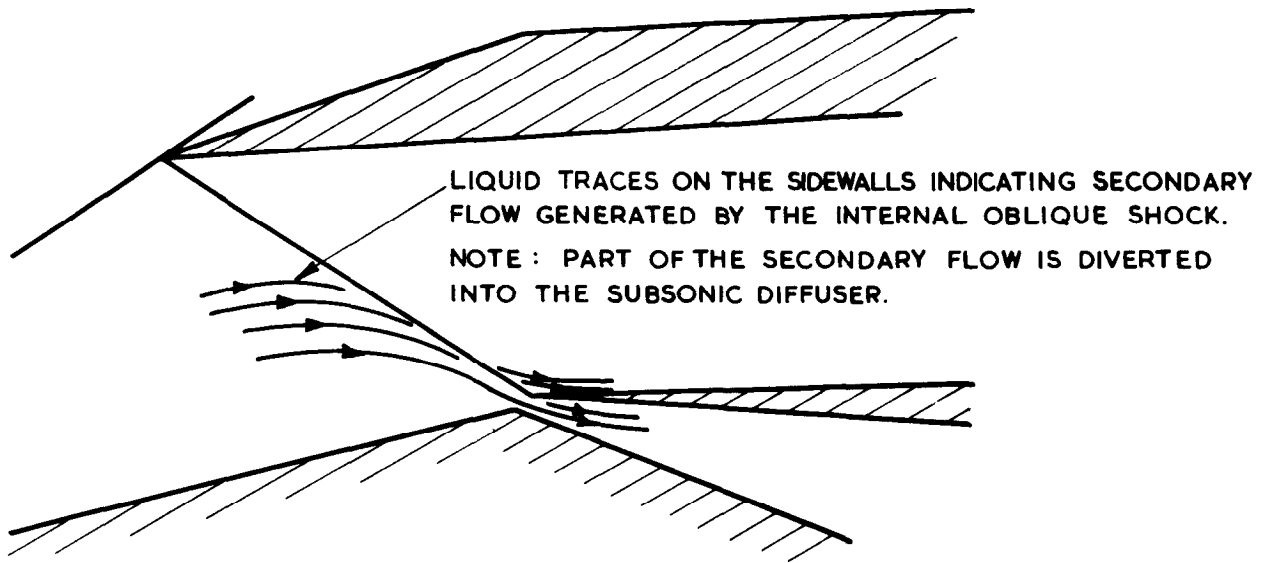

(a) RAM SCOOP BLEED

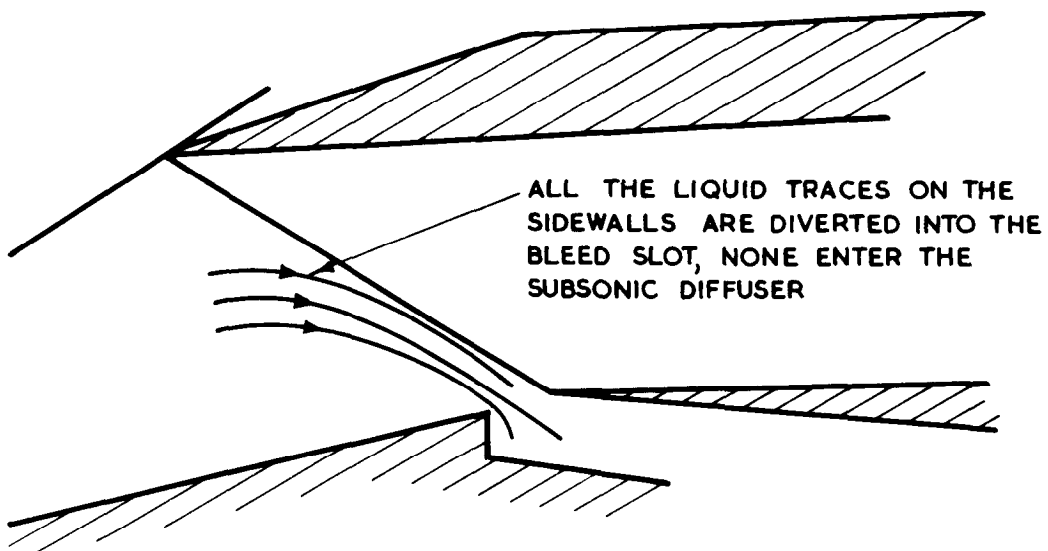

(b) STEP BLEED

**SIDEWALL SECONDARY FLOW PATTERN**

**FIG.15.**

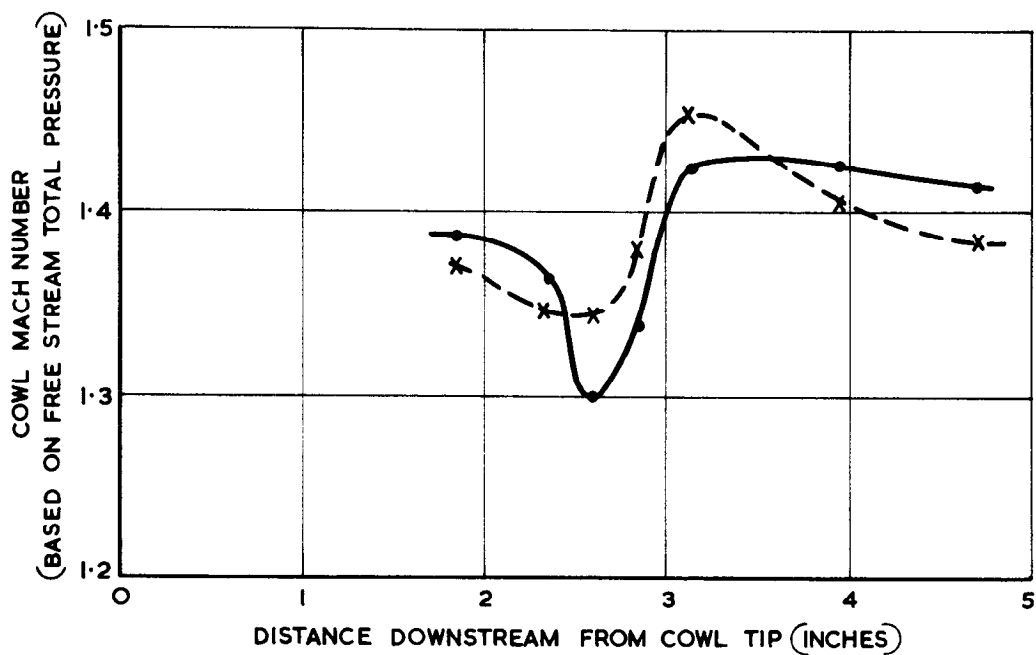
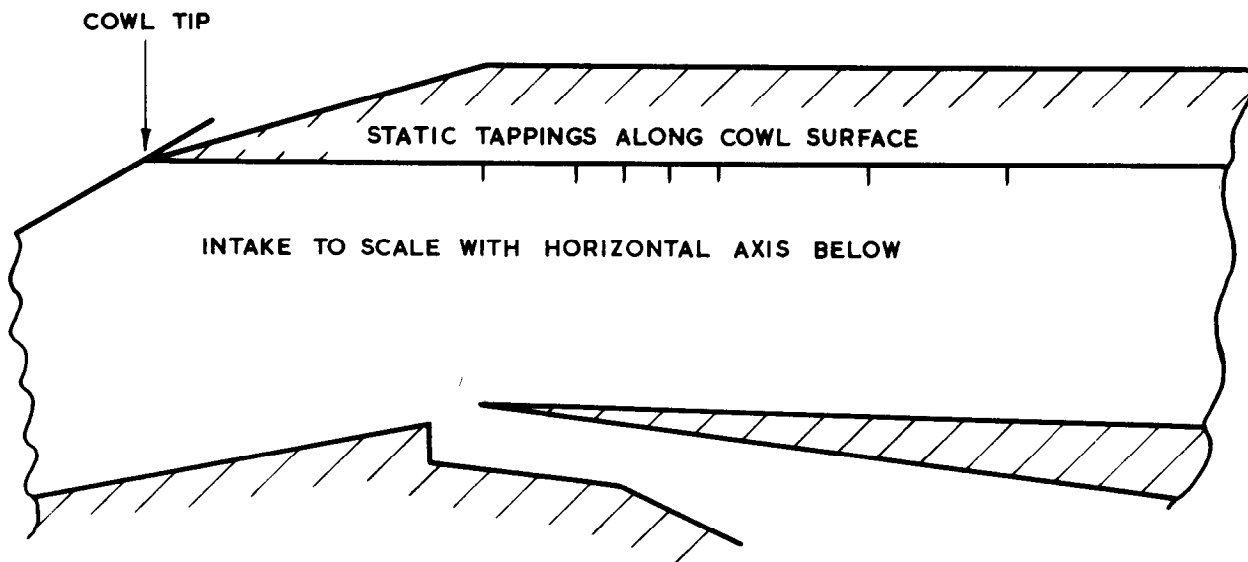

KEY

—●— 0.15" BLEED SLOT

- - \* - - 0.05" BLEED SLOT

(BLEED GAP VARIED BY MOVING THE SUBSONIC DIFFUSER TIP)

**COWL MACH NUMBER DISTRIBUTION**  
**INTAKE SUPERCRITICAL - STEP BLEED**

**FIG.16.**

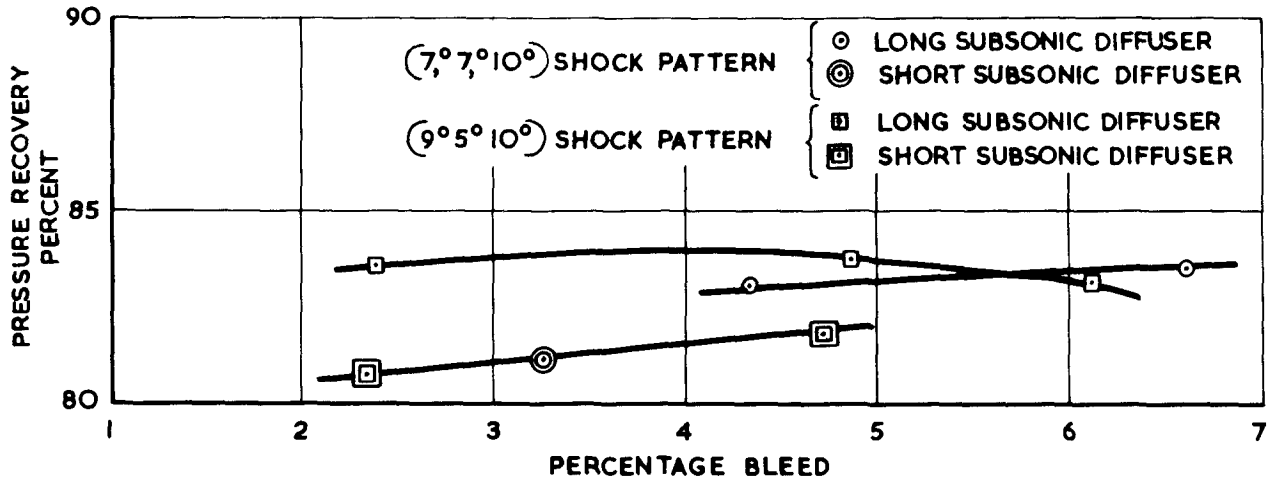

(a) ORIGINAL RAM SCOOP BLEED

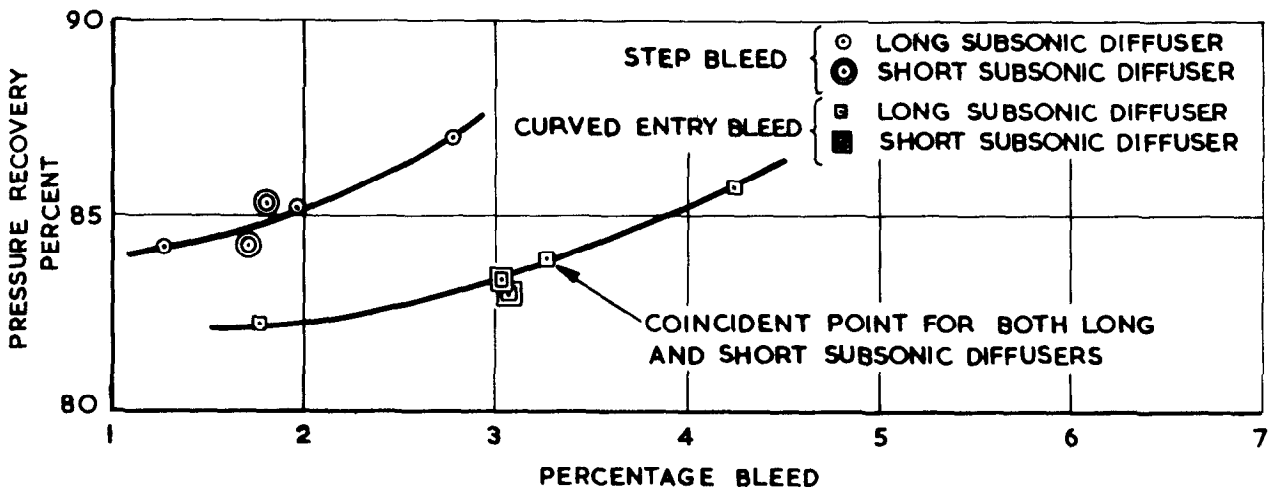

(b) MODIFIED BLEEDS

**EFFECT OF SUBSONIC DIFFUSER CHANGES**

FIG.17.

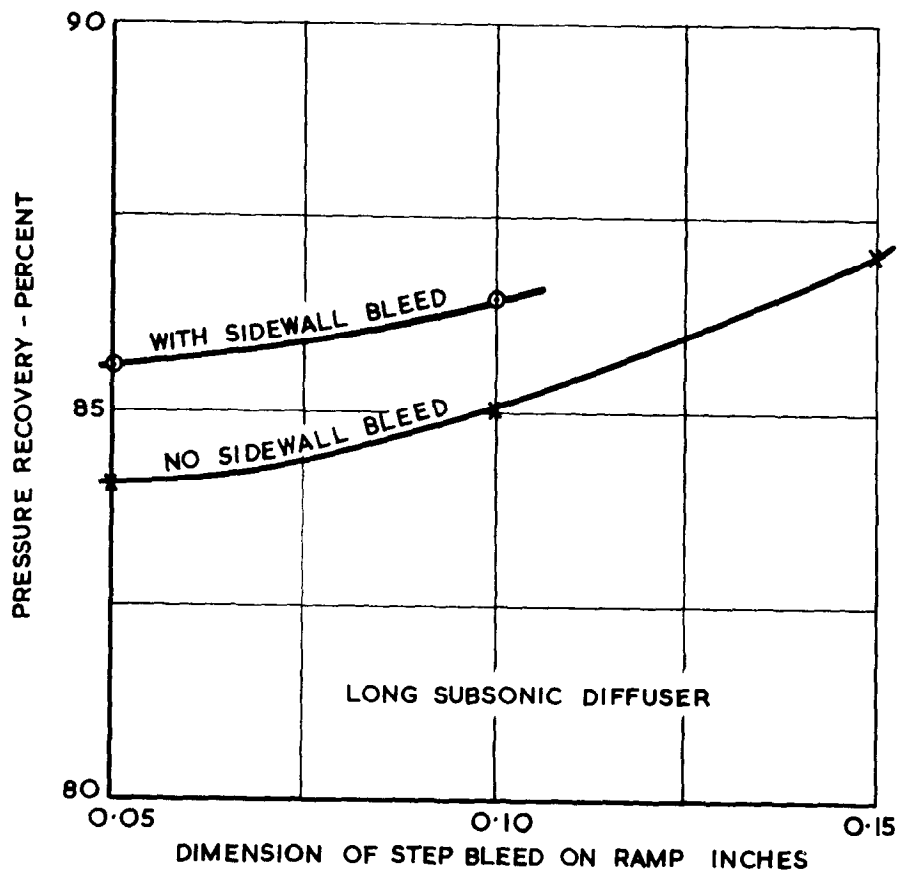

(N.B. RAMP BLEED PASSAGE VARIED BY MOVING SUBSONIC DIFFUSER TIP ; RAMP POSITION FIXED)

EFFECT OF SIDEWALL BLEED ON  
PRESSURE RECOVERY

**FIG.18.**

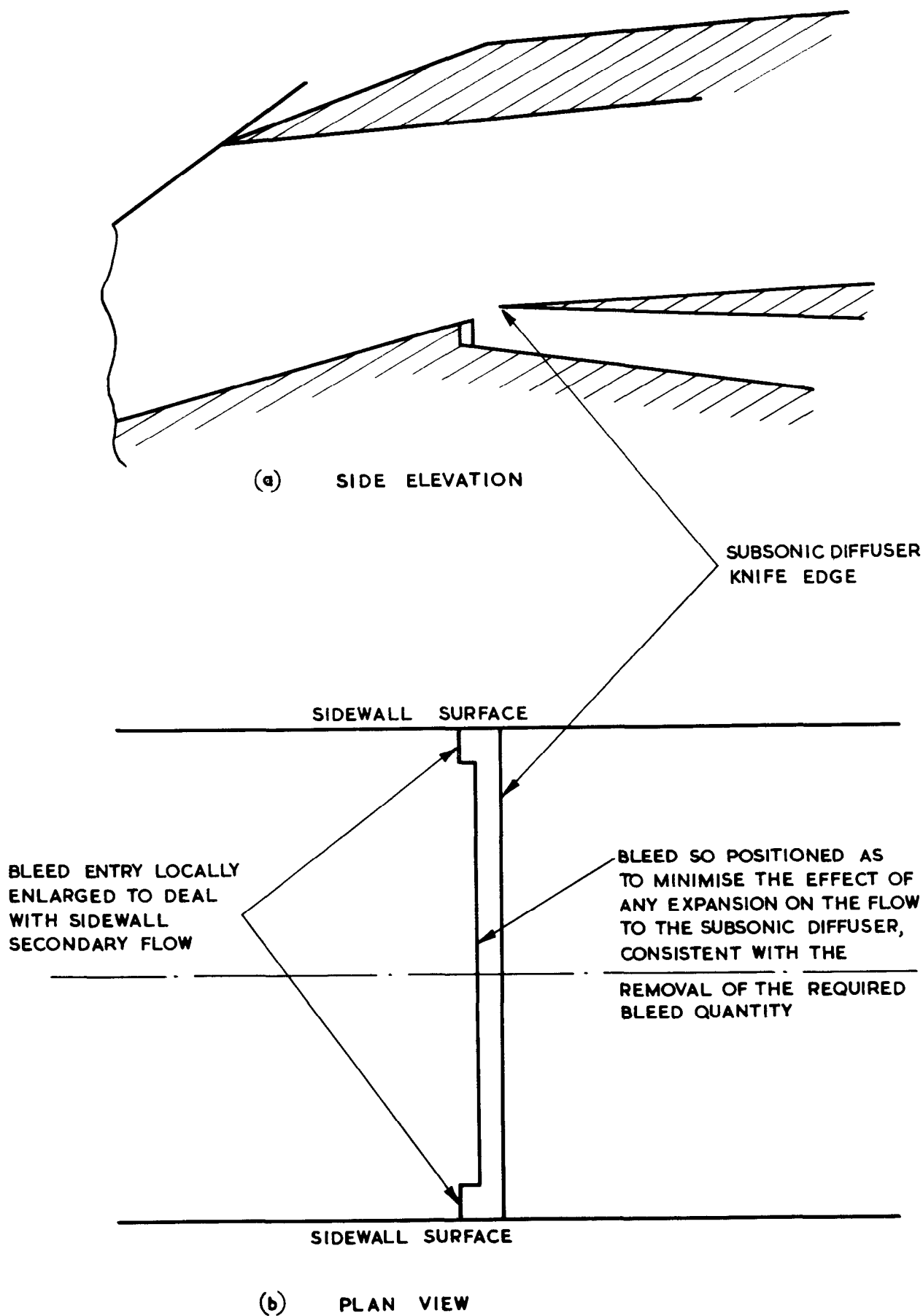

**PROPOSED RAMP BLEED SLOT**



A.R.C. C.P. No. 805  
August, 1962  
Neale, M. C. and Lamb, P. S.

533.697.2:  
533.6.011.5:  
621.438-225

TESTS WITH A VARIABLE RAMP INTAKE HAVING COMBINED  
EXTERNAL/INTERNAL COMPRESSION, AND A DESIGN MACH NUMBER OF 2.2

Results are reported of tests on a two-dimensional combined external/internal compression intake having a design Mach number of 2.2. The effects of changes in the form of the ramp bleed slot and the subsonic diffuser were examined. In addition tests were made with a crude form of sidewall bleed.

The maximum pressure recovery obtained at the design Mach number was 87 per cent with a bleed of 2.8 per cent of the capture flow.

A.R.C. C.P. No. 805  
August, 1962  
Neale, M. C. and Lamb, P. S.

533.697.2:  
533.6.011.5:  
621.438-225

TESTS WITH A VARIABLE RAMP INTAKE HAVING COMBINED  
EXTERNAL/INTERNAL COMPRESSION, AND A DESIGN MACH NUMBER OF 2.2

Results are reported of tests on a two-dimensional combined external/internal compression intake having a design Mach number of 2.2. The effects of changes in the form of the ramp bleed slot and the subsonic diffuser were examined. In addition tests were made with a crude form of sidewall bleed.

The maximum pressure recovery obtained at the design Mach number was 87 per cent with a bleed of 2.8 per cent of the capture flow.

A.R.C. C.P. No. 805  
August, 1962  
Neale, M. C. and Lamb, P. S.

533.697.2:  
533.6.011.5:  
621.438-225

TESTS WITH A VARIABLE RAMP INTAKE HAVING COMBINED  
EXTERNAL/INTERNAL COMPRESSION, AND A DESIGN MACH NUMBER OF 2.2

Results are reported of tests on a two-dimensional combined external/internal compression intake having a design Mach number of 2.2. The effects of changes in the form of the ramp bleed slot and the subsonic diffuser were examined. In addition tests were made with a crude form of sidewall bleed.

The maximum pressure recovery obtained at the design Mach number was 87 per cent with a bleed of 2.8 per cent of the capture flow.







© *Crown copyright 1965*

Printed and published by

HER MAJESTY'S STATIONERY OFFICE

To be purchased from

York House, Kingsway, London W.C.2

423 Oxford Street, London W.1

13A Castle Street, Edinburgh 2

109 St. Mary Street, Cardiff

39 King Street, Manchester 2

50 Fairfax Street, Bristol 1

35 Smallbrook, Ringway, Birmingham 5

80 Chichester Street, Belfast 1

or through any bookseller

*Printed in England*