

ROYAL AIRCRAFT ESTABLISHMENT
BEDFORD



MINISTRY OF AVIATION
AERONAUTICAL RESEARCH COUNCIL
CURRENT PAPERS

Problems Associated with the Use of a False Wall as a
Reflection Plane for Half Model Tests in the De Havilland
High Speed Wind Tunnel

By

D.R. Holder, B.Sc., and H.C. Farley, B.Sc. Eng.

LONDON: HER MAJESTY'S STATIONERY OFFICE

1962

PRICE 4s 6d NET

PROBLEMS ASSOCIATED WITH THE USE OF A FALSE WALL AS A
REFLECTION PLANE FOR HALF MODEL TESTS IN THE DE HAVILLAND
HIGH SPEED WIND TUNNEL

by

D. R. Holder, B.Sc.

and

H. C. Farley, B.Sc. Eng.

SUMMARY

The half model technique has been used extensively in the de Havilland High Speed Wind Tunnel. The false wall, as originally fitted, had a thick boundary layer, and caused disturbances in the freestream static pressure distribution. This report deals with the results of tests which led to an improved false wall arrangement, and to modifications of the transonic liner configuration. It has been found necessary to machine a knife edge chamfer at the leading edge of the false wall, to form a recess behind the false wall and to converge the transonic liners. The false wall now extends to the liners at the top and bottom. The results of investigations over a period of fifteen months should, in many cases, be applicable to tests in other tunnels. The results of these tests emphasise the importance of a thorough flow exploration, before a false wall is used for half model tests.

CONTENTS

1. Introduction
2. General Arrangement Of The Working
Section.
3. The Leading Edge Separation and
Boundary Layer Thickness.
4. Static Pressure Gradients.
5. Force Measurements.
 - 5.1. Lift Curve Slope.
 - 5.2. Drag Coefficient.
 - 5.3. Pitching Moment.
 - 5.4. Discussion.
6. Conclusion.

1. INTRODUCTION

The half model technique has two important advantages: the manufacture of the model is facilitated by the need for only one wing; a larger Reynold's number is obtained than for a complete model of the same blockage.

At the start of an extensive series of half model tests in the de Havilland High Speed Wind Tunnel, oil flow visualization indicated a flow separation near the leading edge of the false wall. A minor modification was made, but pressure of work made it necessary to continue tests without further investigation.

During later tests, with different sizes of fuselage and false wall, it became evident that flow disturbances had a significant effect on the results of half model tests. Further tests showed that, behind the separation, the boundary layer thickness on the false wall was excessive. In addition, it was shown that there were severe static pressure gradients in the freestream.

This report deals with results of tests which led to an improved false wall arrangement, and to modifications of the transonic liner configuration. The conclusions drawn from investigations over a period of fifteen months should, in many cases, be applicable to tests in other tunnels.

2. GENERAL ARRANGEMENT OF THE WORKING SECTION

The general arrangement of the transonic liners is shown in Fig. 1. The rearward location of the working section is an important consideration in section 4. During early half model tests the liners were diverged 11.5', to allow for the theoretical boundary layer growth. Perforated screens on the liner slots extended about half way back in the working section.

A short mild steel false wall was originally fitted, with its outward surface 2.13" from the tunnel wall. It was supported by curved flanges at the top and bottom, which formed ducts of constant area around a biconvex fairing for the model support shaft. Holes were drilled in the rear of the flanges, in an attempt to avoid restriction of the flow behind the false wall.

An extended false wall was fitted when the length of the half model fuselage was increased. Tests were made with the false wall supported by the curved flanges, and again with the flanges replaced by pillars.

The dimensions of the two false walls are compared in Fig. 2a. The fairing and pillars are shown in Fig. 2b. The position of the curved flanges can clearly be seen in the photograph.

The general arrangement of the working section with a new false wall is shown in Fig. 3. This false wall was the same length as the extended false wall, but its height was increased to meet the top and bottom liners. The liners were converged 54' with the perforated screens extended to the rear of the slots. A recess was formed by packing out the balance frame. Details of the recess in the tunnel wall, and the chamfer at the leading edge of the false wall are shown in Fig 4a. Fig. 4b shows the blocks which were inserted between the liners and the tunnel wall.

The location of static orifices on the extended false wall is shown in Fig. 5a. The positions at which static pressure was measured on the offset holder are indicated in Fig. 5b. The rearward positions were obtained by removal of the 6" extension piece and displacing the probe relative to the offset holder. An additional 9" extension piece was used to obtain the forward positions.

3. THE LEADING EDGE SEPARATION AND BOUNDARY LAYER THICKNESS

In an attempt to reduce boundary layer disturbances, various leading edge shapes were tried on different false walls; oilflow visualization indicated a leading edge separation in every case. The re-attachment at $M = 0.50$ was about two inches from the leading edge, see Fig 7a. The re-attachment was about two inches back from the leading edge at $M = 0.50$, and moved back with increasing Mach number. At about $M = 0.86$ a shockwave appeared at the leading edge and moved back rapidly. It was later shown that the predominant cause of the boundary layer disturbances was restriction of the flow behind the false wall. Under these conditions, the only leading edge modification to make any difference was a chamfer on the model side of the false wall, but this was later shown to produce large disturbances in the static pressure distribution.

Replacing the curved support flanges by pillars had little effect on the flow over the false wall. Oil on the back of the false wall had previously indicated that the flow had separated at the leading edge of the curved flanges; the flow now separated over the model support shaft fairing, in a manner reminiscent of the disturbance at the junction of a wing and fuselage, see Fig. 7b.

Tests were made with the false wall moved out to a distance 3.73" from the tunnel wall, and again with false wall yawed 1° out, at the trailing edge without success.

A flap at the trailing edge of the false wall, deflected 20° out reduced the disturbances, but force measurements on a half model suggested that the static pressure distribution had been disturbed over a large part of the false wall.

As mentioned above, oil on the back of the false wall indicated separated flow, and it was calculated that the reduction in effective area might cause choking at a Mach Number as low as 0.34. In an attempt to maintain constant effective area a recess was formed in the tunnel wall by packing out the balance frame 0.75", Fig. 3.

This scheme was derived from reference 1 which deals with the use of a recess behind a false wall at supersonic Mach Number.

The false wall was displaced by the same amount, leaving the leading edge 1.33" from the tunnel wall, just clear of the boundary layer on the tunnel wall. The leading edge separation was virtually eliminated and, at $M = 0.50$ the boundary layer growth was reduced to that predicted by the $1/7$ th power law of velocity distribution. However, at Mach Numbers above $M = 0.80$, the boundary layer thickness increased, and the shockwave disturbances, although considerably reduced, were still present at higher Mach Number.

The dimensions of the recess were limited by practical considerations, but tests with a short false wall indicated that this was not the cause of the remaining disturbances. After a discussion with E. W. E. Rogers of the National Physical Laboratory, it was agreed that the leading edge chamfer acted as a wedge at incidence, causing an outward deflection of the flow ahead of the false wall. Reducing the chamfer angle from 12° to 4° reduced the effective incidence, and did in fact show a little improvement at high Mach Number.

Total head traverses and boundary layer measurement are compared with those for the original configuration in Figs. 8 and 9. Boundary layer thickness is based on a 0.1" Hg difference from freestream total head, i.e. H/H_0 approximately 0.997. A trough was observed in the total head traverse at higher Mach Number. It is assumed that the depth of the trough, and its distance from the false wall indicate the magnitude and spanwise extent of shockwave disturbances.

4. STATIC PRESSURE GRADIENTS

Only a limited study was made of the freestream pressure distribution, with the original tunnel and false wall arrangement. However, it was found that the local Mach Number was 0.01 low at the working section centre, at a reference Mach Number of 0.50, and, ten inches back along the tunnel axis, the local value was 0.03 below reference Mach Number. The reference Mach Number is based on the static pressure in the lower plenum chamber.

It appears that the average Mach Number was in error, due to the pressure drop associated with the crossflow through the liner slots. Due to its rearward location, the working section was affected by an increase in crossflow near the liner trailing edge. Uniform flow along the tunnel axis was achieved by converging the liners 20', and extending the perforated screens to the rear of the slots, Fig. 3. Local Mach numbers based on static pressure measurements with the liners converged 20' are shown in Fig. 10. The freestream measurements were made with a static probe mounted on an offset holder, Fig. 5b. It is now known that absolute values were in error due to interference, but the gradients indicated should be accurate.

Mach Number was high near the leading edge, and near the trailing edge of the falsewall. An improved fairing had been fitted, when the liners were converged, and the separations behind the false wall were considerably reduced. Tests with the short false wall proved that the gradients were not due to restriction of the flow behind the false wall. Later tests indicate that the gradient near the trailing edge of the false wall was due, in some way, to the gaps between the liners and the false wall, at the top and bottom. With these gaps sealed there was a steady drop in Mach Number along the length of the false wall, see Fig 10. It may be that such a gradient is inevitable when a flat plate, with a chamfered leading edge, is inserted in a uniform stream. A similar gradient was observed on a false wall at N.P.L. The liners were further converged to establish a gradient of opposite sign, thus removing the gradient along the false wall.

During subsequent tests with a half model, tunnel power requirements decreased with increasing incidence of the model. Further tests indicated that this was due to flow into the plenum chamber from behind the false wall; the recess had formed a gap between the converged liners and the tunnel wall. The blocks which were inserted to seal this gap are shown in Fig. 4b.

A new false wall was fitted which extended to the liners, when the latter were converged 54'. The gradient near the tunnel axis was considered to be preferable to one over the length of the half model fuselage. The transverse gradient was small in the region occupied by the wing, and it was estimated that local Mach Number was within ± 0.0025 in the region occupied by the half model. Unfortunately, it was later found that a gradient existed as near as 1.25" from the false wall, indicating that the liner convergence was excessive. The gradient increased in magnitude, from zero at $M = 0.50$ to 0.00055 in Mach Number per inch at $M = 0.86$. However, it is possible to apply a correction to drag coefficient to allow for this gradient.

5. FORCE MEASUREMENTS

The aerodynamic characteristics most affected by modifications to the tunnel and false wall arrangement were lift curve slope and drag coefficient. In many cases force measurements were made at one incidence only, as the emphasis was on drag measurements at low C_L

The effect of the recess on $C_L - \alpha$, $C_m - C_L$ and $C_D - C_L$ at a low Mach Number is shown in Fig. 12.

5. 1. Lift Curve Slope

The recess in the tunnel wall, the improved fairing for the model support shaft and liner convergence each gave an increment in lift curve slope. A slight reduction was measured on extending the false wall to the liners.

5. 2. Drag Coefficient

With severe leading edge disturbances and thick boundary layer on the false wall, measured drag coefficients varied with changes in the relative dimensions of the fuselage and the false wall, Fig. 13a. Clearly such conditions were unacceptable.

Figure 13 shows the increase of drag coefficients measured with a recess in the tunnel wall, i.e. with reduced boundary layer thickness on the false wall. The total effect of the modifications to the tunnel and false wall arrangement can be seen in Fig. 13c.

Variations of the gap between the half model fuselage and the false wall has a considerable effect on lift curve slope and drag coefficient. Results of tests, Fig. 12d, were sufficiently consistent to allow correction to zero gap. Boundary constraint; the pressure gradient remaining in the region occupied by the half model fuselage; and the effect of artificially fixing transition to turbulence in the boundary layer necessitate further corrections to force measurements. It is important to note that the upwash constraint is nearer that for an open boundary for a half model, than for a complete model, and the open boundary correction is about twice as large for a half model. The effect of the above corrections on drag coefficients measured with the final configuration are shown in Fig. 12e.

5. 3. Pitching Moment

There were no obvious trends in pitching moment characteristics. The results are in good agreement within the limits of repeatability.

5. 4. Discussion

It appears that separated flow near the leading edge of the false wall caused a suction at the nose of the fuselage with a consequent reduction in drag. Under these conditions a displacement of the fuselage relative to the leading edge of the false wall caused large changes in drag measurements. The change of drag with increasing Mach Number was affected by growth of the separation.

According to section 3 of reference 2 the reduced velocity in the boundary layer causes a local reduction in lift and drag. On the other hand the reduction in lift will increase the strength of the trailing vortex at the junction of the wing and fuselage, resulting in an induced drag, and a downwash, which will affect tests with a tailplane and with a rear engine configuration. Results of tests indicate that the first effect is predominant

The total effect of the static pressure gradients with the original tunnel and false wall arrangement, was a reduction in measured drag, especially at low Mach number.

The corrected results with the final configuration are considered reliable. Comparison will be made in the near future, with results of complete model tests.

6. Conclusion

The results of these investigations emphasise the importance of a thorough flow exploration, before a false wall is used for half model tests.

Acknowledgments.

The authors are indebted to the Directors of the de Havilland Aircraft Company for permission to publish this report. They would like to thank Mr. E. W. Rogers of the National Physical Laboratory for his suggestions and encouragement, and the members of the Wind Tunnel Staff, who assisted in the preparation of this report.

References:

1. A. O. Omerod. An investigation of the disturbances caused by a reflection plate in the working section of a supersonic wind tunnel. A.R.C. R. & M.2799. November, 1950.
2. J. A. Van der Bliek. Notes on half model testing in wind tunnels N.A.L. Canada. Lab.Rep. 265. January, 1959.

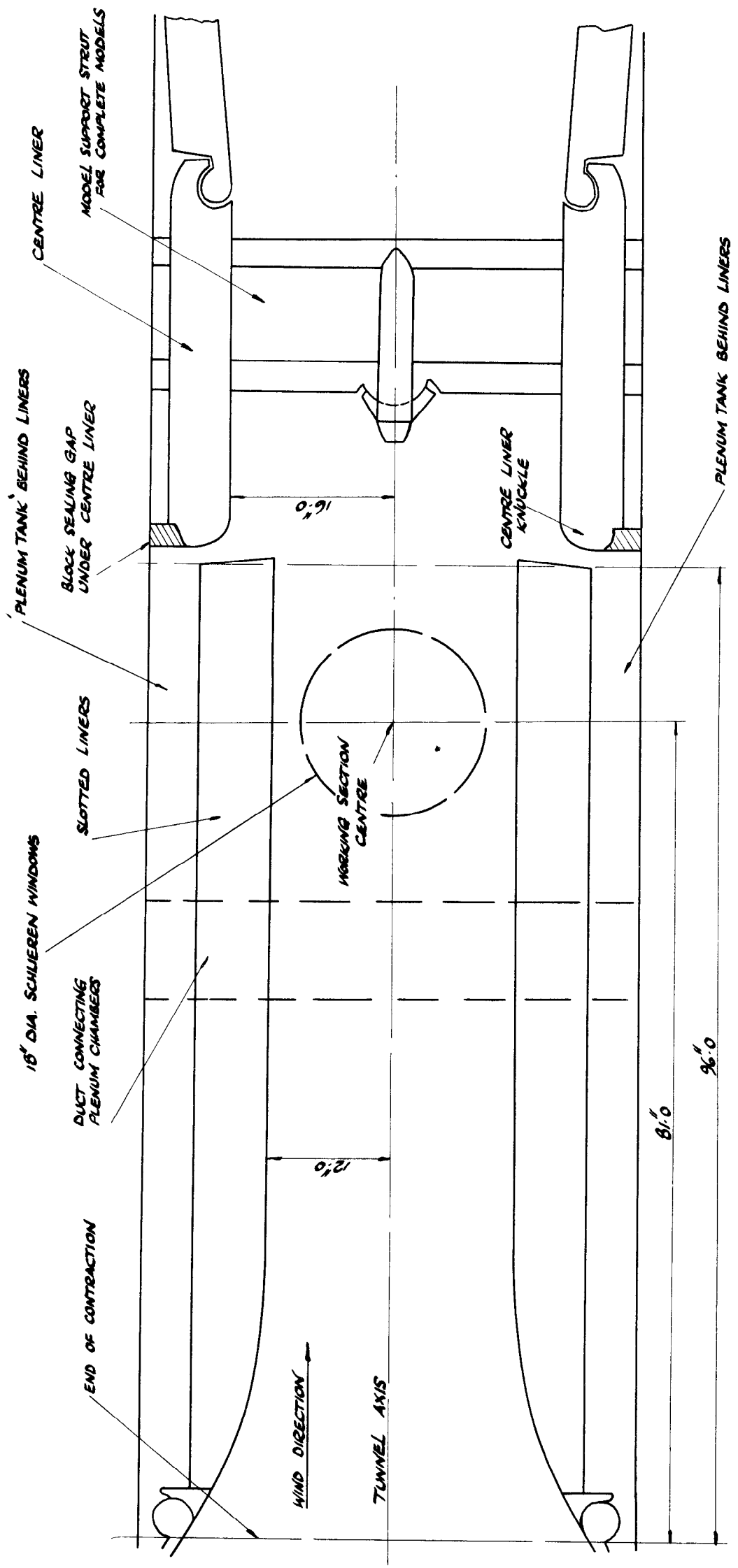

ARRANGEMENT OF THE TRANSONIC LINERS

FIG 2a.

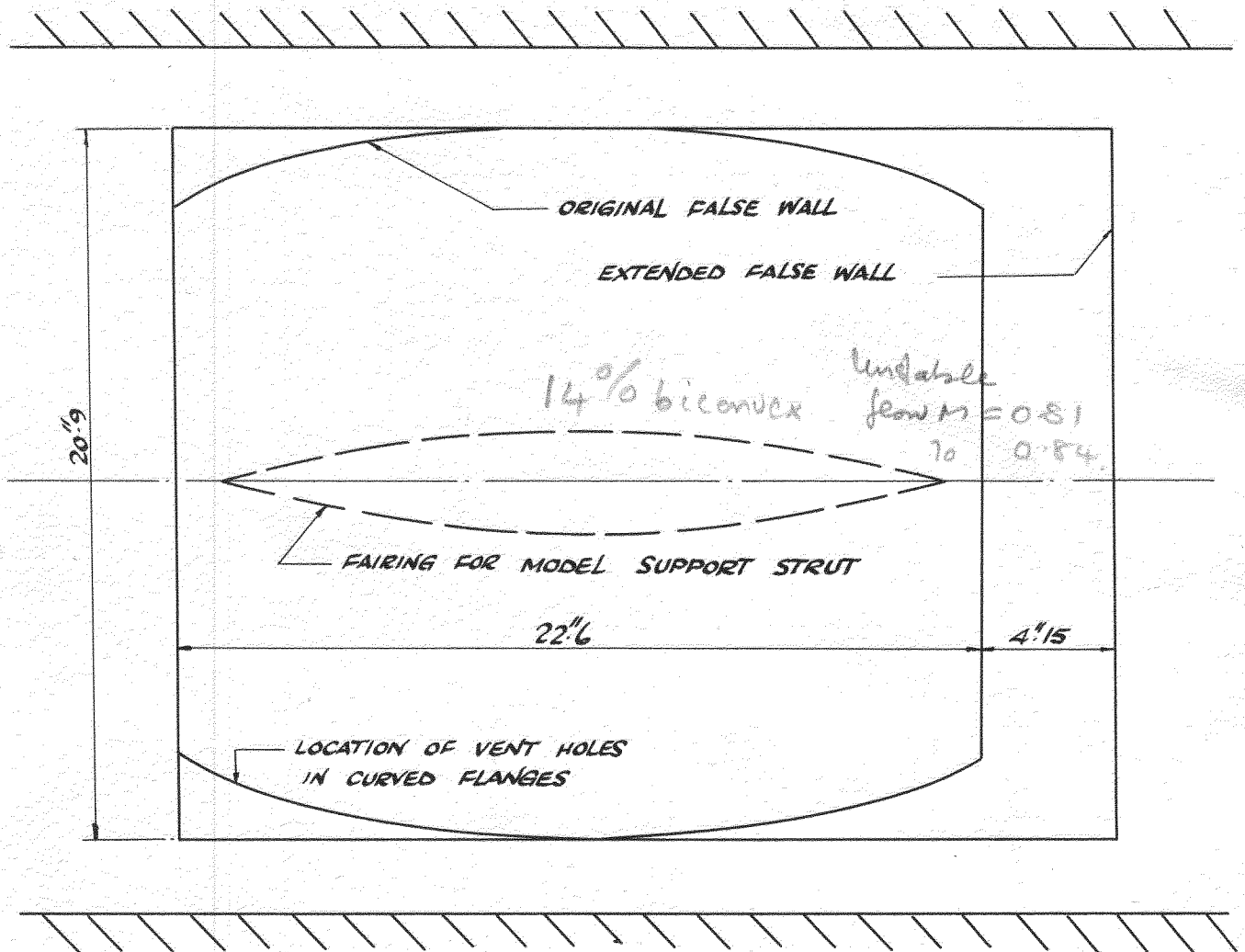

DIMENSIONS OF THE ORIGINAL AND EXTENDED FALSE WALLS

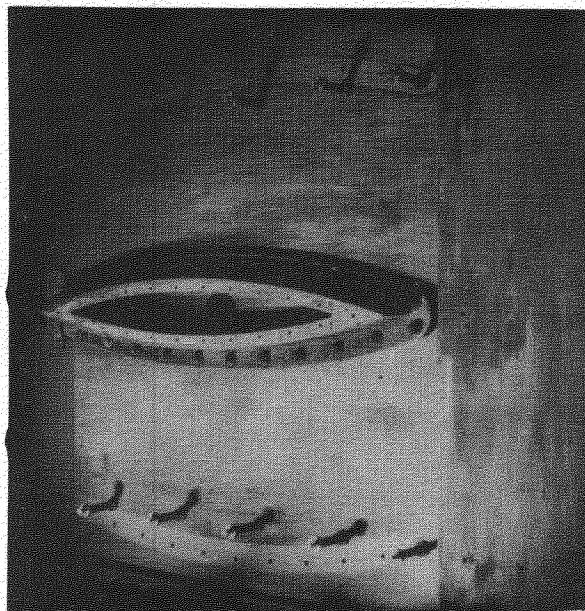

FIG 2B

THE ORIGINAL FAIRING AND PILLARS
USED TO SUPPORT THE EXTENDED
FALSE WALL.

(THE LOCATION OF THE CURVED
FLANGES CAN BE EASILY SEEN
IN THE PHOTOGRAPH)

SCALE : 1/2 FULL SIZE

FIG 3

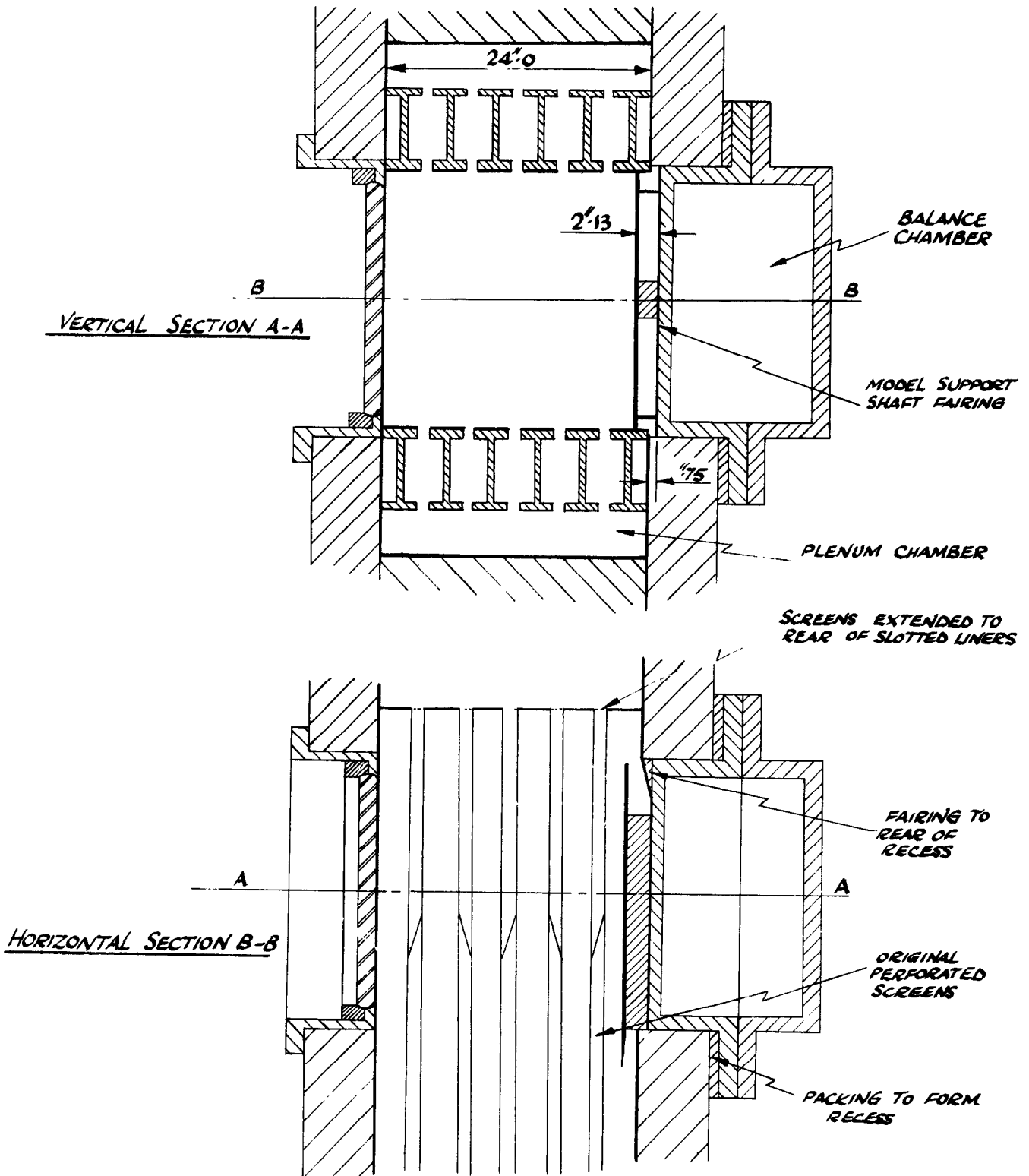

GENERAL ARRANGEMENT OF THE TRANSONIC WORKING SECTION FOR HALF MODEL TESTS - IMPROVED ARRANGEMENT

FIG 4a

SCALE: FULL SIZE

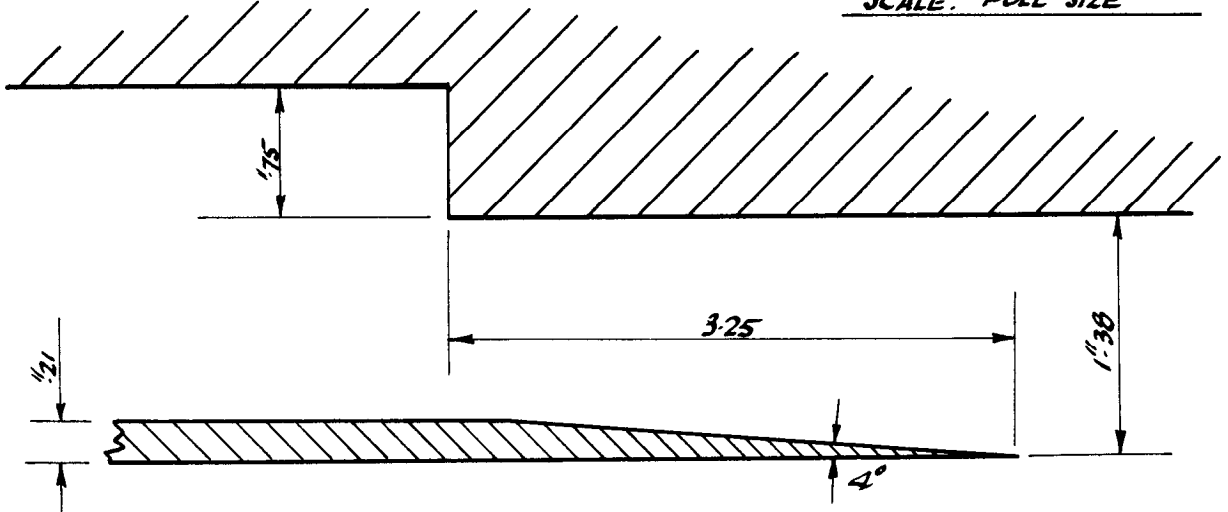

DETAILS OF RECESS AND FALSE WALL LEADING EDGE

FIG 4b

SCALE: FULL SIZE

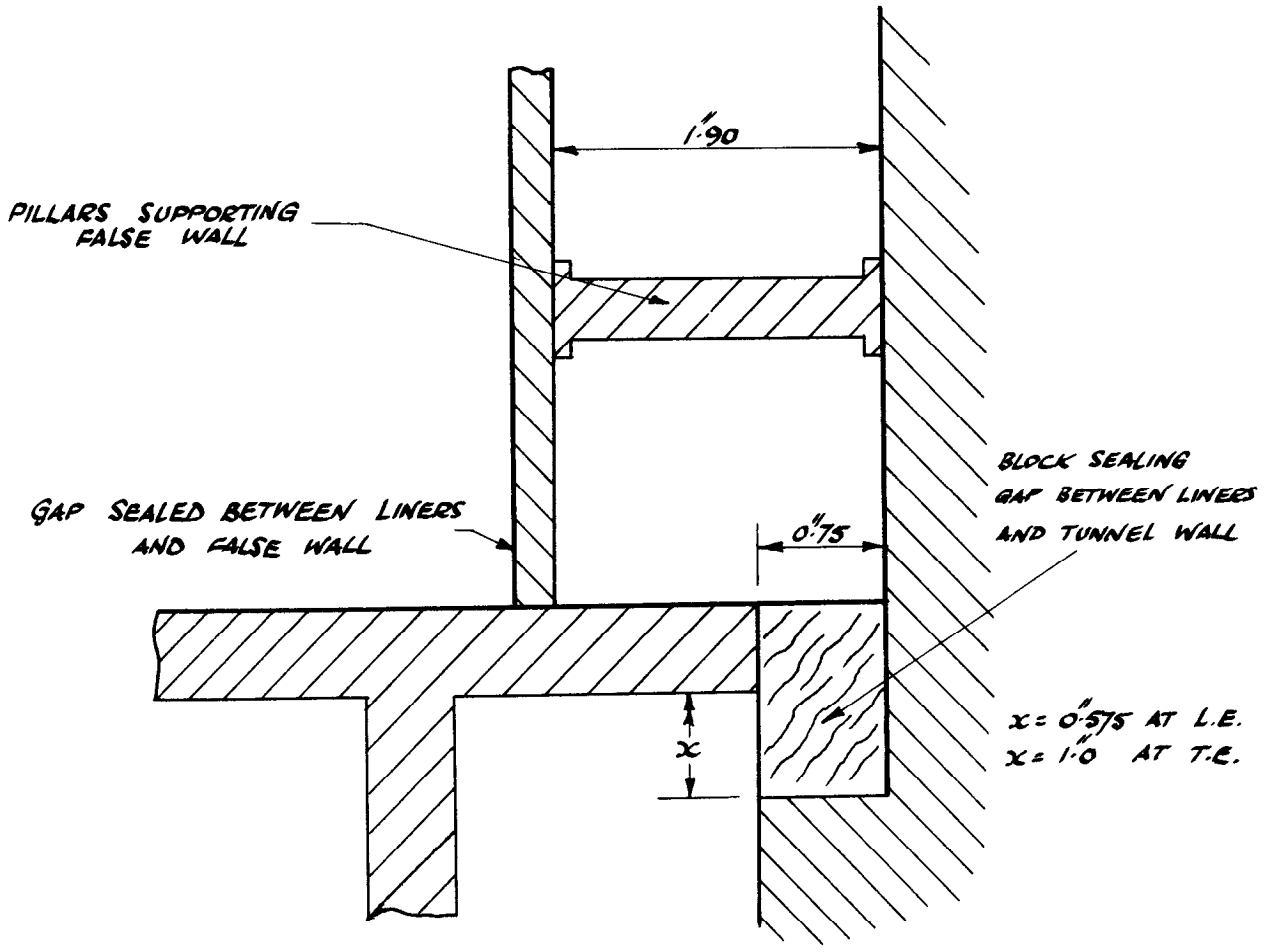

DETAILS OF BLOCKS BETWEEN LINERS AND TUNNEL WALL

FIG 5A.

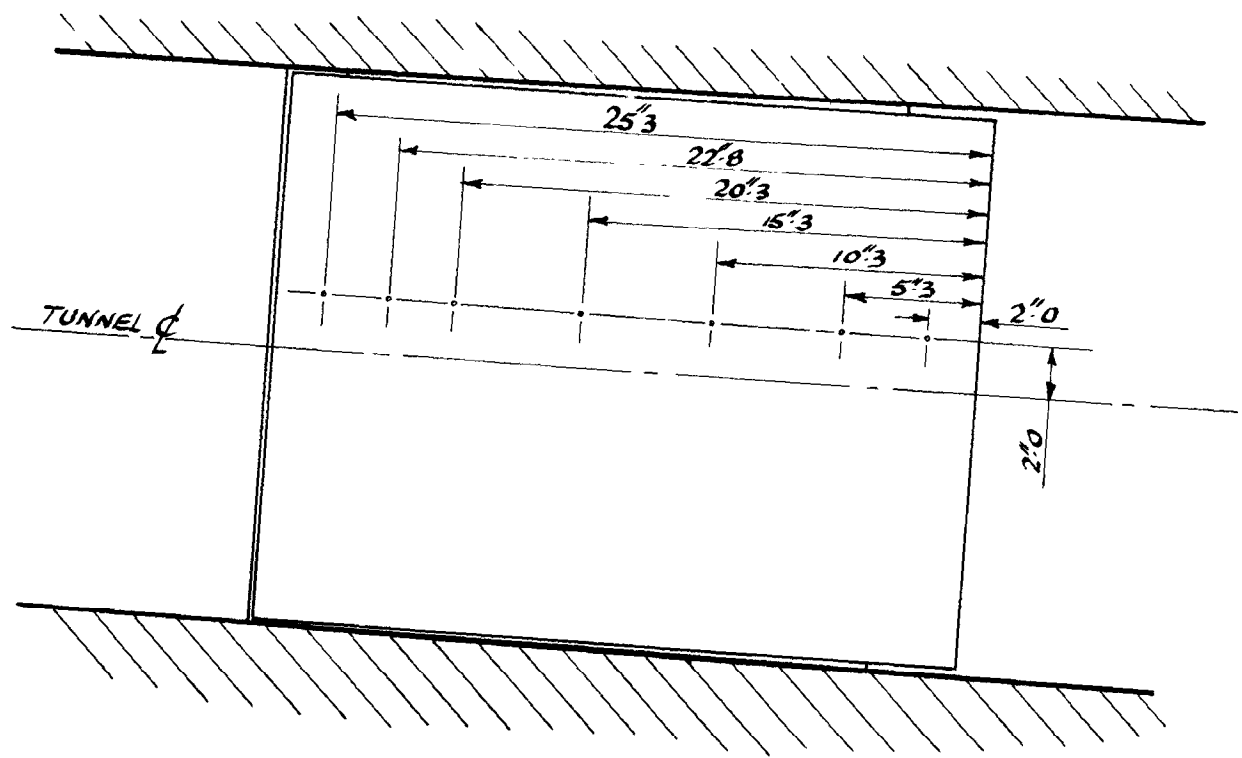

LOCATION OF STATIC ORIFICES ON THE EXTENDED FALSE WALL

X - MEASURING STATIONS

FIG 5B.

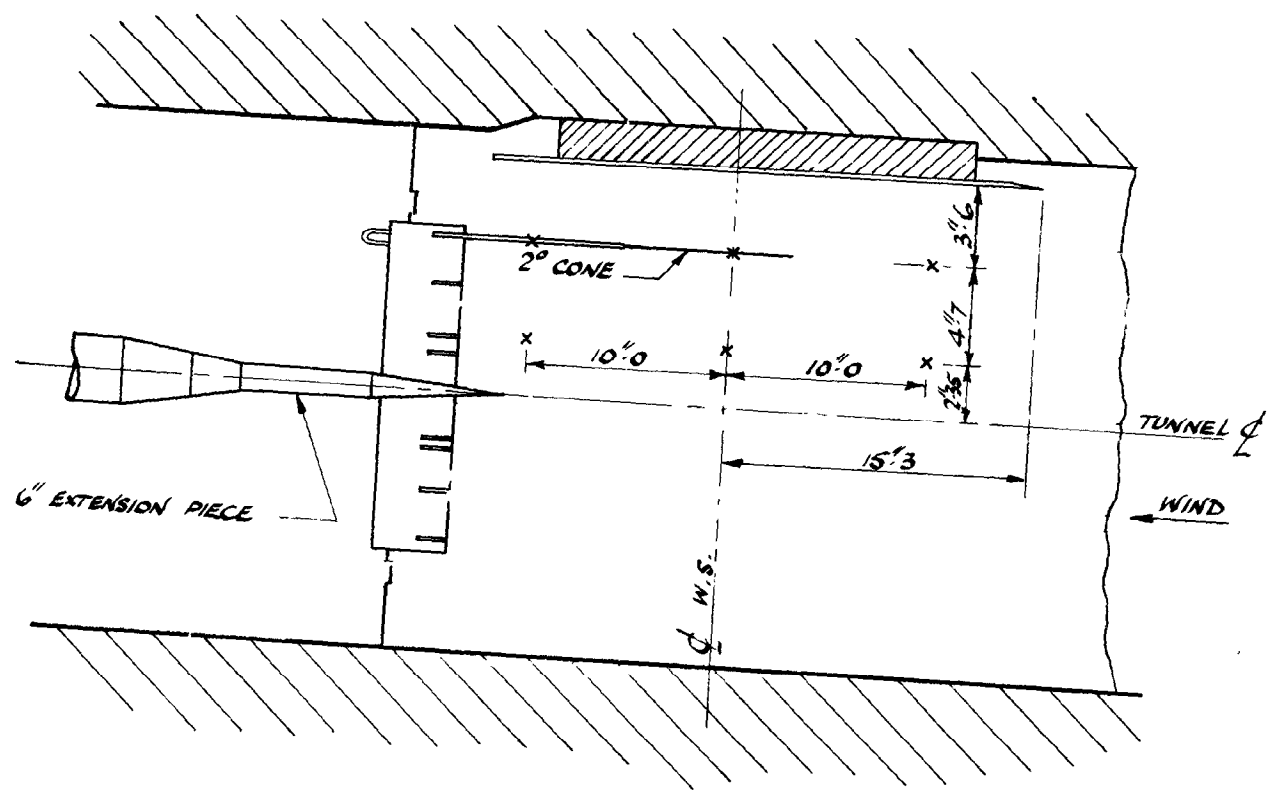

MEASURING STATIONS WITH THE STATIC PROBE ON THE OFFSET HOLDER

SCALE : 1/4 MODEL SIZE

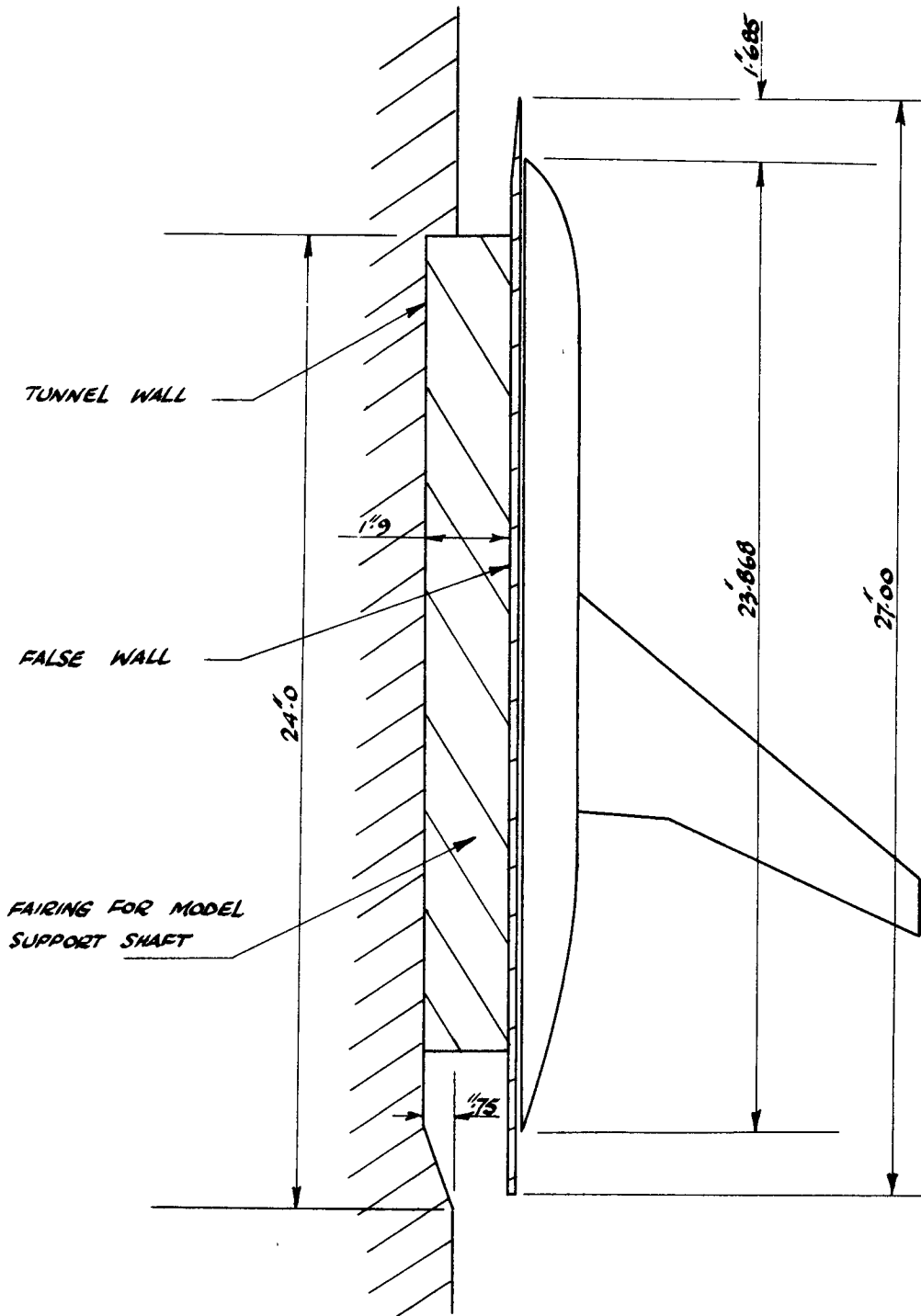

GENERAL ARRANGEMENT OF HALF MODEL

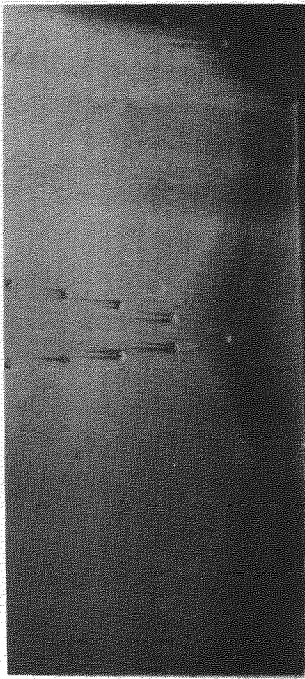

M = 0.50
SEPARATION

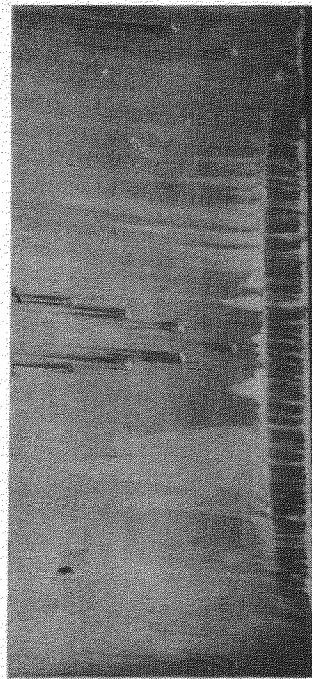

M = 0.86
SHOCK WAVE

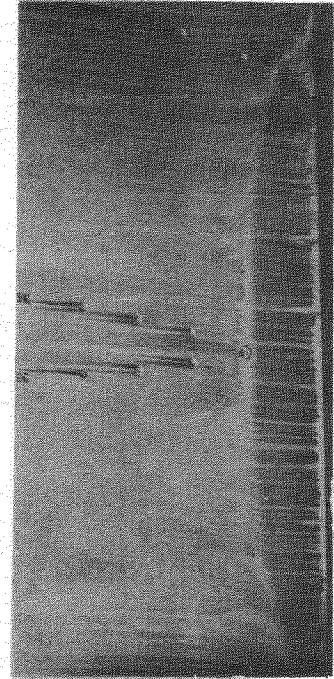

M = 0.92
SHOCK WAVE

FLOW DISTURBANCES AT THE LEADING EDGE OF THE FALSE WALL*

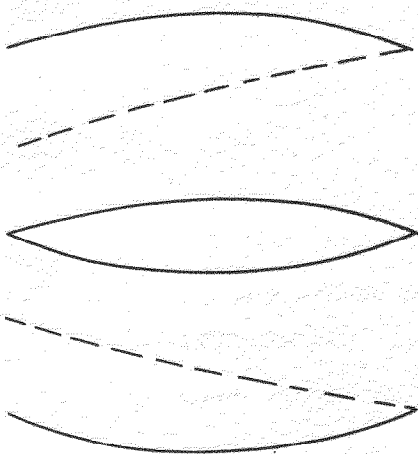

SEPARATION OFF CURVED FLANGES

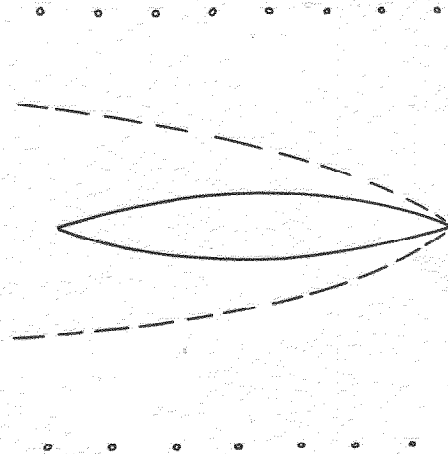

SEPARATION OFF ORIGINAL FAIRING

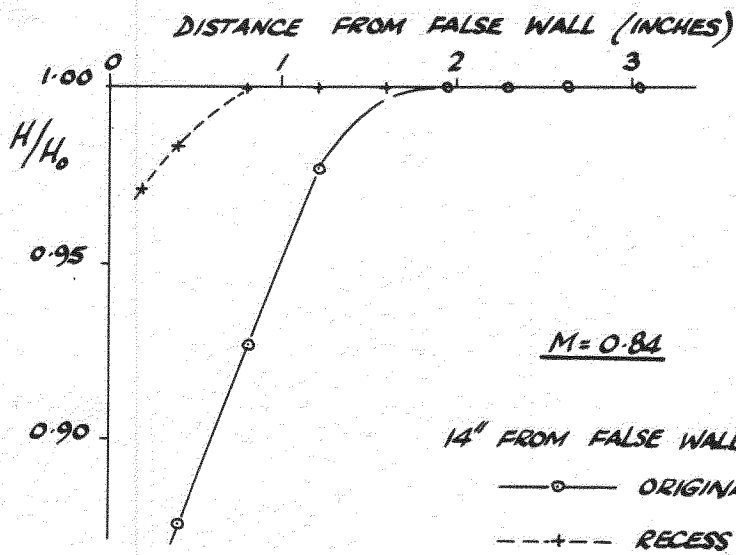
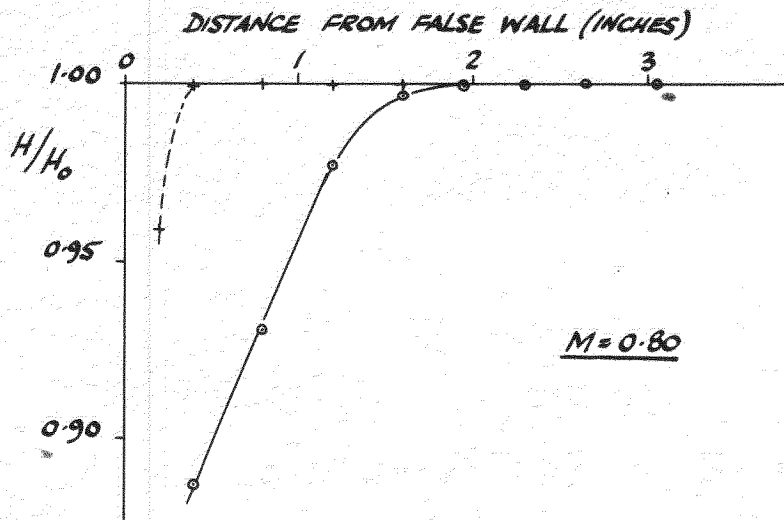
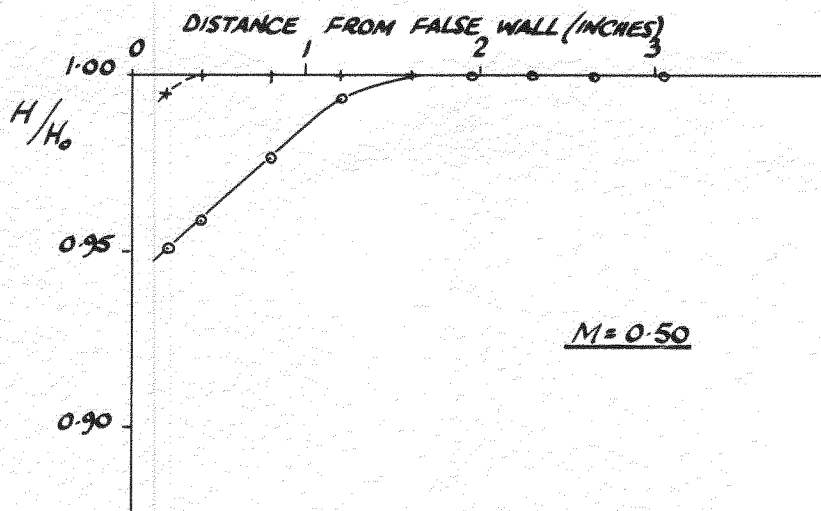

BOUNDARY LAYER TRAVERSES ON EXTENDED FALSE WALL

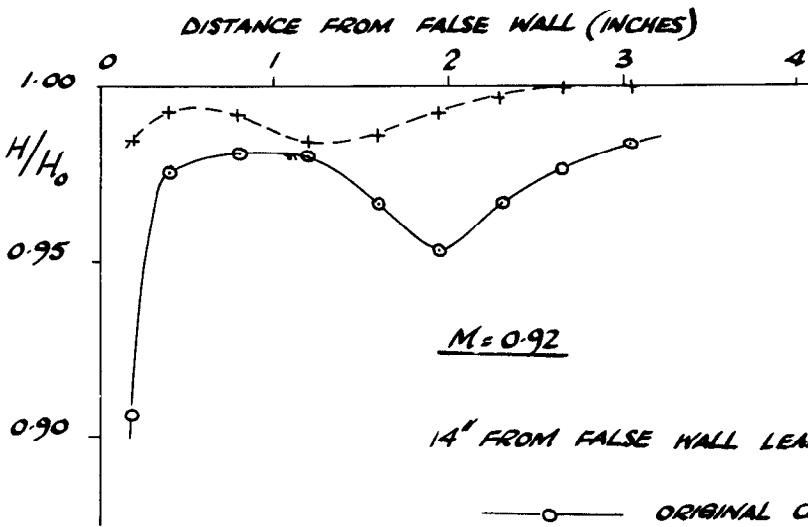
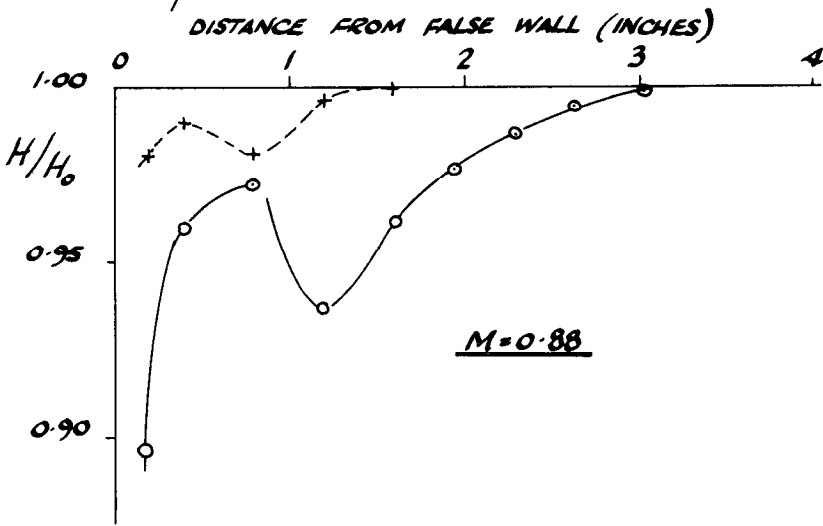
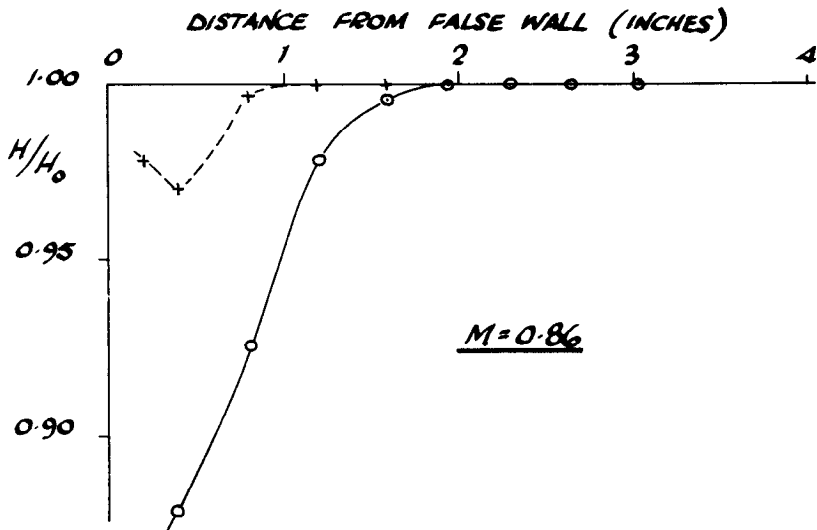

BOUNDARY LAYER TRAVERSES ON EXTENDED FALSE WALL

ORIGINAL CONFIGURATION

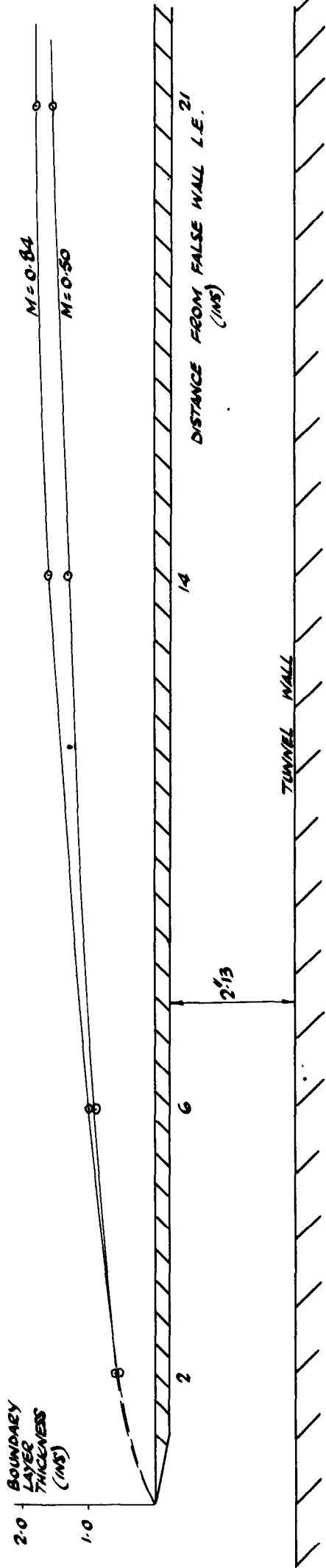

RECESS IN TUNNEL WALL

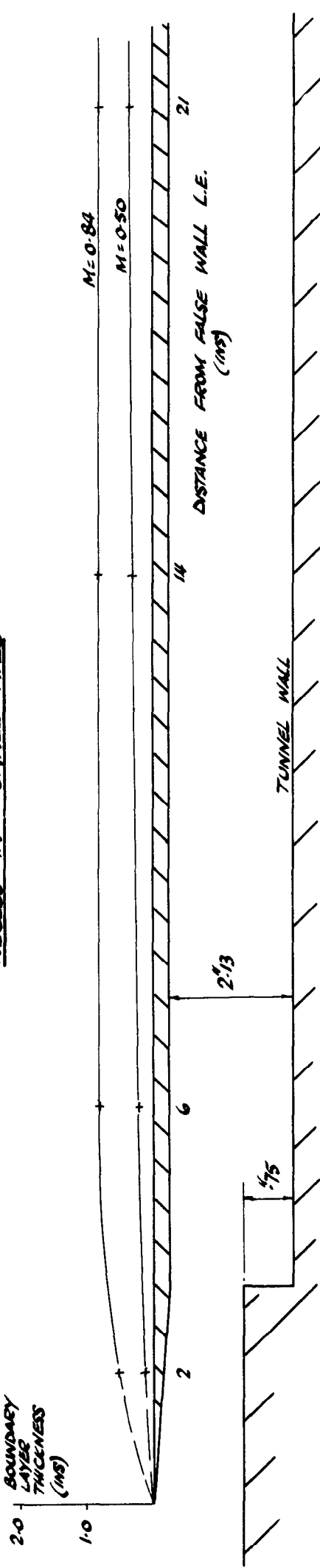

BOUNDARY LAYER GROWTH ALONG EXTENDED FALSE WALL

BOUNDARY LAYER DISTRIBUTION AT $N = 0.88$

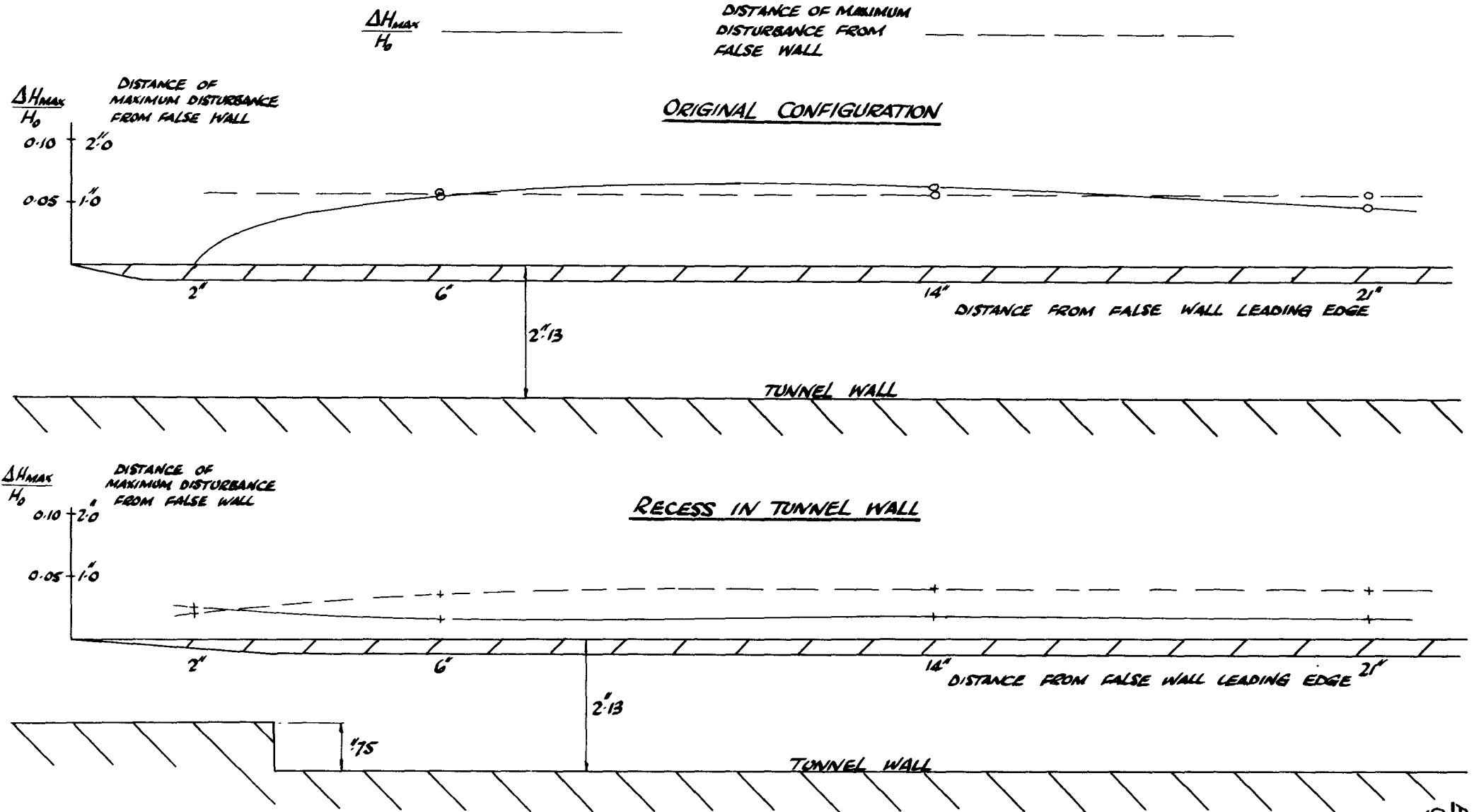

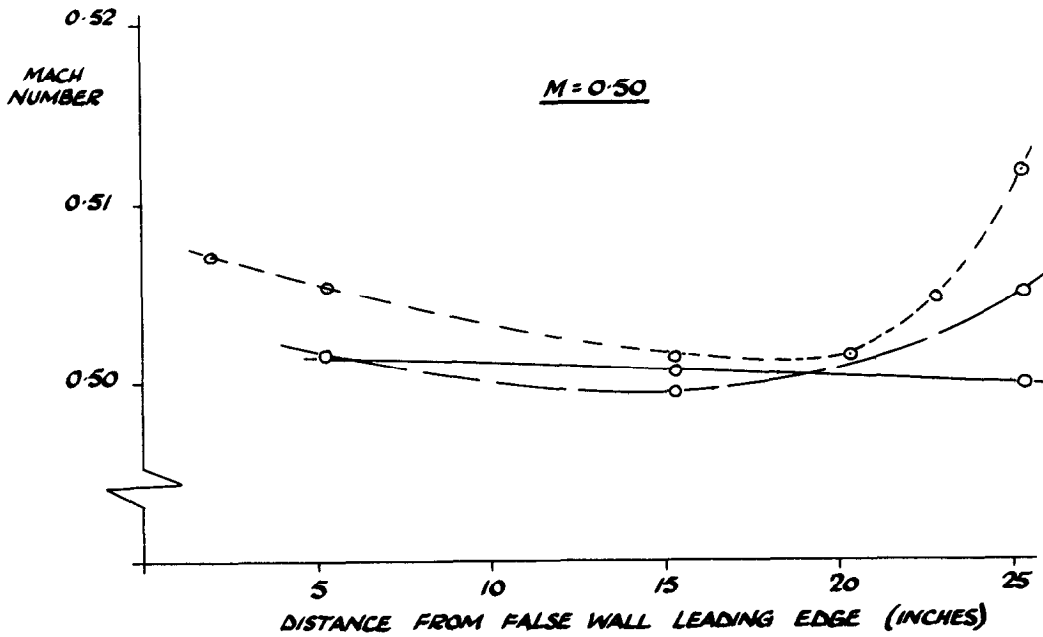

——— 2³/₈ FROM TUNNEL AXIS
 - - - 3¹/₆ FROM FALSE WALL
 - - - FALSE WALL ORIFICES

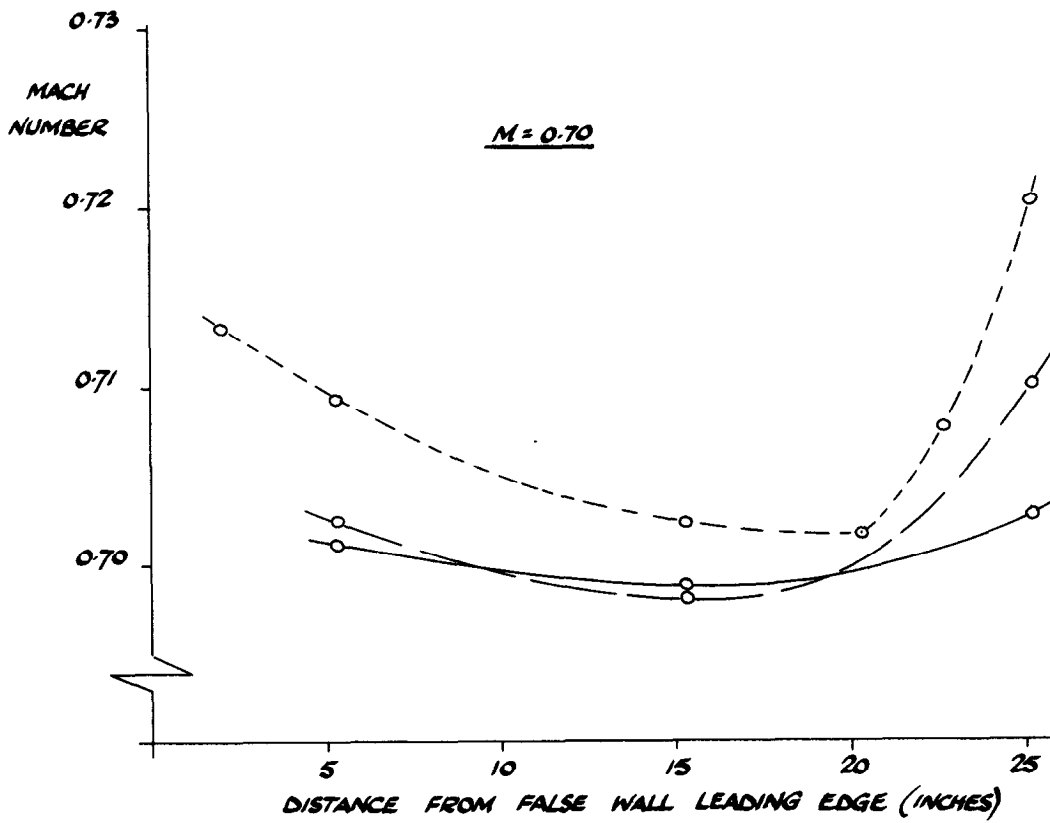

MACH NUMBER DISTRIBUTION WITH THE EXTENDED FALSE WALL

LINERS CONVERGED 20', RECESS IN TUNNEL WALL

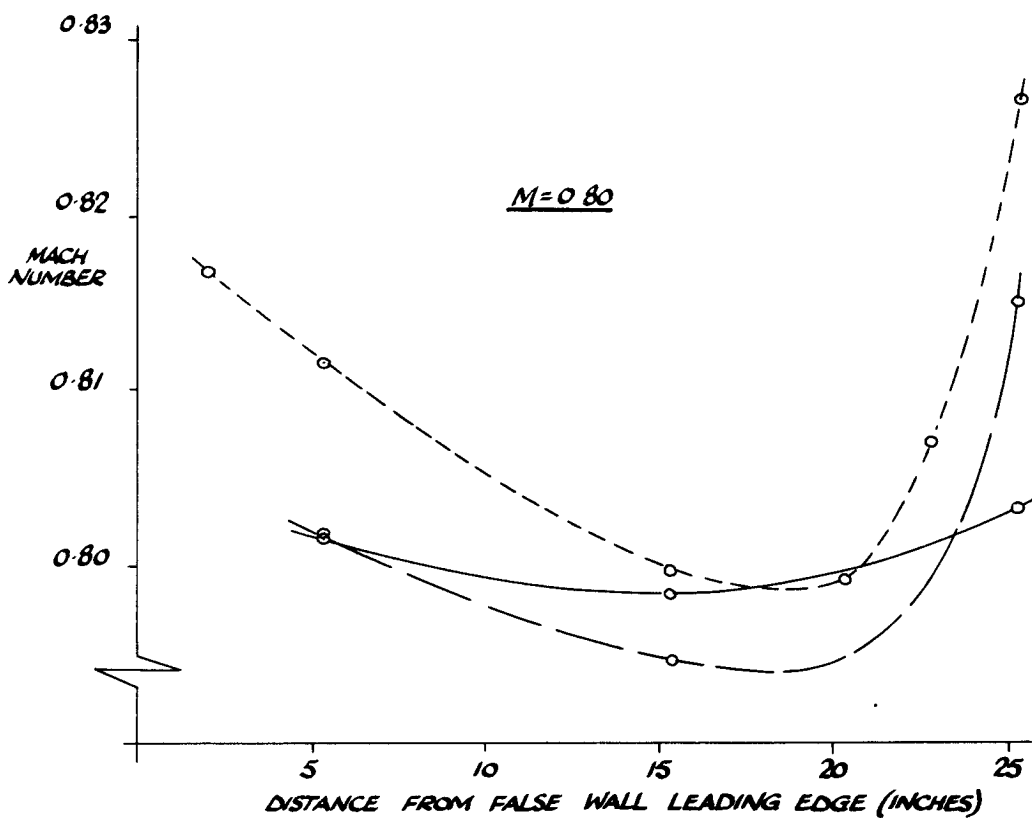

——— 2.35 FROM TUNNEL AXIS
 - - - - 3.6 FROM FALSE WALL
 - · - · FALSE WALL ORIFICES

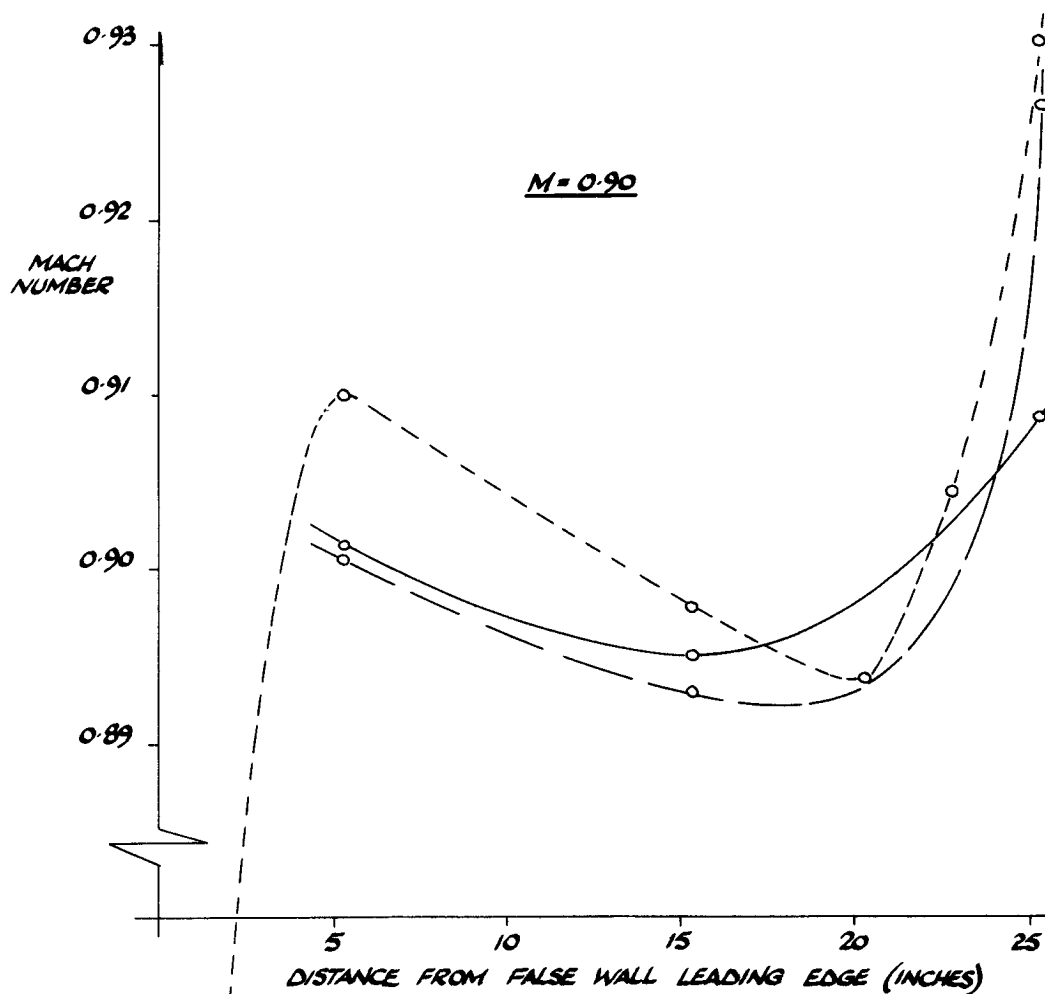

MACH NUMBER DISTRIBUTION WITH THE EXTENDED FALSE WALL
LINERS CONVERGED 20', RECESS IN TUNNEL WALL

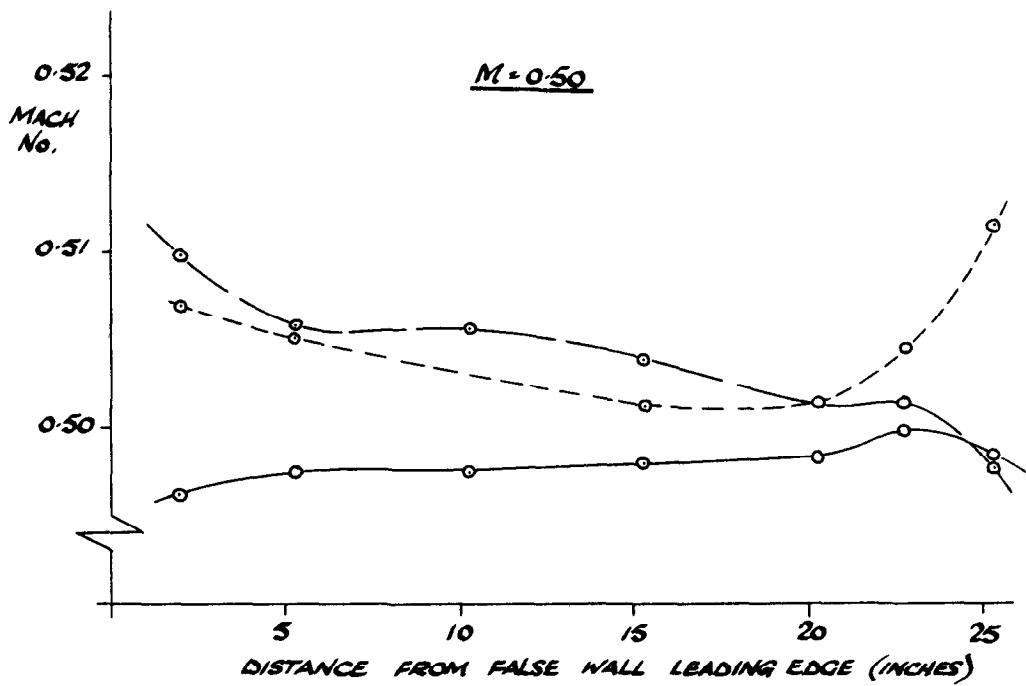

----- LINERS CONVERGED 20'
 - · - · - · LINERS CONVERGED 20' } FALSE WALL
 ----- LINERS CONVERGED 54' } EXTENDED
 TO LINERS

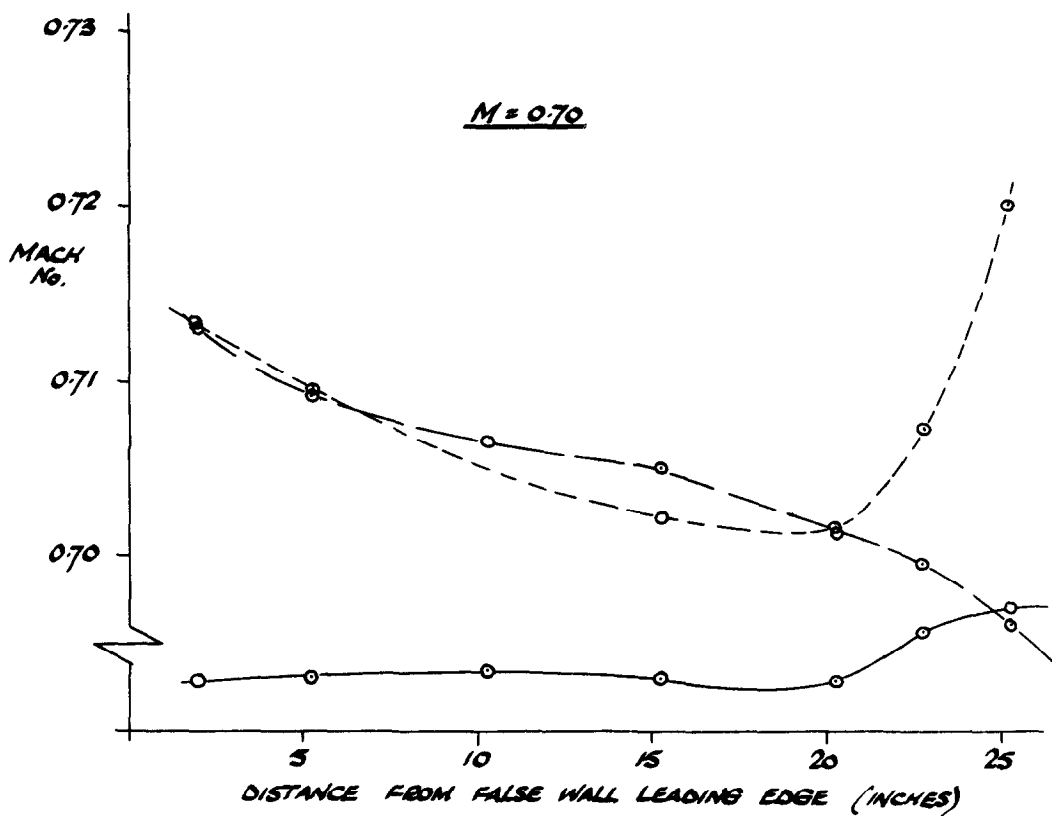

EFFECT OF CONVERGING THE LINERS AND OF EXTENDING
THE FALSE WALL TO THE LINERS
MACH No. DISTRIBUTION AT FALSE WALL ORIFICES

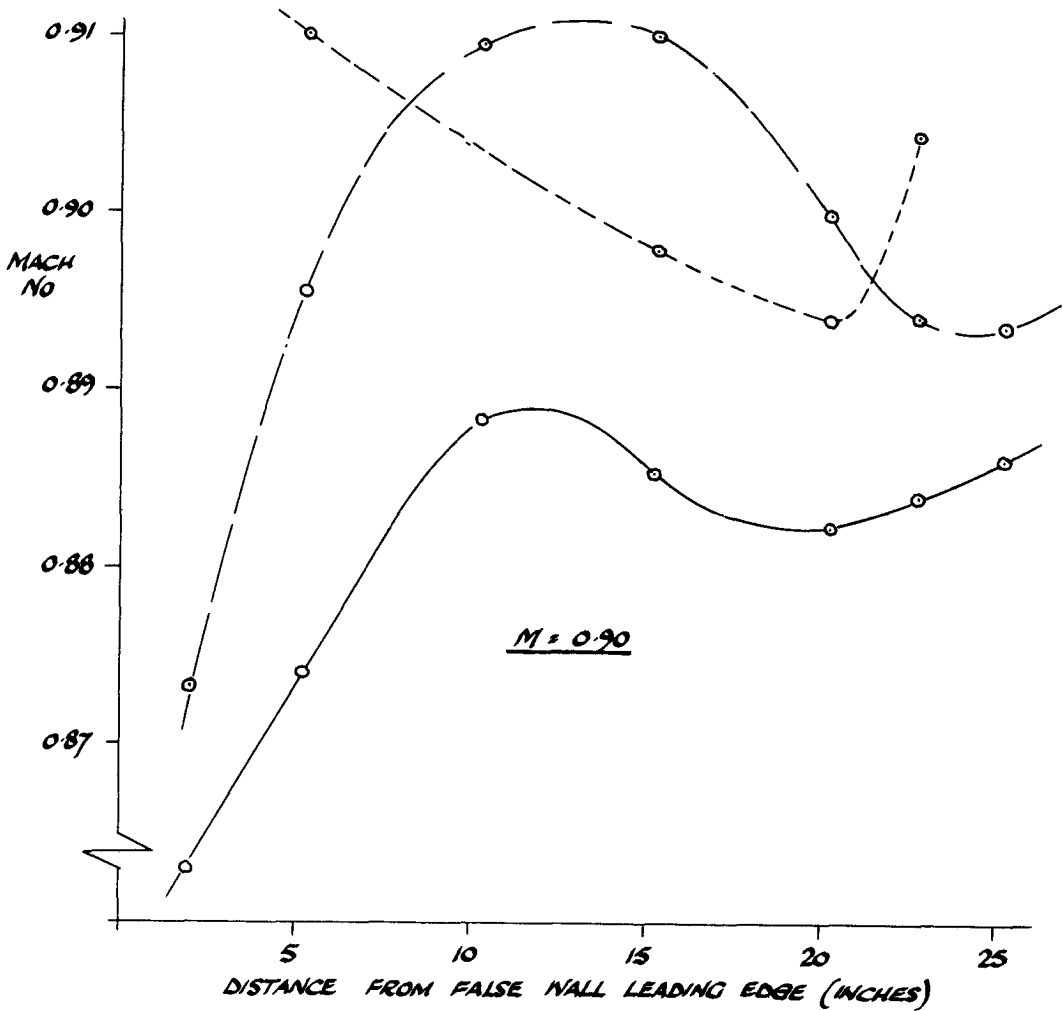
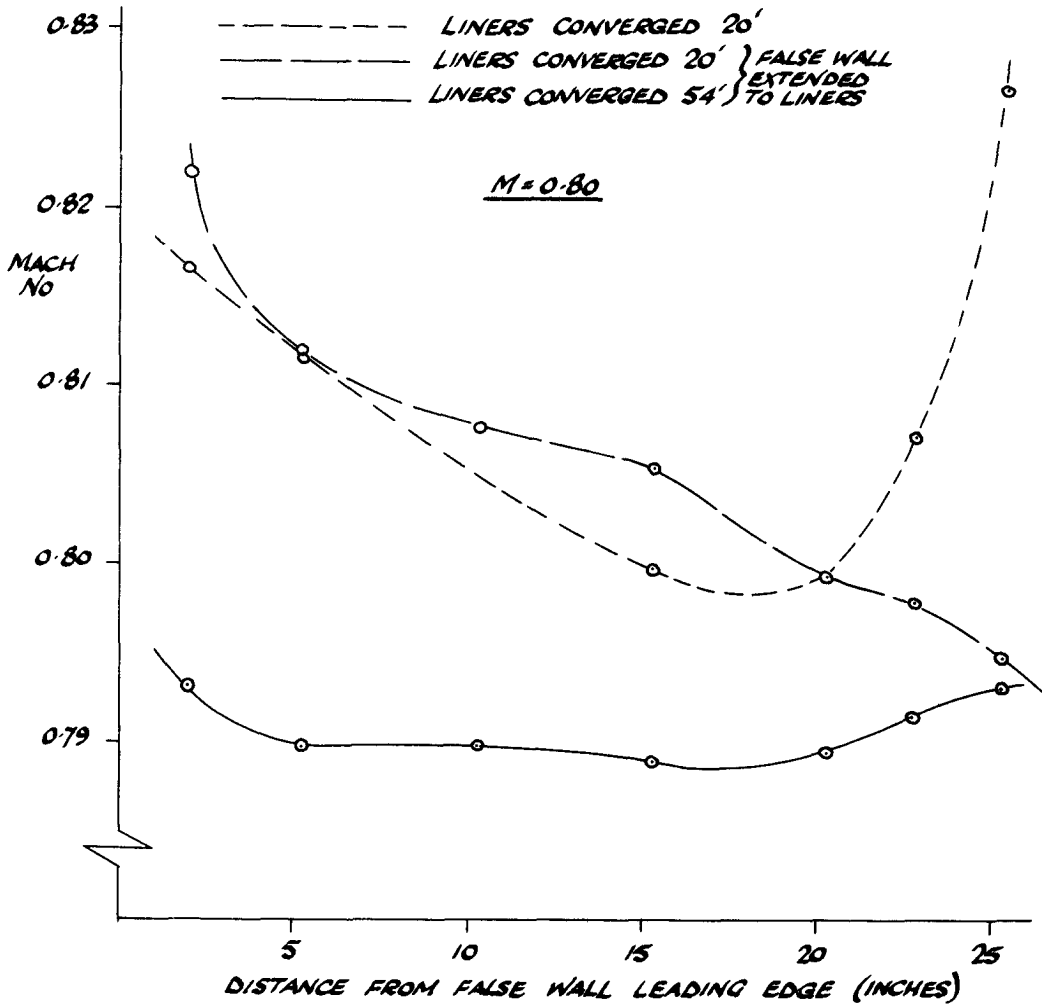

EFFECT OF CONVERGING THE LINERS AND OF EXTENDING THE FALSE WALL TO THE LINERS
MACH NO. DISTRIBUTION AT FALSE WALL ORIFICES

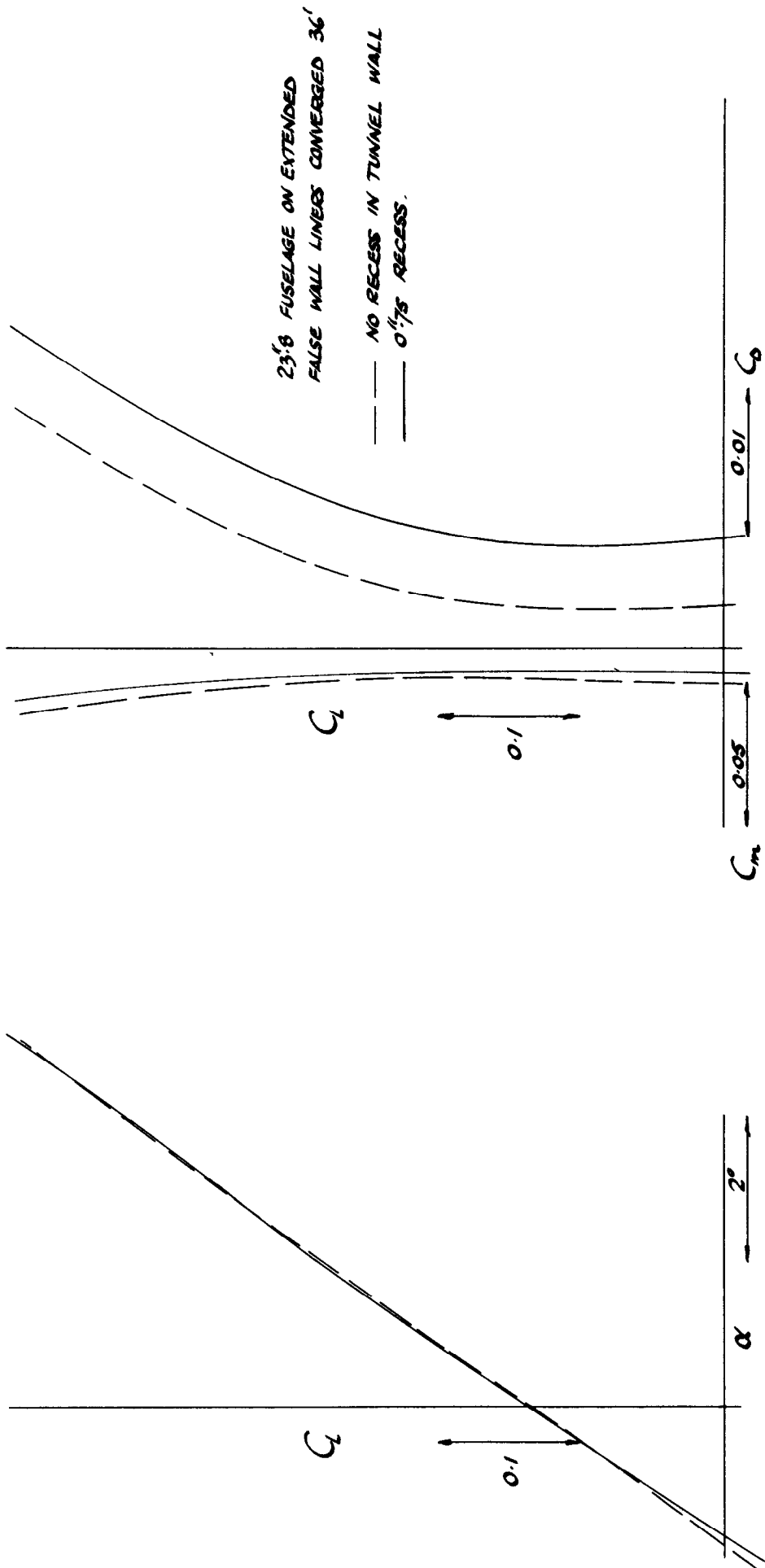

EFFECT OF REDUCING THE BOUNDARY LAYER THICKNESS
ON THE FALSE WALL AT LOW MACH NUMBER

<u>FUSELAGE</u>	<u>FALSE WALL</u>	<u>x</u>	
20"8	ORIGINAL	0"625	-----
20"8	EXTENDED	4"425	-----
23"8	EXTENDED	1"425	-----

x = DISTANCE BETWEEN THE FUSELAGE AND THE FALSE WALL LEADING EDGE

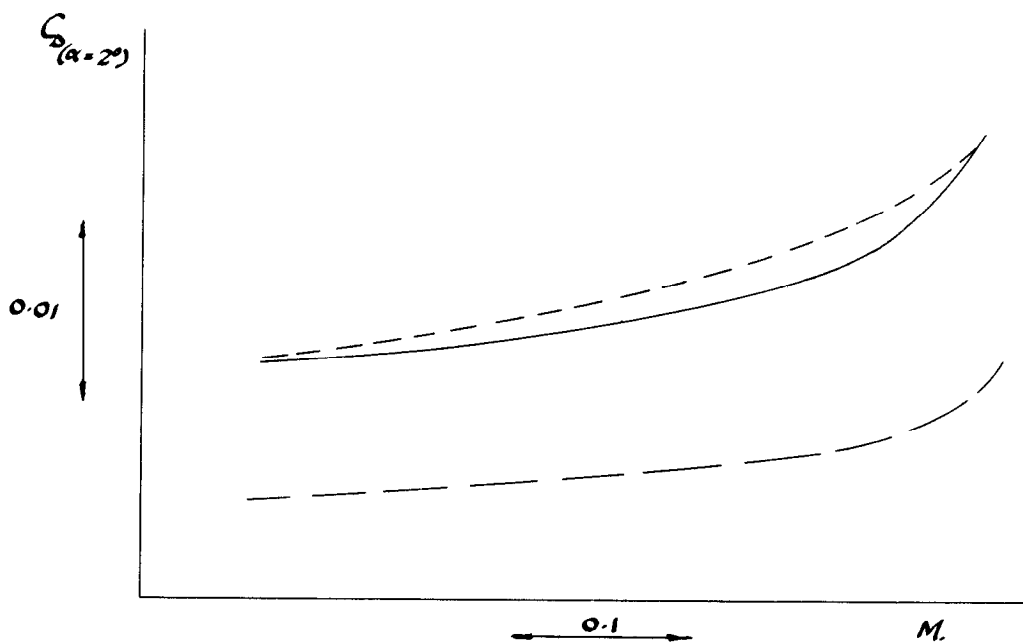

EFFECT OF RELATIVE FUSELAGE AND FALSE WALL DIMENSIONS
- ORIGINAL TUNNEL AND FALSE WALL ARRANGEMENT.

FIG 13 b.

23"8 FUSELAGE ON EXTENDED FALSE WALL LINERS
 CONVERGED 36'

NO RECESS IN TUNNEL WALL -----
 0"75 RECESS - - - - -

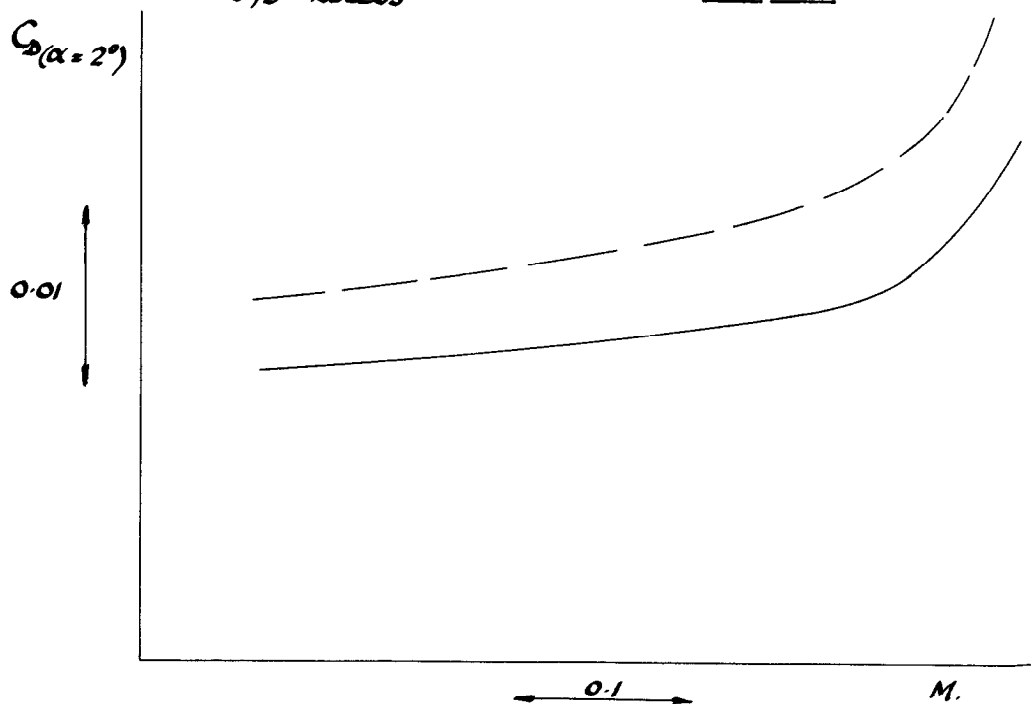

EFFECT OF REDUCING THE BOUNDARY-LAYER THICKNESS
ON THE FALSE WALL

C_D vs. MACH No.

23¹/₈ FUSELAGE ON EXTENDED FALSE WALL

ORIGINAL TUNNEL AND FALSE WALL ARRANGEMENT ———
 FINAL TUNNEL AND FALSE WALL ARRANGEMENT - - - - -

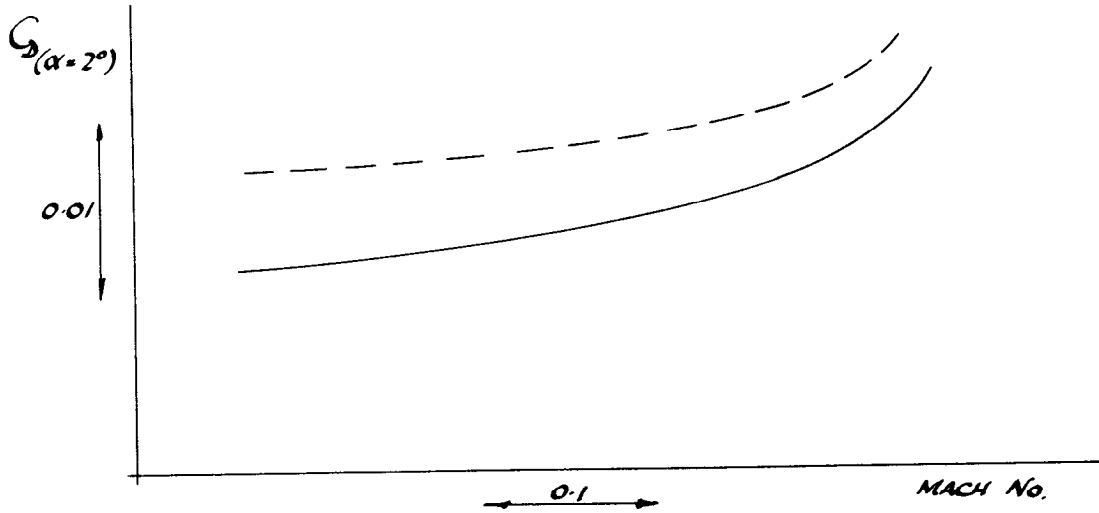

TOTAL EFFECT OF MODIFICATIONS TO THE TUNNEL AND FALSE WALL ARRANGEMENT

FIG 13d.

23¹/₈ FUSELAGE ON EXTENDED FALSE WALL
 LINERS CONVERGED 20'

0¹/₁₀₀ GAP ———
 0¹/₂₅₀ GAP - - - - -
 0¹/₆₂₅ GAP - - - - -

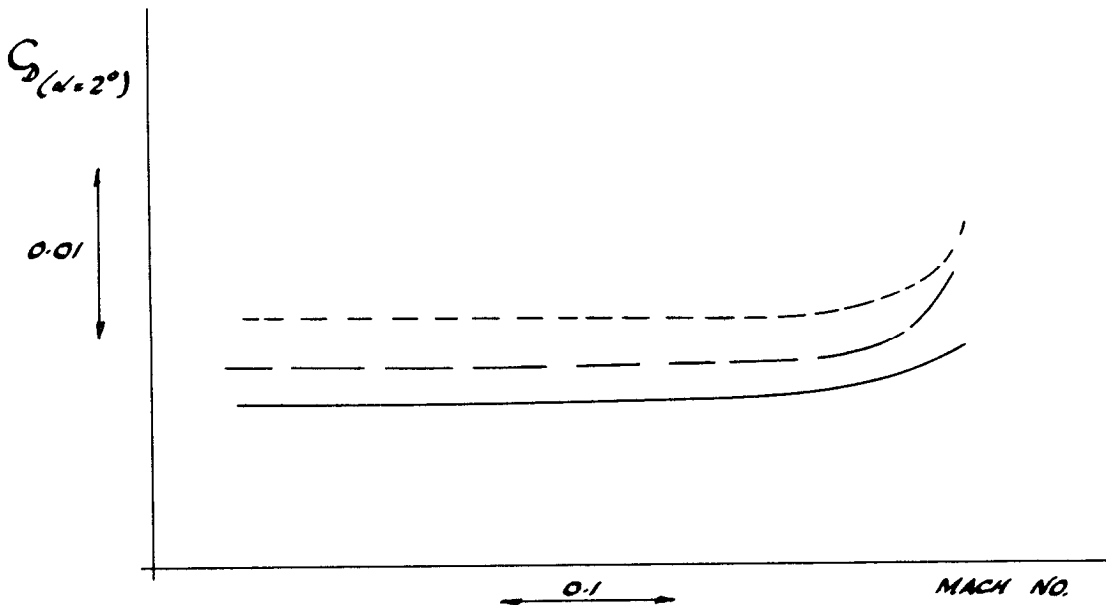

EFFECT OF GAP BETWEEN HALF-MODEL FUSELAGE AND FALSE WALL

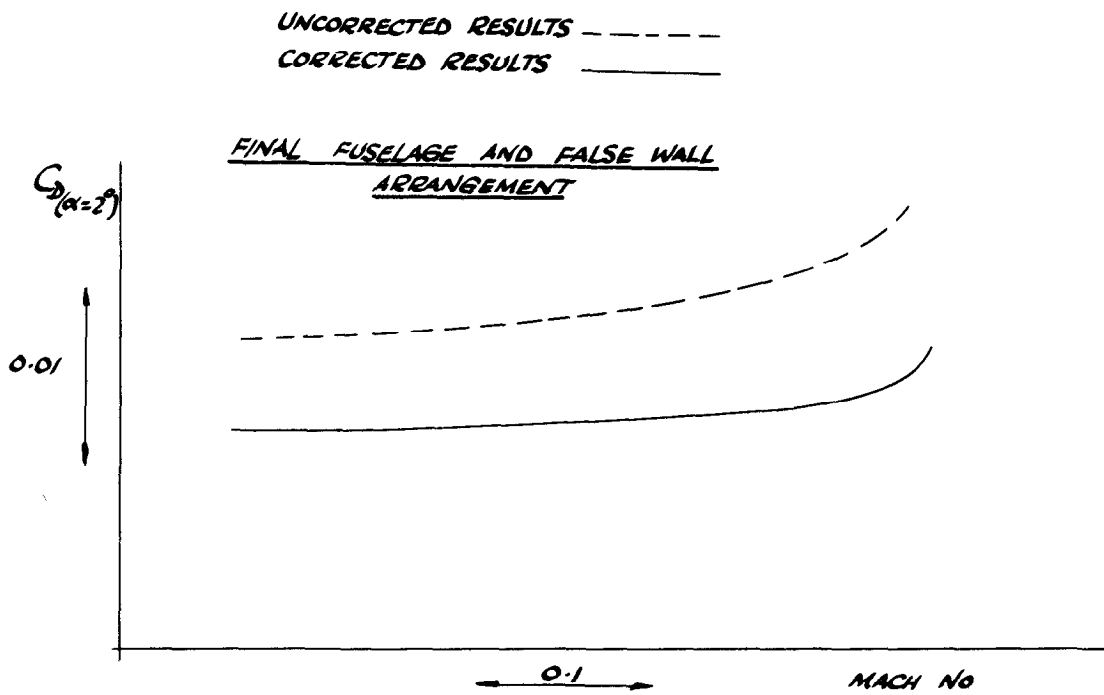

TOTAL EFFECT OF CORRECTIONS

A.R.C. C.P.587. August, 1961
Holder, D. R. and Farley, H. C.

PROBLEMS ASSOCIATED WITH THE USE OF A FALSE WALL AS A
REFLECTION PLANE FOR HALF MODEL TESTS IN THE
DE HAVILLAND HIGH SPEED WIND TUNNEL

The half model technique has been used extensively in the de Havilland High Speed Wind Tunnel. The false wall, as originally fitted, had a thick boundary layer, and caused disturbances in the freestream static pressure distribution. This report deals with the results of tests which led to an improved false wall arrangement, and to modifications of the transonic liner configuration.

The results of investigations over a period of fifteen months should, in many cases, be applicable to tests in other tunnels.

A.R.C. C.P.587. August, 1961.
Holder, D. R. and Farley, H. C.

PROBLEMS ASSOCIATED WITH THE USE OF A FALSE WALL AS A
REFLECTION PLANE FOR HALF MODEL TESTS IN THE
DE HAVILLAND HIGH SPEED WIND TUNNEL

The half model technique has been used extensively in the de Havilland High Speed Wind Tunnel. The false wall, as originally fitted, had a thick boundary layer, and caused disturbances in the freestream static pressure distribution. This report deals with the results of tests which led to an improved false wall arrangement, and to modifications of the transonic liner configuration.

The results of investigations over a period of fifteen months should, in many cases, be applicable to tests in other tunnels.

A.R.C. C.P.587. August, 1961.
Holder, D. R. and Farley, H. C.

PROBLEMS ASSOCIATED WITH THE USE OF A FALSE WALL AS A
REFLECTION PLANE FOR HALF MODEL TESTS IN THE
DE HAVILLAND HIGH SPEED WIND TUNNEL

The half model technique has been used extensively in the de Havilland High Speed Wind Tunnel. The false wall, as originally fitted, had a thick boundary layer, and caused disturbances in the freestream static pressure distribution. This report deals with the results of tests which led to an improved false wall arrangement, and to modifications of the transonic liner configuration.

The results of investigations over a period of fifteen months should, in many cases, be applicable to tests in other tunnels.

© *Crown copyright* 1962

Printed and published by
HER MAJESTY'S STATIONERY OFFICE

To be purchased from
York House, Kingsway, London, w.c.2
423 Oxford Street, London w.1
13A Castle Street, Edinburgh 2
109 St. Mary Street, Cardiff
39 King Street, Manchester 2
50 Fairfax Street, Bristol 1
35 Smallbrook, Ringway, Birmingham 5
80 Chichester Street, Belfast 1
or through any bookseller

Printed in England