

C.P. No. 413  
(20,302)  
A.R.C. Technical Report

RAFT ESTN. 111  
C.P. No. 413

C.P. No. 413  
(20,302)  
A.R.C. Technical Report



MINISTRY OF SUPPLY

AERONAUTICAL RESEARCH COUNCIL

CURRENT PAPERS

Effects of some changes in  
Body Length and Nose Shape on the  
Aerodynamic Characteristics of Wing-Body  
Combinations at Supersonic Speeds

by

*S. Tomlin & A. Stanbrook*

LONDON: HER MAJESTY'S STATIONERY OFFICE

1958

PRICE 3s. 6d. NET



U.D.C. No. 533.6.011.5 : 533.691.18 : 533.695.6

Technical Note No. Aero.2542

February, 1958

ROYAL AIRCRAFT ESTABLISHMENT

EFFECTS OF SOME CHANGES IN BODY LENGTH AND NOSE SHAPE  
ON THE AERODYNAMIC CHARACTERISTICS OF WING-BODY COMBINATIONS  
AT SUPERSONIC SPEEDS

by

S. Tomlin and A. Stanbrook

---

SUMMARY

Three bodies have been tested alone and in combination with each of two wings, at Mach numbers of 1.42 and 1.61, to find the effect of body length and nose shape on the aerodynamic characteristics of the wing-body combinations. The increments in the forces and moment resulting from the addition of the wing to the body varied little with the different body shapes tested.

---

## LIST OF CONTENTS

	<u>Page</u>
1 INTRODUCTION	3
2 DETAILS OF THE TESTS	3
2.1 Description of the models	3
2.2 Range of the tests	3
2.3 Accuracy	3
3 PRESENTATION AND DISCUSSION OF THE RESULTS	3
4 CONCLUSIONS	4

## LIST OF ILLUSTRATIONS

	<u>Fig.</u>
Delta and Swept Wing Models	1
The variation of $C_L$ , $C_D$ , and $C_m$ , for the bodies alone at $M = 1.42$	2a
The variation of $C_L$ , $C_D$ , and $C_m$ , for the bodies alone at $M = 1.61$	2b
The variation of $C_L$ , $C_D$ , and $C_m$ , for the delta wing-body combination at $M = 1.42$	2c
The variation of $C_L$ , $C_D$ , and $C_m$ , for the delta wing-body combination at $M = 1.61$	2d
The variation of $C_L$ , $C_D$ , and $C_m$ , for the swept wing-body combination at $M = 1.42$	2e
The variation of $C_L$ , $C_D$ , and $C_m$ , for the swept wing-body combination at $M = 1.61$	2f
The effect of body length and nose shape on the increments in $C_L$ , $C_D$ , and $C_m$ , resulting from the addition of the delta wing to the various bodies.	3a
The effect of body length and nose shape on the increments in $C_L$ , $C_D$ , and $C_m$ , resulting from the addition of the swept wing to the various bodies	3b

## 1 INTRODUCTION

A research programme is in progress in the R.A.E., Bedford 3 ft transonic and supersonic tunnel to study the aerodynamic characteristics of various wing shapes. As a preliminary step in the supersonic part of this programme tests were made to determine the effect of nose shape and body length on the aerodynamic characteristics of wing-body combinations. These tests, and the result obtained, are described in this note.

## 2 DETAILS OF THE TESTS

### 2.1 Description of the models

The models used are shown in Fig.1. The delta wing had a leading edge sweep of  $54.7^\circ$  and an aspect ratio of 2.83. The swept wing was of the same aspect ratio with a leading edge sweep of  $60.5^\circ$  and a taper ratio of  $1/3$ . The chordwise wing section of both models was R.A.E.101 of 6% thickness. In each case the wing was tested in combination with a cylindrical body having either a conical or a slightly blunted ogival nose. The conical nose was of  $15^\circ$  apex semi-angle and the ogive was 3.6 diameters long. Some tests were made with the ogival nosed configurations with a reduced body length downstream of the wing. There were therefore three combinations of nose and body with which each wing was tested:-

- (a) Ogival nose and short body.
- (b) Ogival nose and long body.
- (c) Conical nose and long body.

Additional tests were made on each of the corresponding bodies alone.

### 2.2 Range of the tests

Measurements were taken at Mach number of 1.42 and 1.61 at a constant Reynolds number of  $2.00 \times 10^6$  (based on the aerodynamic mean chord). Transition of the boundary layer from a laminar to a turbulent state was not fixed in any of the tests. An incidence range of  $\pm 8^\circ$  was covered at  $M = 1.61$  but at  $M = 1.42$  the incidence range was restricted by shock reflections from the top and bottom walls of the tunnel.

### 2.3 Accuracy

The estimated accuracy of the results is as follows:-

Lift coefficient, $C_L$	$\pm 0.005$
Drag coefficient, $C_D$	$\pm 0.001$
Pitching Moment coefficient, $C_m$	$\pm 0.001$
Incidence, $\alpha$	$\pm 0.1^\circ$

## 3 PRESENTATION AND DISCUSSION OF THE RESULT

The basic results on the bodies alone and on the various wing-body combinations are presented in Figs.2(a)-(f). The incremental values of  $C_L$ ,  $C_D$ , and  $C_m$ , obtained by subtracting the body-alone results (at the appropriate true incidence) from the results obtained on the wing-body combinations, are shown in Figs.3(a) and (b). Within the limits of

accuracy of the experimental measurements these figures show that the differences between the various cases are negligible except for one isolated result in Fig.3(a). Since this one isolated difference is not repeated at the corresponding negative incidence in the same figure it is probable that it is due to an incorrect reading.

In the main research programme the ogival nose has been used (except at  $M = 1.3$ ) since it is more suitable for testing at subsonic and transonic speeds. However, it is too long for use at  $M = 1.3$  since at this Mach number the reflection of the bow shock wave from the tunnel wall impinges on the rear body. Hence, it has been necessary to use the shorter, conical, nose at  $M = 1.3$ . The present results show that this change of nose will not affect the interpretation of the variation of the wing characteristics throughout the Mach number range.

#### 4 CONCLUSIONS

From the results of the tests presented here it is concluded that the changes of nose shape and body length involved had negligible effects on the aerodynamic characteristics when considered in the form (wing-body combination - body alone). In fact, the differences which occurred were less than the possible error in the experimental measurements.

---

DIMENSIONS ARE IN INCHES

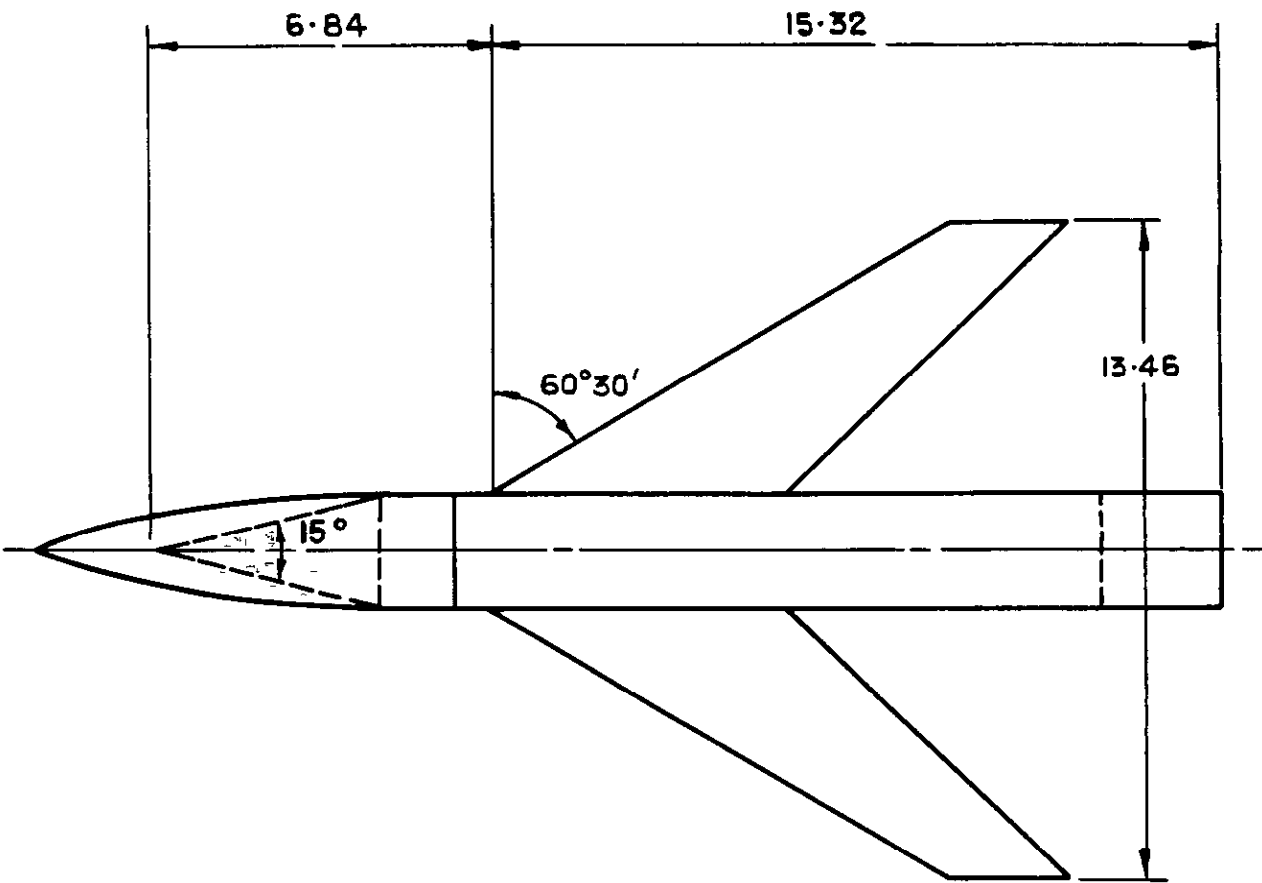
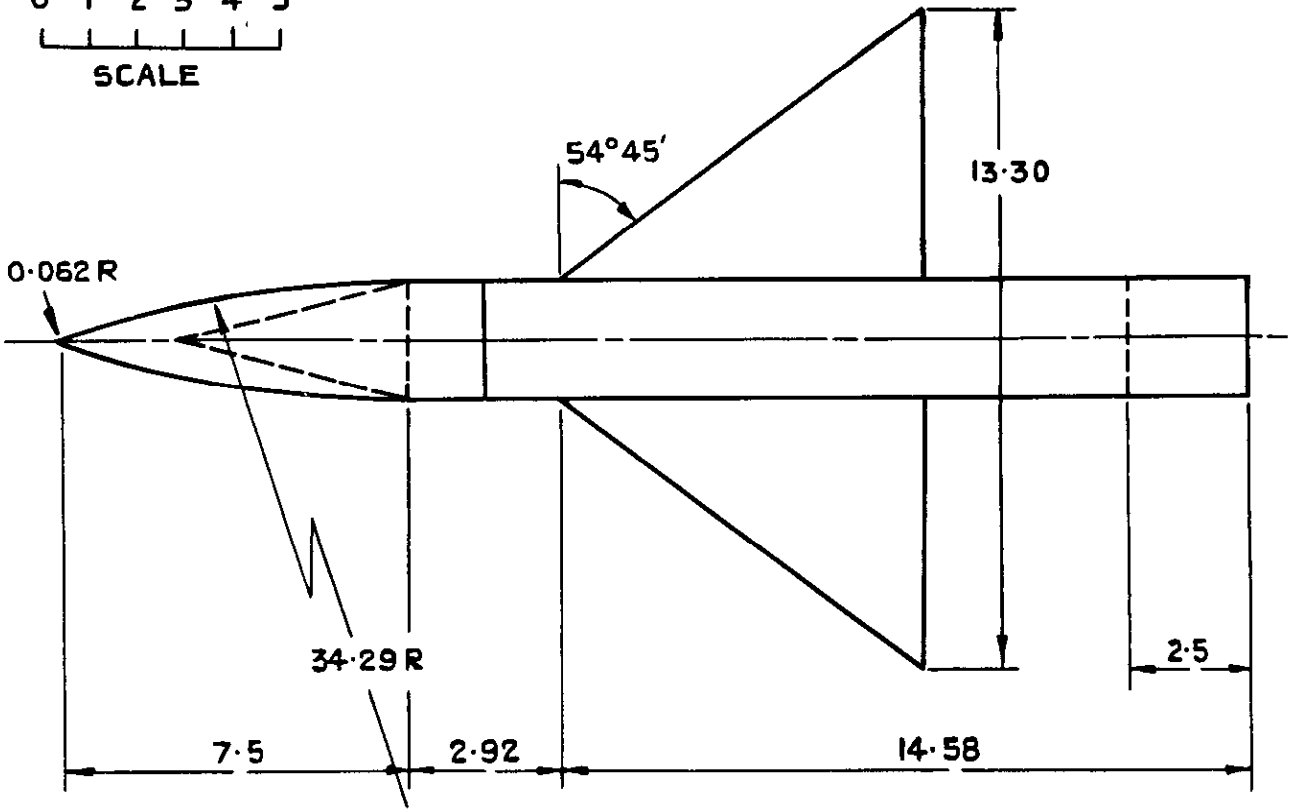
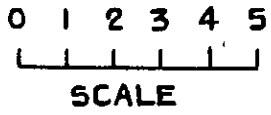

FIG. I. DELTA AND SWEEP WING MODELS.

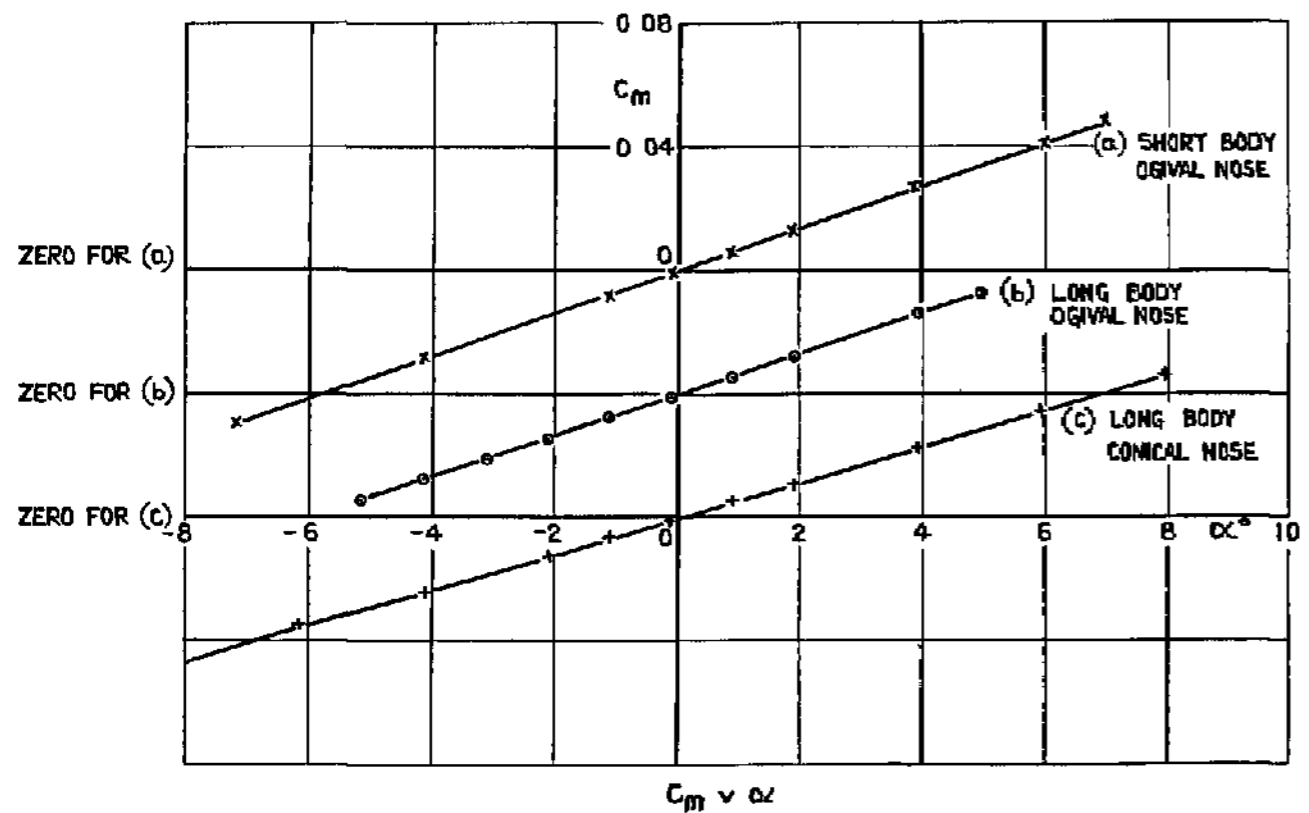
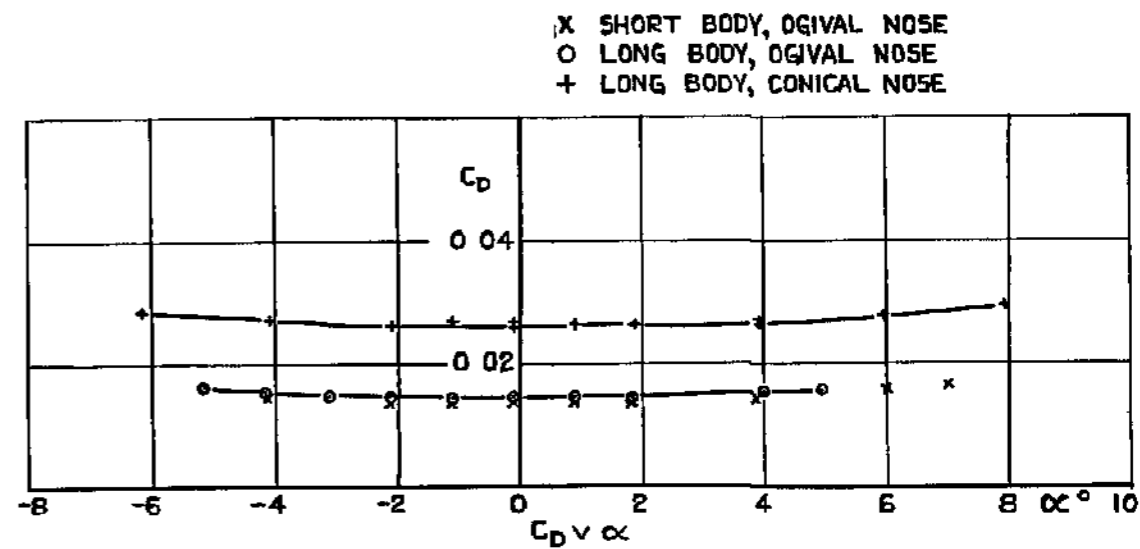
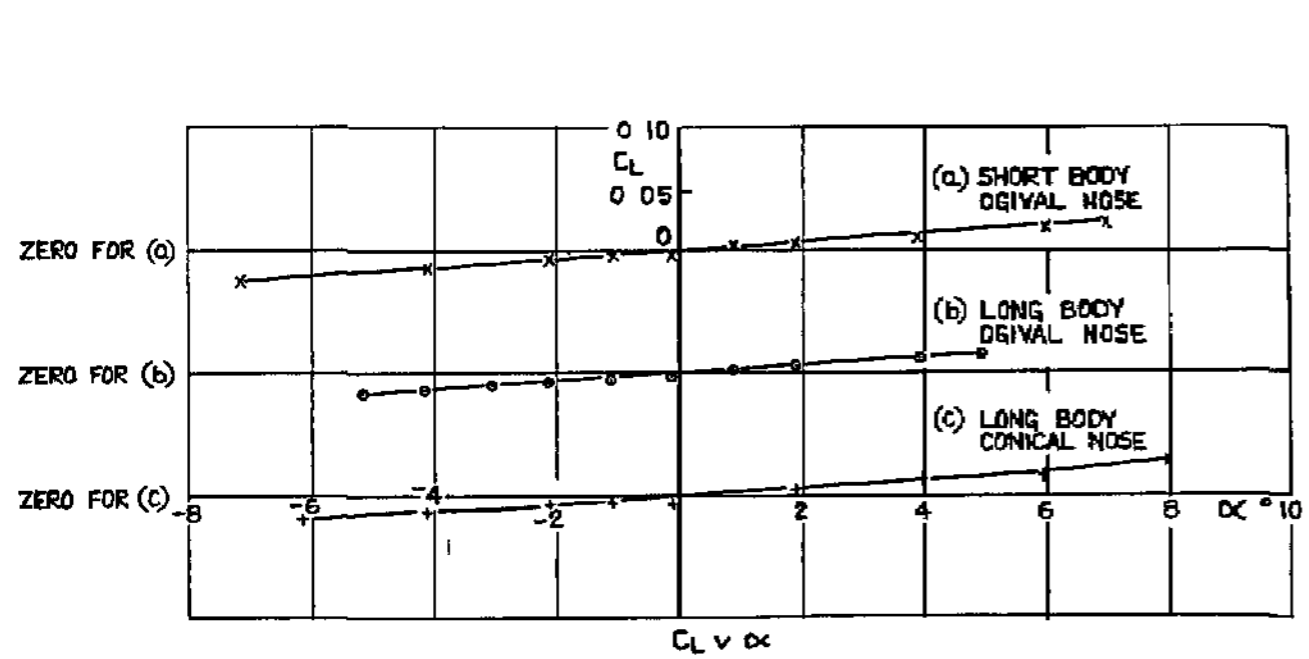

FIG 2 (a) THE VARIATION OF  $C_L$ ,  $C_D$  AND  $C_m$  FOR THE BODIES ALONE AT  $M=1.42$ .



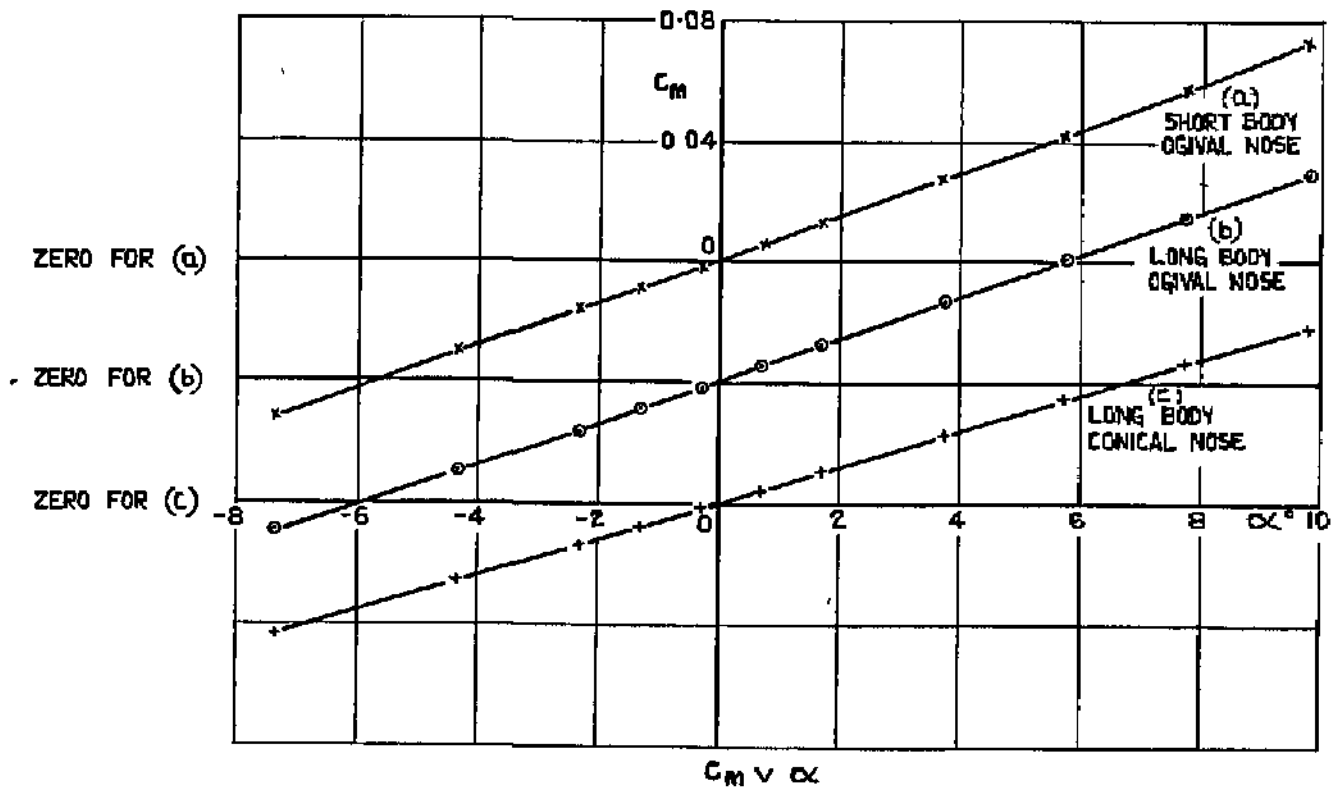
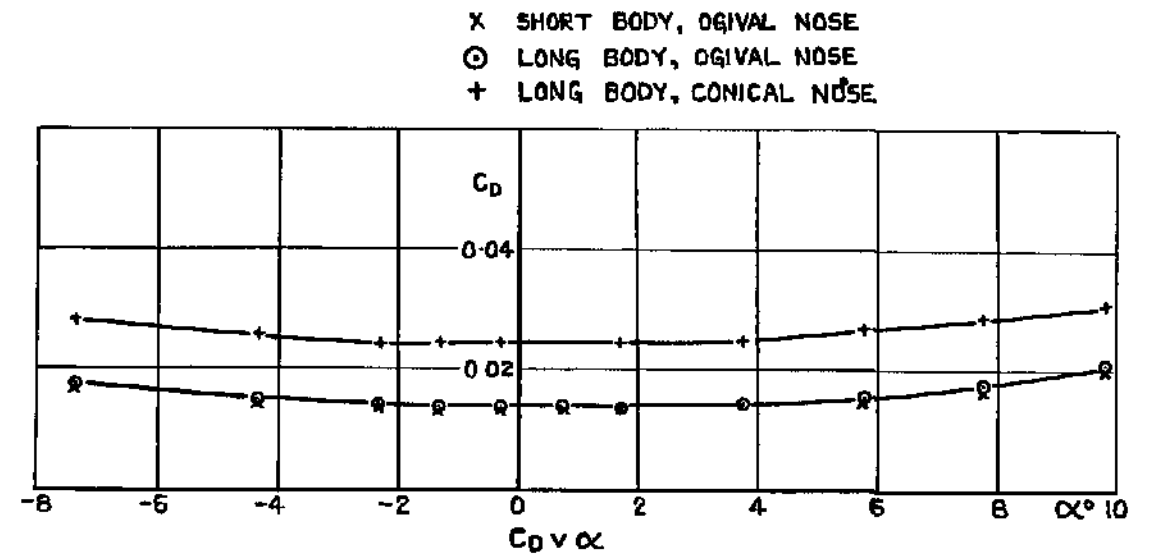
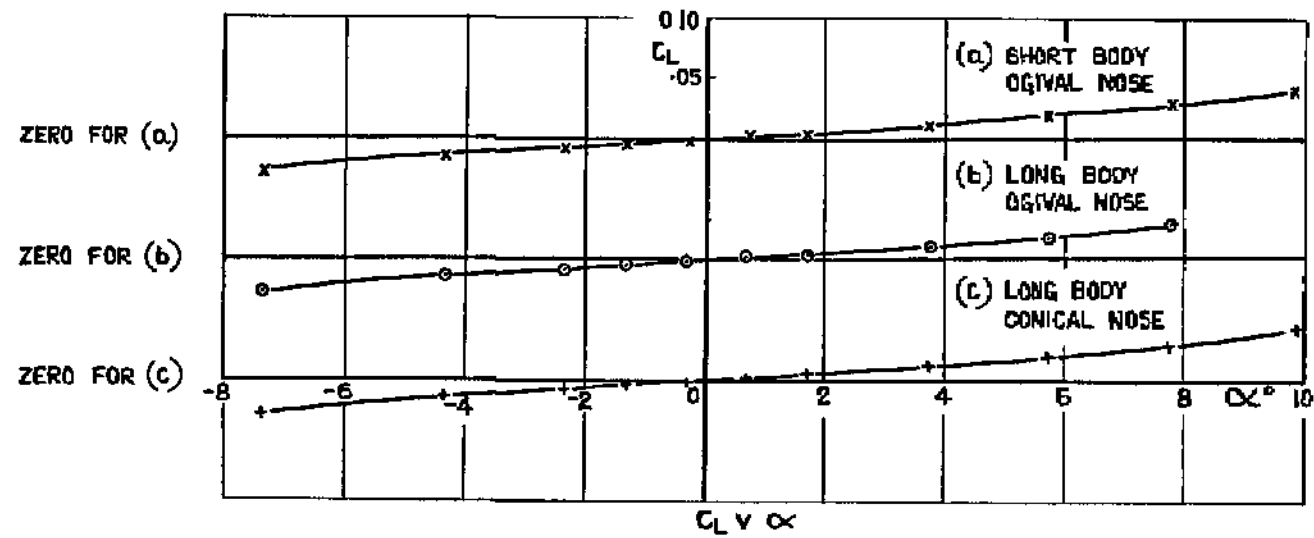
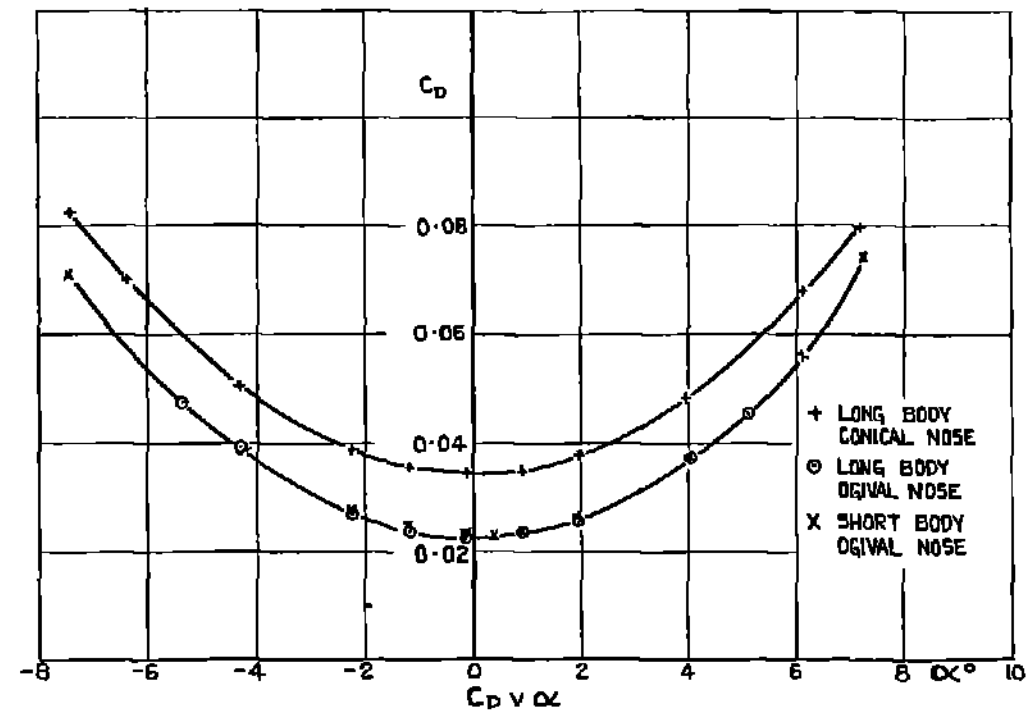
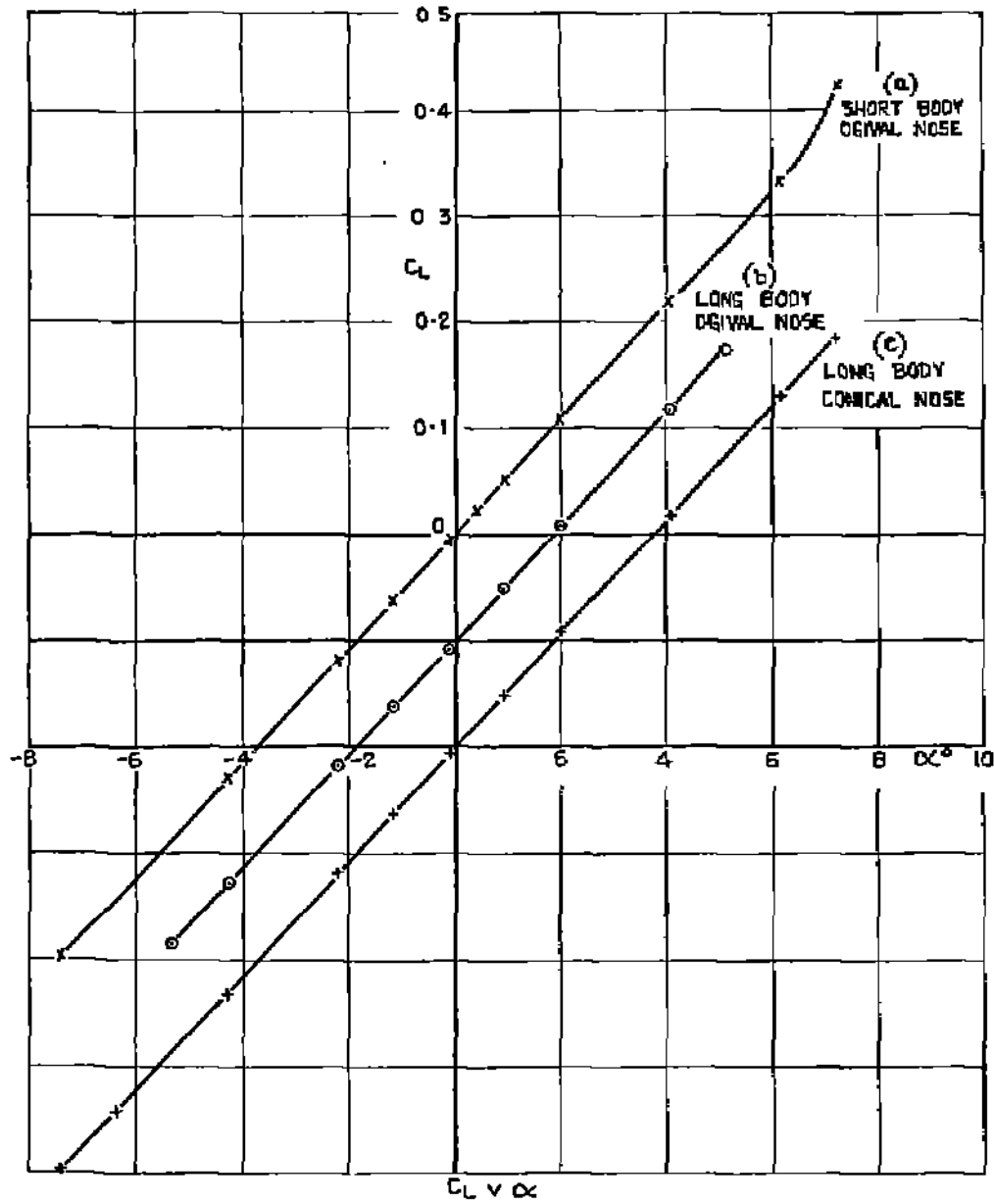

FIG. 2 (b) THE VARIATION OF  $C_L$ ,  $C_D$  AND  $C_m$  FOR THE BODIES ALONE AT  $M=1.61$ .

ZERO FOR (a)

ZERO FOR (b)

ZERO FOR (c)



ZERO FOR (a)

ZERO FOR (b)

ZERO FOR (c)

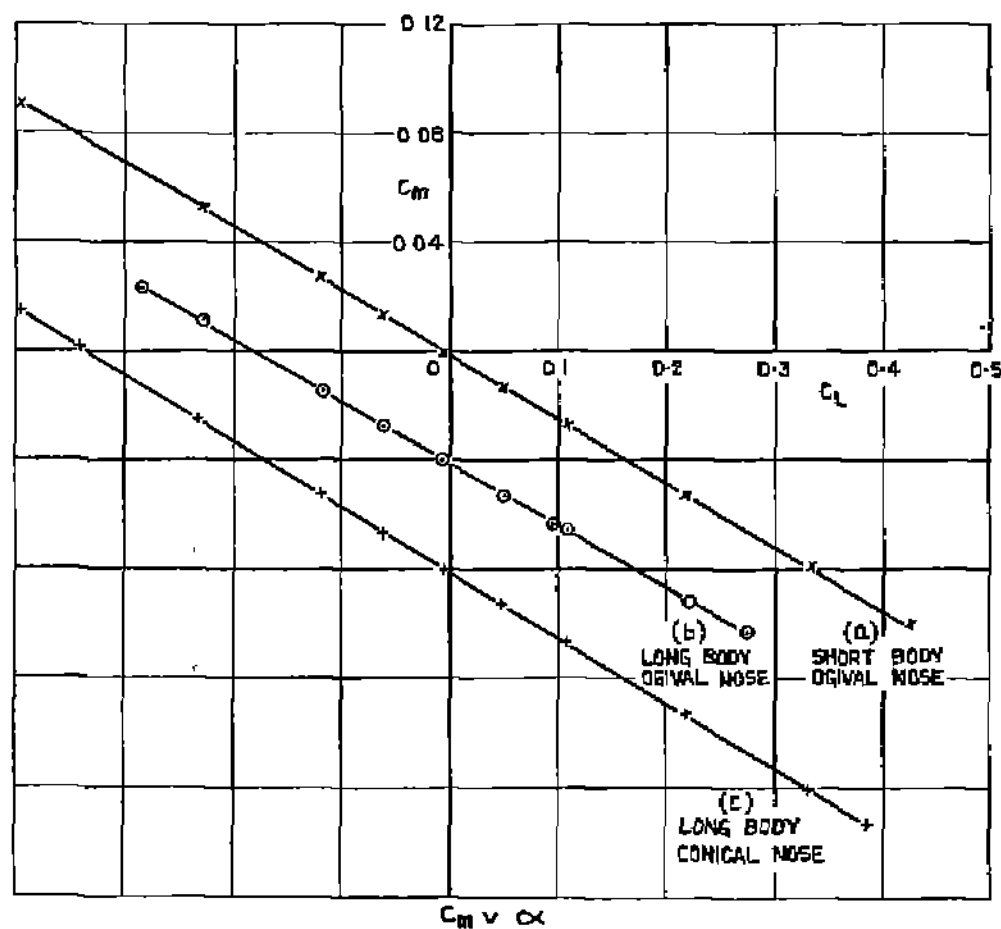

FIG. 2(c) THE VARIATION OF  $C_L$ ,  $C_D$  AND  $C_m$ , FOR THE DELTA-WING BODY COMBINATIONS AT  $M=1.42$ .

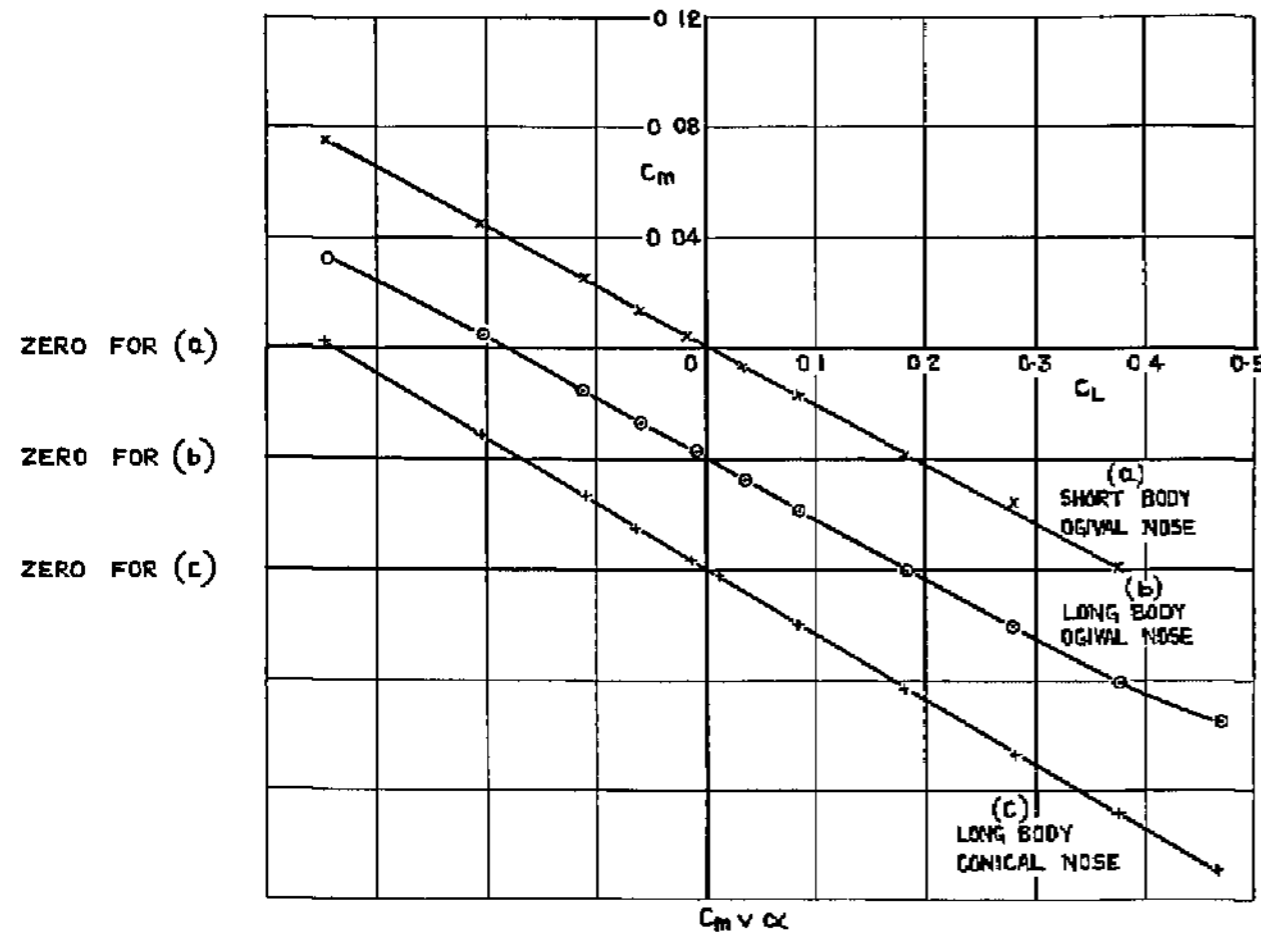
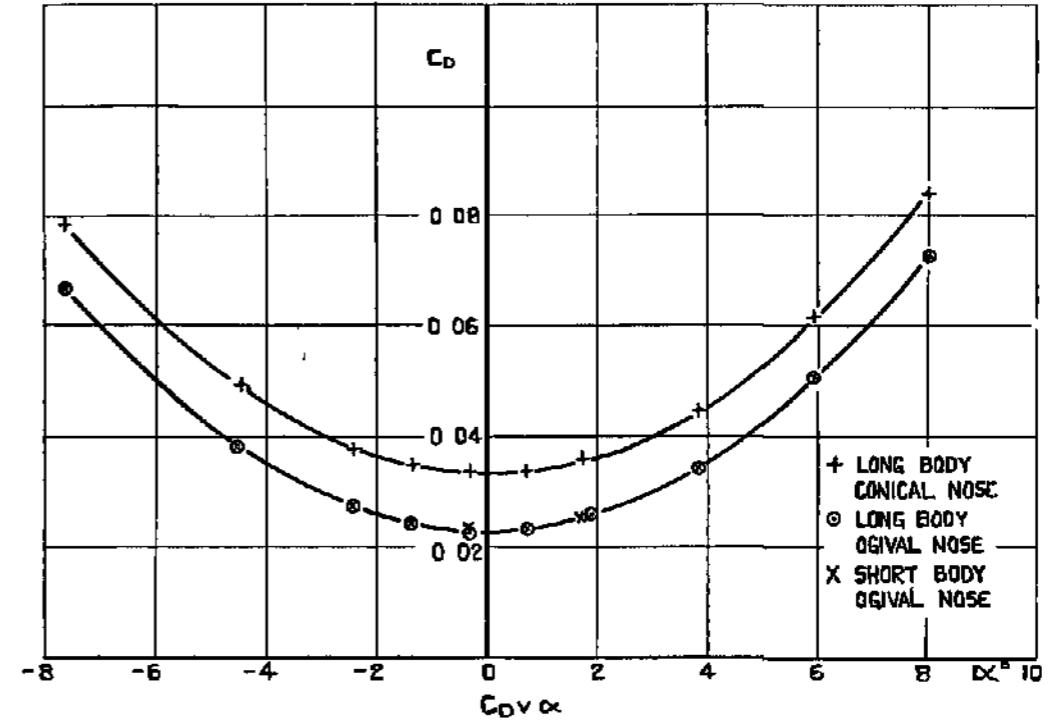
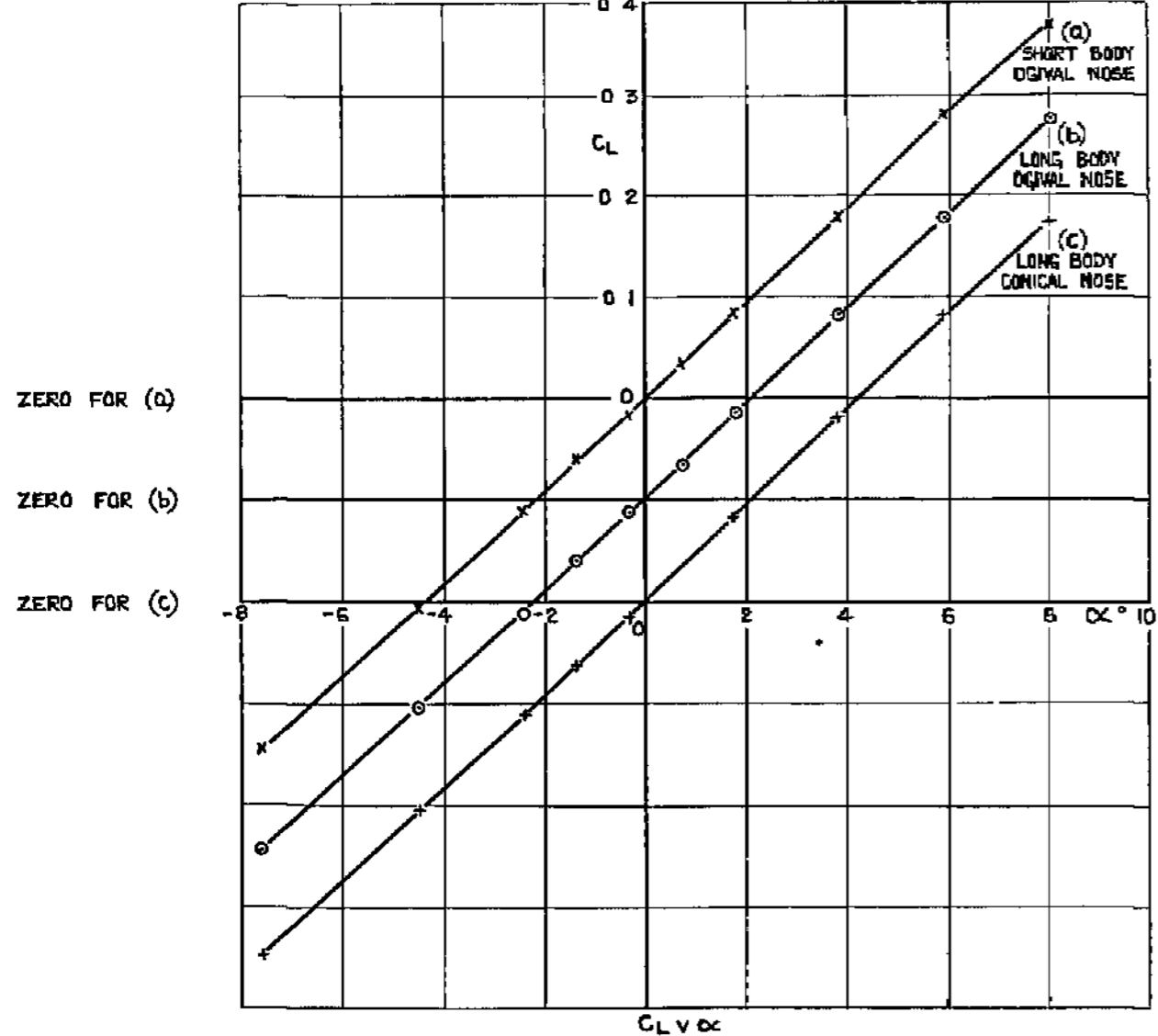

FIG. 2 (d) THE VARIATION OF  $C_L$ ,  $C_D$  AND  $C_m$  FOR THE DELTA-WING BODY COMBINATION AT  $M=1.61$ .

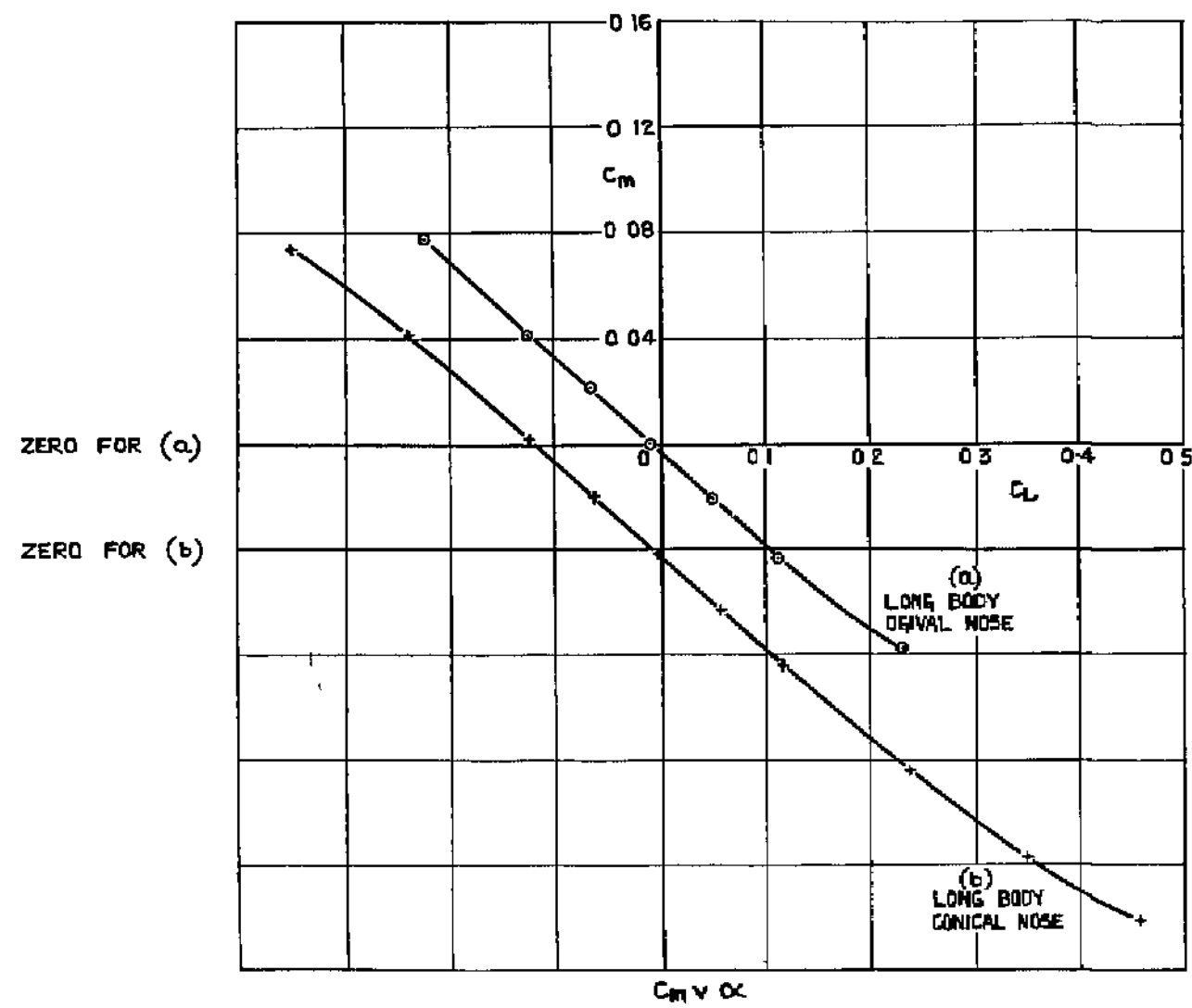
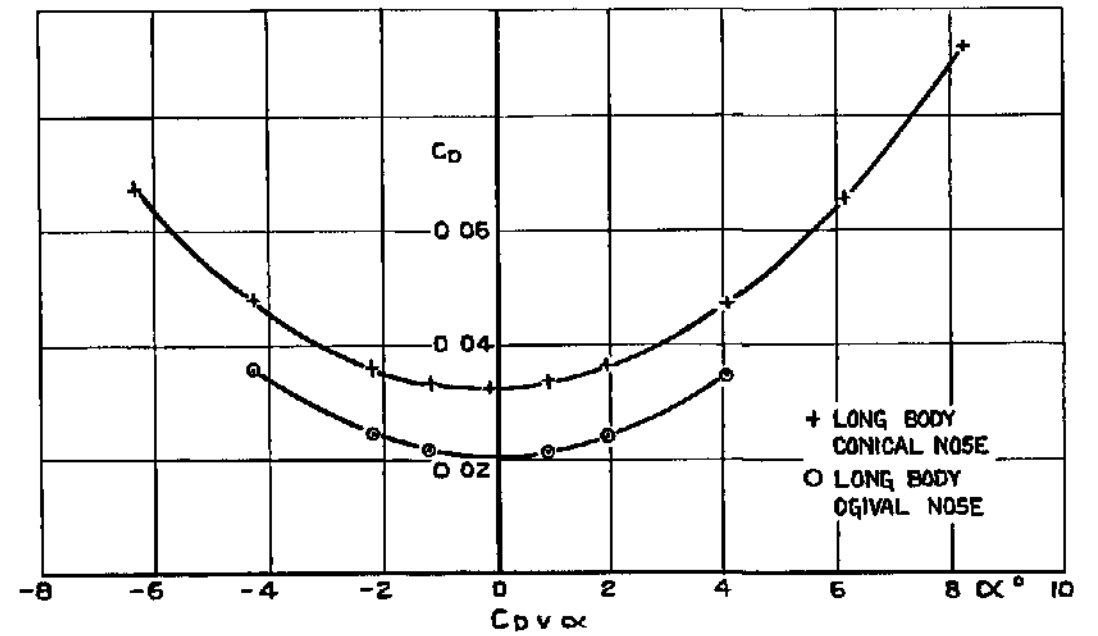
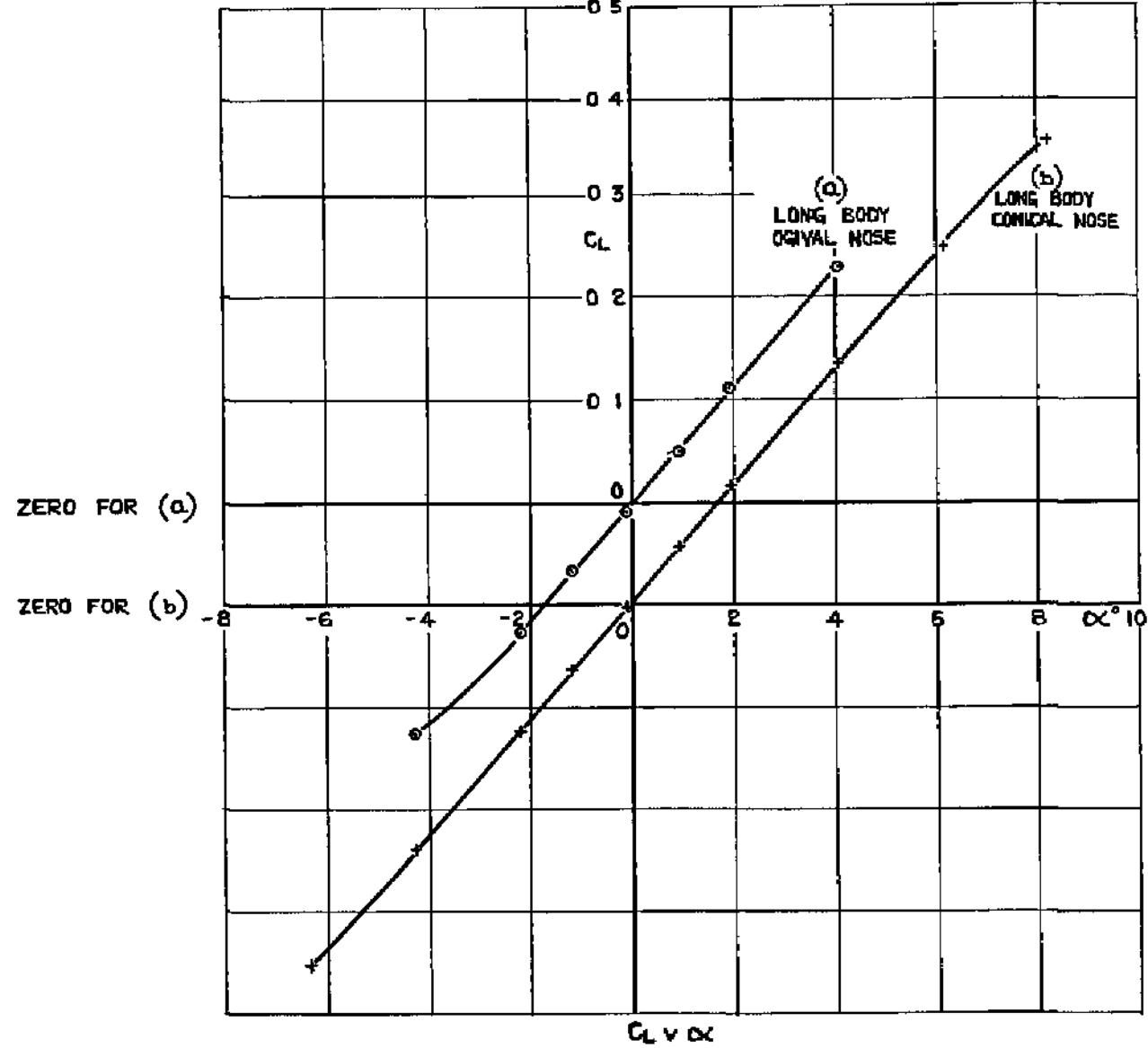

FIG. 2 (e) THE VARIATION OF  $C_L$ ,  $C_D$  AND  $C_m$  FOR THE SWEEP WING BODY COMBINATION AT  $M=1.42$ .

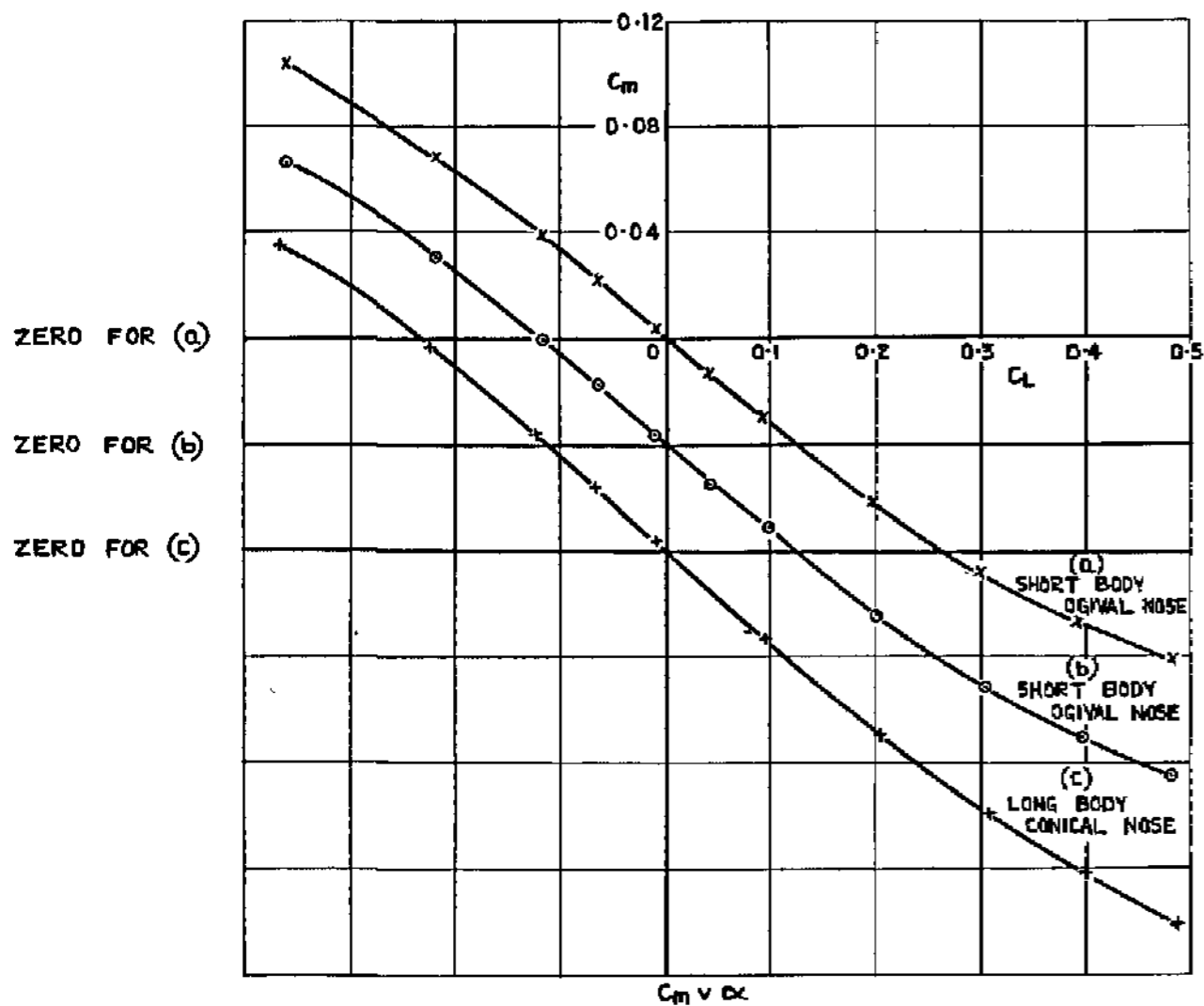
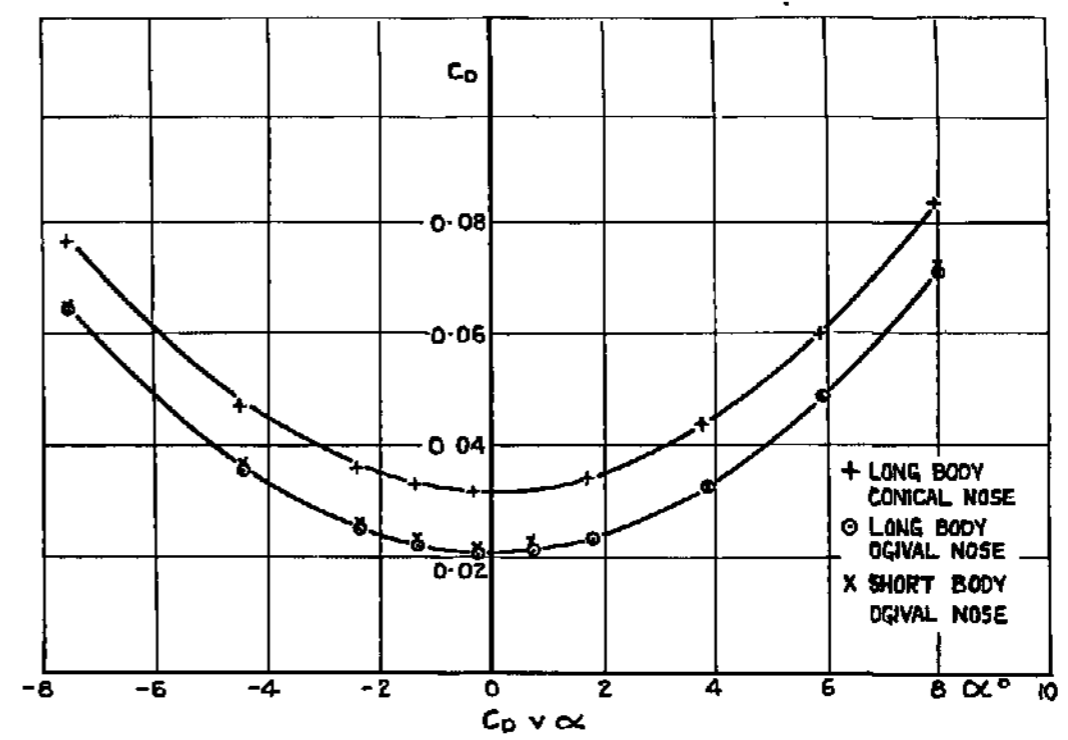
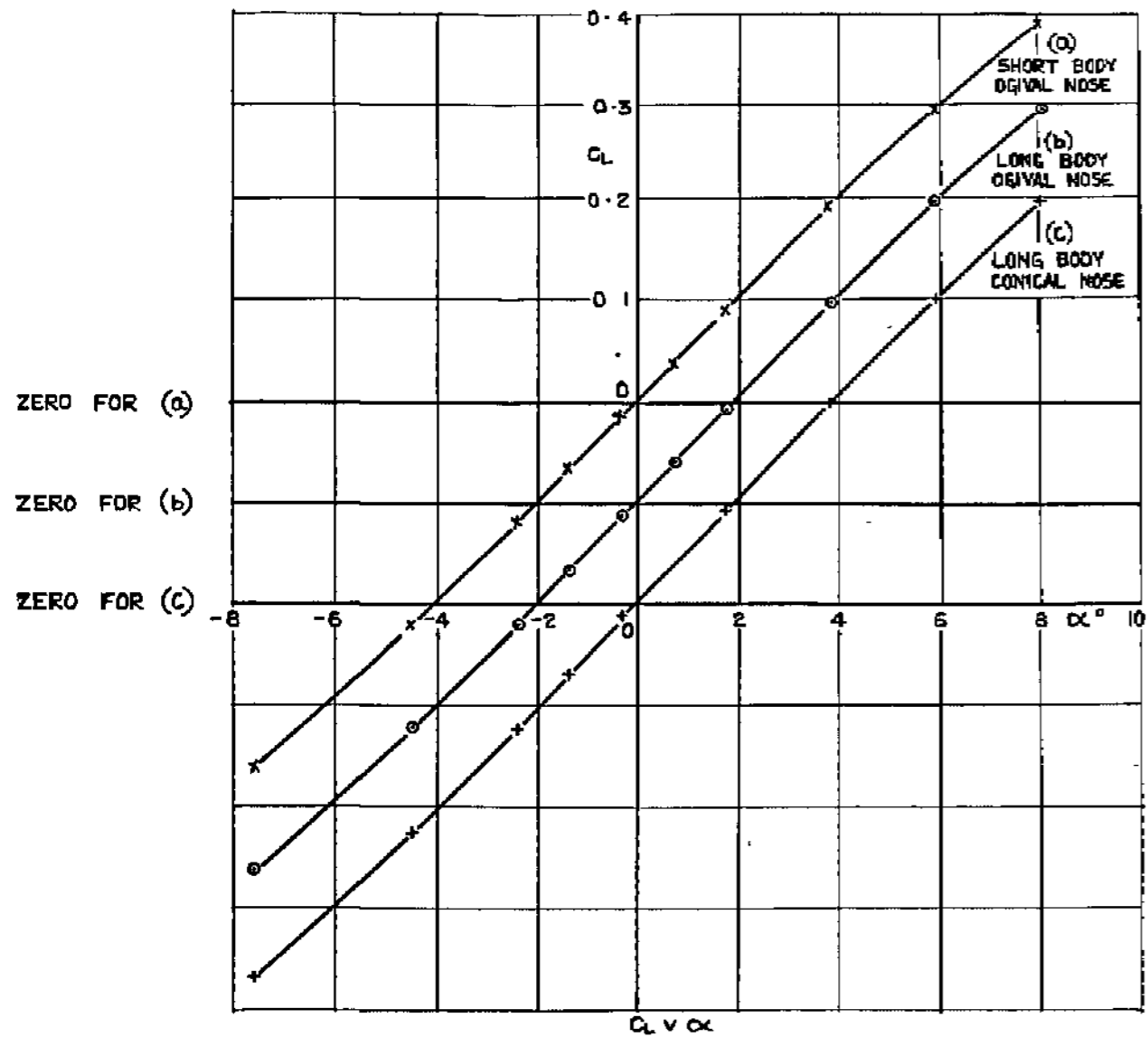

FIG.2(f) THE VARIATION OF  $C_L$ ,  $C_D$  AND  $C_m$  FOR THE SWEEP WING BODY COMBINATION AT  $M=1.61$ .

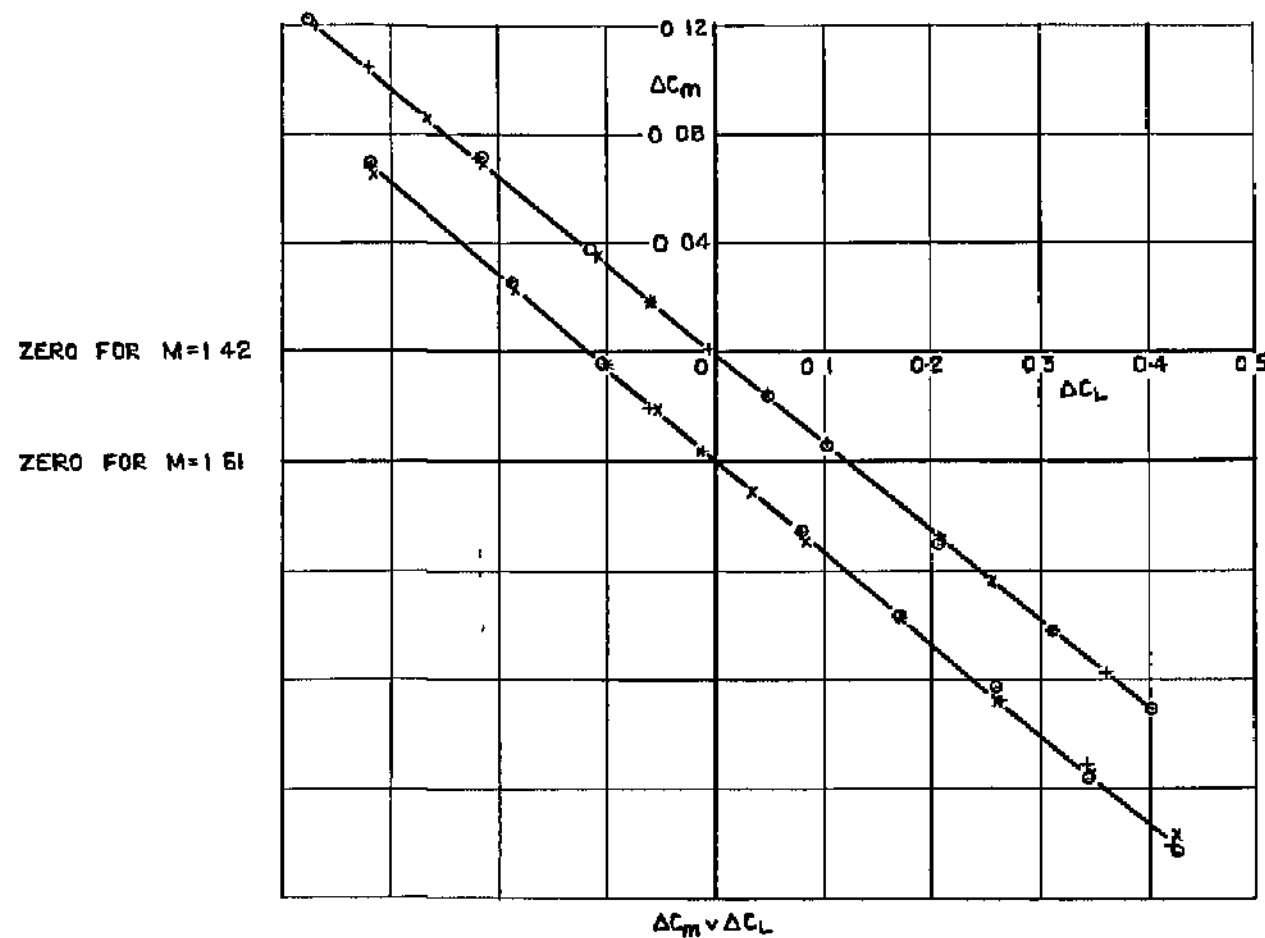
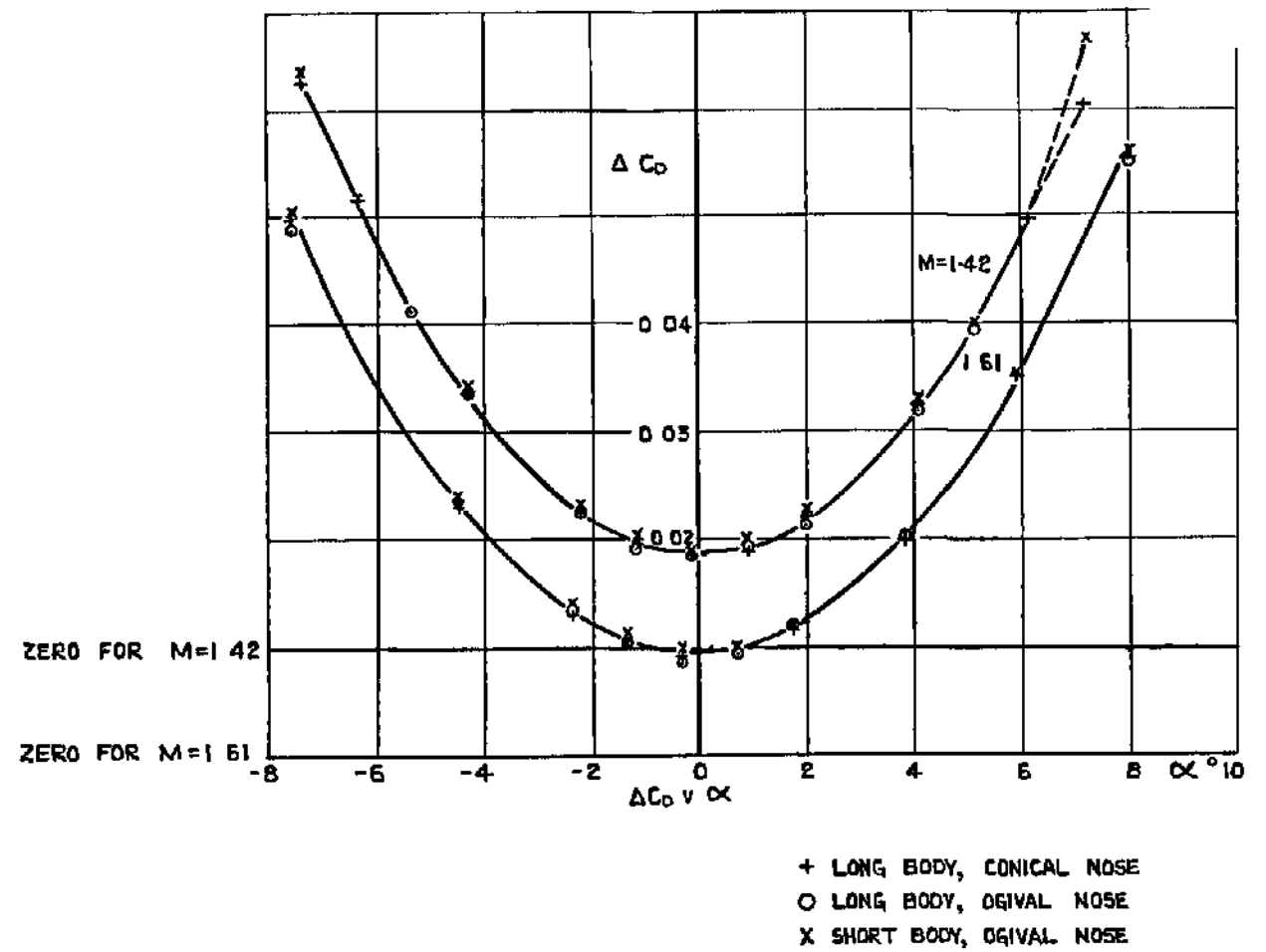
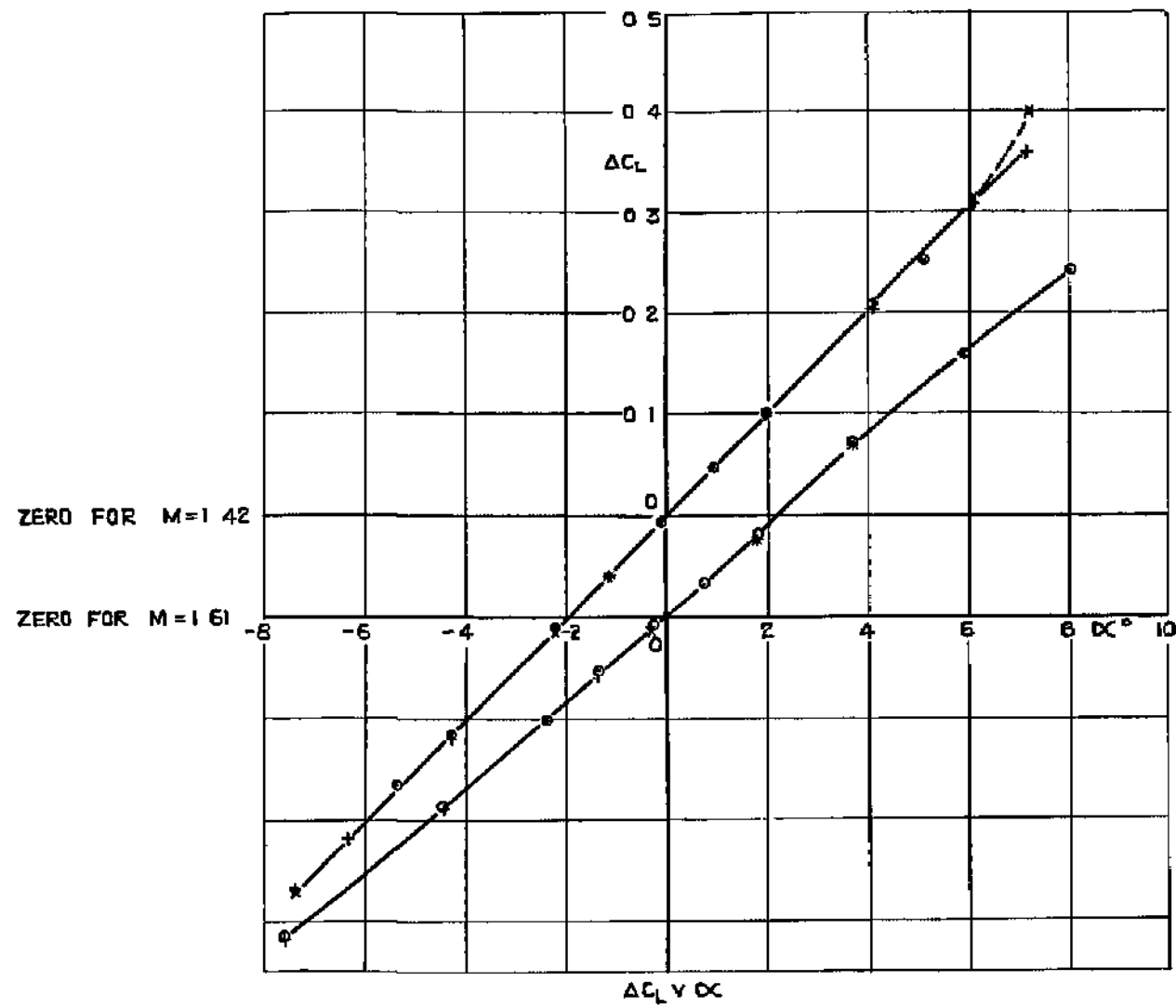

FIG. 3 (a) THE EFFECT OF BODY LENGTH AND NOSE SHAPE ON THE INCREMENTS IN  $C_L$ ,  $C_D$  AND  $C_m$  RESULTING FROM THE ADDITION OF THE DELTA WING TO THE VARIOUS BODIES.

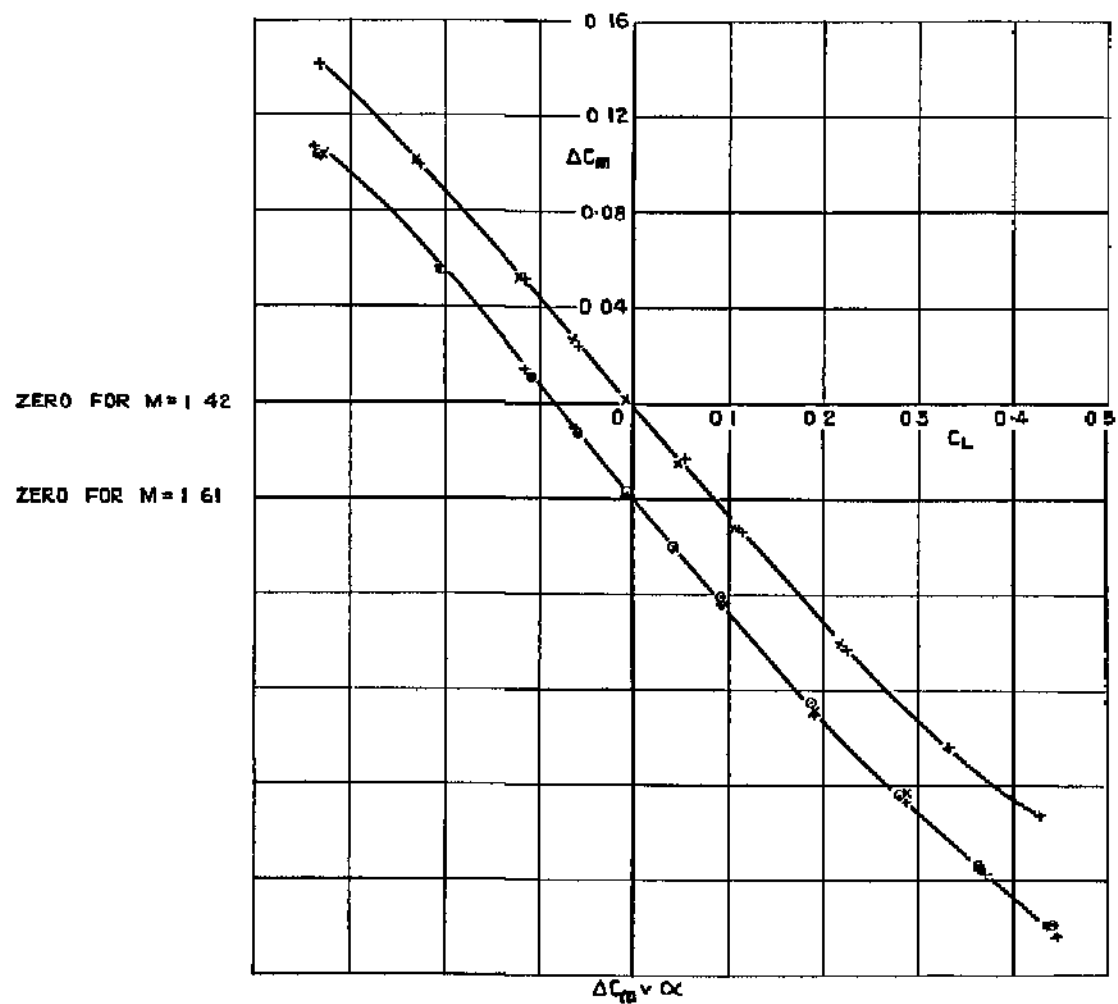
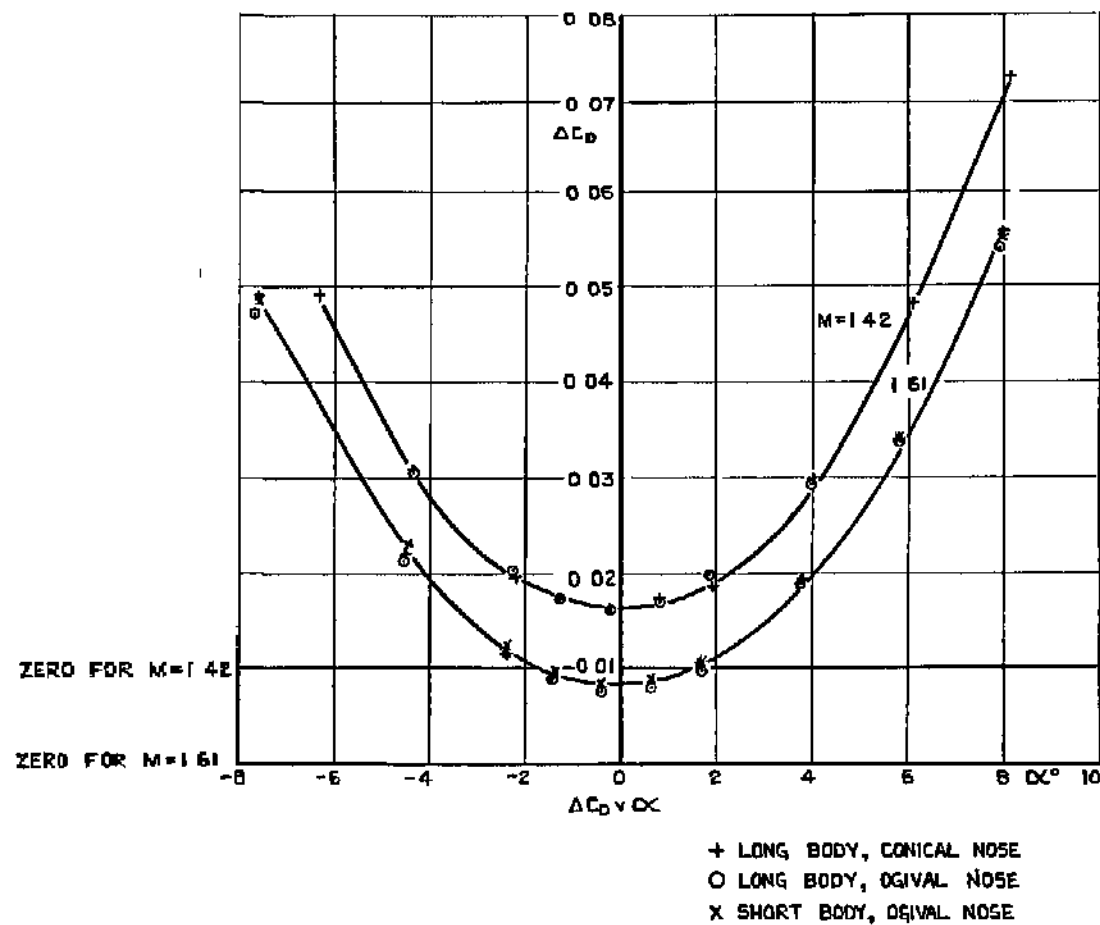
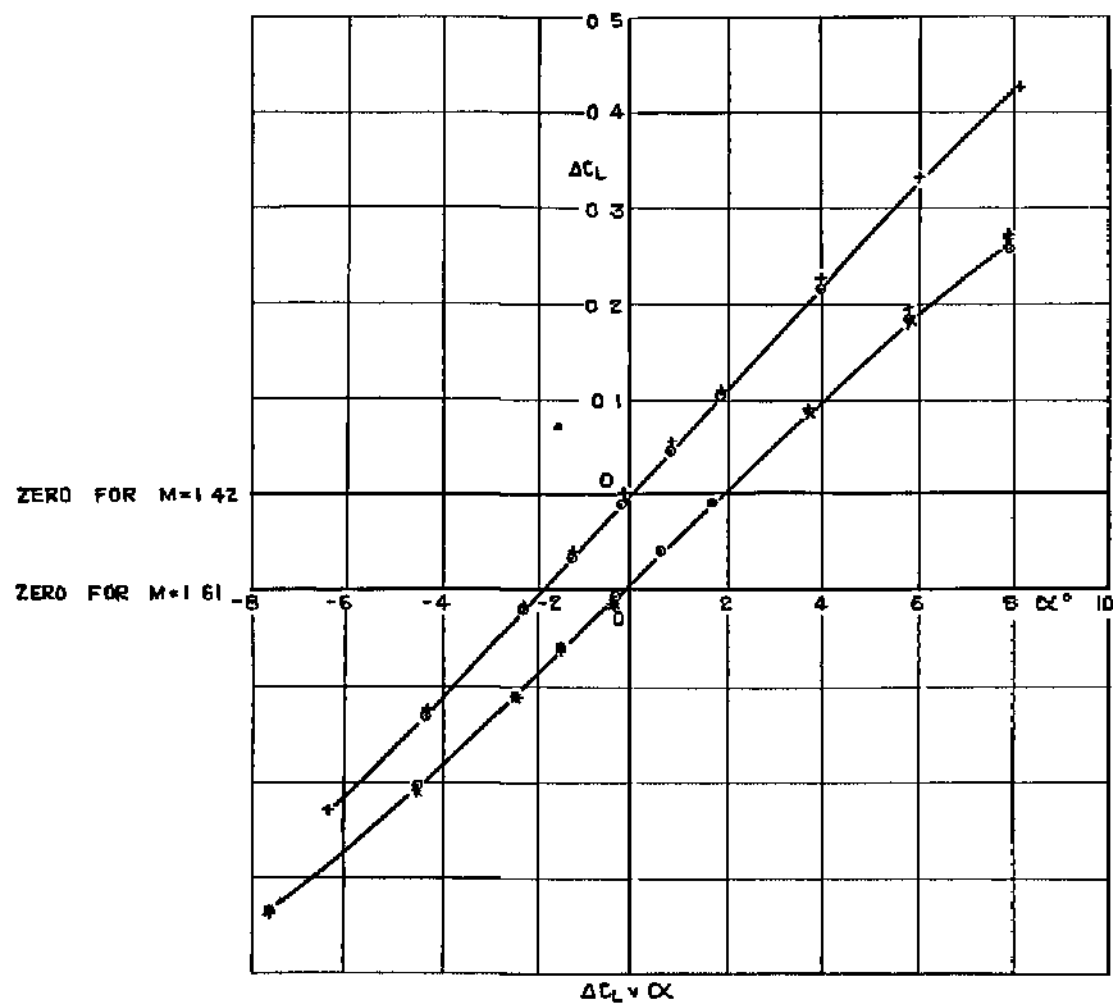

FIG. 3(b) THE EFFECT OF BODY LENGTH AND NOSE SHAPE ON THE INCREMENTS IN  $C_L$ ,  $C_D$  AND  $C_M$  RESULTING FROM THE ADDITION OF THE SWEEP WING TO THE VARIOUS BODIES.

+ LONG BODY, CONICAL NOSE  
 O LONG BODY, OGIVAL NOSE  
 X SHORT BODY, OGIVAL NOSE







© *Crown Copyright 1958*

Published by

**HER MAJESTY'S STATIONERY OFFICE**

To be purchased from

York House, Kingsway, London W.C. 2

423 Oxford Street, London W.1

13A Castle Street, Edinburgh 2

109 St. Mary Street, Cardiff

39 King Street, Manchester 2

Tower Lane, Bristol 1

2 Edmund Street, Birmingham 3

80 Chichester Street, Belfast

or through any bookseller

*Printed in Great Britain*