

RESEARCH
AERONAUTICAL RESEARCH COUNCIL
BEDFORD.

R. & M. No. 2546
(9,172 10,106)
A.R.C. Technical Report



MINISTRY OF SUPPLY

AERONAUTICAL RESEARCH COUNCIL
REPORTS AND MEMORANDA

Flight Tests on Hurricane II, Z.3687
fitted with Special Wings of
'Low-drag' Design

By

R. H. PLASCOTT, B.Sc. (ENG.), D. J. HIGTON, A.M.I.MECH.E., A.F.R.AE.S.,
F. SMITH, M.A., A.F.R.AE.S. and A. R. BRAMWELL

Crown Copyright Reserved

LONDON: HER MAJESTY'S STATIONERY OFFICE

1952

PRICE 3s 6d NET

Flight Tests on Hurricane II, Z.3687 fitted with Special Wings of 'Low-drag' Design

By

R. H. PLASCOTT, B.Sc. (ENG.), D. J. HIGTON, A.M.I.MECH.E., A.F.R.AE.S.,
F. SMITH, M.A., A.F.R.AE.S. and A. R. BRAMWELL

COMMUNICATED BY THE PRINCIPAL DIRECTOR OF SCIENTIFIC RESEARCH (AIR),
MINISTRY OF SUPPLY

*Reports and Memoranda No. 2546**
September, 1946

Summary.—This report describes flight tests to investigate the profile-drag characteristics of a 'low-drag' section wing built by Armstrong Whitworth, Ltd., using a new type of construction of their own design. During the first series of tests, a section of the wing was pressure-plotted and the results showed that it should be possible to obtain laminar flow over a range of lift coefficient from 0.12 to 0.50. A few preliminary profile-drag measurements were also made and a fairly low profile-drag coefficient ($C_D = 0.0046$ to 0.0050) was recorded over a lift coefficient range of 0.20 to 0.40; there was, however, a rapid rise in the profile drag coefficient at lift coefficients less than 0.20, and investigation of the surface waviness showed that the failure to maintain laminar flow at higher speeds was probably due to the excessive waviness present, which amounted to a variation of about $\pm 2\frac{1}{2}$ thousandths of an inch from the mean deflection curve on a two-inch gauge length.

A further series of profile-drag measurements was made when the surface waviness had been reduced to ± 1 thousandth of an inch variation from the mean deflection curve on a two-inch gauge length. It was found that, provided no flies or other insects were picked up during the flight, the drag coefficient had been reduced to 0.0044 over a range of lift coefficient from 0.12 to 0.50. This corresponds to transition from 50 to 60 per cent. chord. With the reduced surface waviness, it was possible to maintain laminar flow up to Reynolds numbers of nearly twenty millions.

1. *Introduction.*—A new type of construction thought to be suitable for the maintenance of laminar flow on a wing of 'low-drag' section has been designed by Armstrong Whitworth, Ltd. In order to determine the characteristics of such a wing in flight, special wings of this construction have been fitted outboard of the wing joint at the undercarriage to a Hurricane II, Z.3687.

During the first series of tests, which covered pressure plotting and profile-drag measurements on a test section and were extended to include measurement of profile drag with transition fixed by surface ridges, it was found that the waviness of the surface was large enough to prevent full laminar flow being established, especially at the higher Reynolds numbers. The aircraft was, therefore, returned to Armstrong Whitworth, Ltd., for reduction of the surface waviness by use of an appropriate filler and careful rubbing down. The second series of tests was undertaken to determine the improvement obtained by reducing in this way the surface waviness to ± 1 thousandth of an inch variation from the mean deflection curve on a two-inch gauge length.

Aircraft performance has not been measured, since the relatively poor finish of the Hurricane fuselage and wing roots would tend to mask the improvement obtained with the low-drag wings.

* R.A.E. Reports Aero. 2153 and 2090, received 22nd November, 1946, and 21st November, 1945.

2. *Description of the Aircraft.*—The aircraft, of which a general arrangement drawing is given in Fig. 1, was fitted with a Merlin XX engine. The wings were designed and built by Armstrong Whitworth, Ltd., using a special method of construction of their own. There was no spar in the design, the stresses being taken in a thick skin (18 s.w.g.), stiffened by spanwise stringers of 3-inch spacing (Fig. 2). The top and bottom surfaces were connected by ribs 15 inches apart. The leading and trailing edges were constructed in a normal manner and were connected to the 'low-drag' construction, which extended from 5 to 62 per cent of the chord on both surfaces.

The wing section was designed by the National Physical Laboratory to give a peak suction at 50 per cent chord and the design lift coefficient was 0.3. The root thickness was 17.9 per cent and tip thickness 14.8 per cent chord. The junction of the low-drag wing and the 'conventional section' wing root was covered by a fairing panel to blend the different profiles into each other.

The test section was 9 feet from the aircraft centre-line on the port wing (Fig. 1). The details of the test section, together with its profile, are shown in Fig. 2.

An auto-observer was fitted in the aircraft fuselage, containing nineteen airspeed indicators used as pressure instruments, an accelerometer and an A.S.I. and altimeter for measuring aircraft speed and altitude.

3. *Description of the Tests.*—3.1. *Pressure Plotting.*—To investigate the pressure distribution over the test section, pressure plotting fittings were installed in the wing by the firm during manufacture. The type of fitting and the positions used are shown in Fig. 2. The local pressures were measured on the airspeed indicators in the auto-observer, relative to either aircraft static or pitot pressure according to the range of pressure likely to be encountered.

For subsequent tests measuring profile drag, the holes were covered with filler and rubbed down to conform to the local profile of the wing.

3.2. *Measurement of Profile Drag.*—The profile drag of the test section was measured by a pitot comb mounted 8.17 inches (9.94 per cent chord) behind the trailing edge (Figs. 1 and 2). The loss in total head in the wake was measured by connecting the tubes to the airspeed indicators previously used for the pressure-plotting tests. All the pressures were measured relative to the free-stream total-head pressure; the static pressure in the wake was also measured.

The profile drag of the section was calculated from the 'top hat' curves of the wake traverse by the method of Ref. 1.

3.3. *Flight Test Data.*—All the tests were made in level flight at 10,000 feet. In order to obtain the higher speeds, the aircraft had to be dived from some height above 10,000 feet and then levelled out before taking readings. This of course meant that the aircraft was decelerating whilst the readings were being taken; the deceleration, however, was only about 1 ft/sec² and the correction to drag coefficient due to this was negligible.

3.4. *Measurement of Surface Waviness.*—The surface waviness was measured by means of a deflection gauge, which consisted of an Ames dial mounted on an adjustable base. The method and its usefulness are discussed in greater detail in the report on the low-drag tests on the *King Cobra*². Traverses of the wing were made with a three-inch gauge length on the test section and on sections five inches and ten inches inboard and outboard of the test section. As the spacing of the spanwise stringers was also three inches, these measurements tended to exaggerate the waviness; for comparison with the flight tests on the *King Cobra*², a traverse of the test section was made with a two-inch gauge length.

3.5. *Use of Tapes to Fix Transition.*—During the first series of tests, an attempt was made to determine the variation of profile drag with transition point. This was done by sticking layers of adhesive tape 0.75 inch wide and 0.0036 inch thick to the top and bottom surfaces of the wing at a known position. The profile drag measured with various thicknesses of tape enabled the profile drag due to transition at the known position to be determined. As a check on the method, copper wire 0.018 inch in diameter was stuck to the surface with one layer of adhesive tape, so that the ridge so formed was equivalent to six layers of the adhesive tape.

4. *Results.*—4.1. *Pressure Plotting.*—The results of the pressure plotting tests are given in Figs. 3 to 5 and are in good agreement with the theoretical distributions calculated for the section by the N.P.L. It will be seen that the peak suction occurs at about 50 per cent—the design position—and that the design lift coefficient is about 0.30. The range of lift coefficient over which it should be possible to maintain laminar flow will be seen to be from 0.12 to 0.50, since outside this range the velocity gradient will be unfavourable on one surface.

4.2. *Profile Drag and Surface Waviness Measurements.*—The results of the surface waviness measurements on the aircraft when it first arrived from the firm are given in Figs. 6, 7 and 8. Fig. 6 shows the waviness on the test section as measured with a two-inch gauge length and Figs. 7 and 8 give the values for the test section and two other sections on each side of the test section with a three-inch gauge length. It will be seen that the deflection on a two-inch gauge length varies about ± 2 thousandths of an inch from the mean deflection curve and in two places on the top surface is appreciably more. A similar deflection variation on the *King Cobra*² did not give complete low-drag characteristics and it was found necessary to reduce the waviness to ± 1 thousandth of an inch deflection variation on a two-inch gauge length before full laminar flow was achieved.

The profile drag coefficients obtained on the test section in this condition and calculated by the method of Ref. 1 are shown plotted against lift coefficient in Fig. 9. The lowest coefficients recorded were about 0.0045 at $C_L = 0.2$, corresponding to a theoretical transition of about 54 per cent. The range of lift coefficient over which moderately low drag was obtained was only from 0.2 to 0.45, which is far less than that which might be expected from the pressure plotting tests. At lift coefficients of less than 0.2 the drag coefficient rises rapidly. A similar rise was experienced on the *King Cobra*² with this order of waviness at Reynolds numbers greater than 12 millions. Above this Reynolds number the surface waves will cause the transition to move progressively forward with Reynolds number.

It was concluded from these tests that excessive surface waviness was preventing the full gain from the low-drag section being obtained. The aircraft was, therefore, returned to the firm for reduction of the surface waviness. The results of surface waviness measurements made on the aircraft's return are given in Figs. 10, 11 and 12. It will be seen from Fig. 10, which gives the results on the test section with a two-inch gauge length, that the waviness had been reduced to the standard of ± 1 thousandth of an inch variation from the mean deflection curve with a two-inch gauge length on the whole of the test section except for two points on the bottom surface. Figs. 11 and 12, which give the comparable values to Figs. 7 and 8, show that the waviness had been considerably reduced over the rest of the wings.

The results of the profile-drag measurements made with the test section in this new condition are given in Fig. 13. The profile-drag coefficients are plotted against lift coefficient for all cases in which it appeared that no flies or other insects were picked up during the flight. It will be seen that the drag coefficient has been reduced over the whole low-drag range, the greatest improvement being at the higher Reynolds number end. The lowest lift coefficient recorded was 0.097 (corresponding to a Reynolds number of nearly 20 millions) and the drag coefficient at this point was 0.0049. For comparison, the drag curve obtained in the previous flight tests is also plotted on Fig. 13, and it will be seen that the drag coefficient for a lift coefficient of 0.097 was then 0.0066, the present tests thus showing a reduction in drag of 26 per cent.

The low-drag range extended from a lift coefficient of 0.15 to 0.50, thus confirming the results of the pressure plotting. The slight rise in profile-drag coefficient at lift coefficients of less than 0.15 probably arises because the waviness of the bottom surface did not meet the required standard at all points; the bottom surface will be the more critical at high speeds due to the decreasing incidence.

In Fig. 14 are shown the results of all the flights made, including those during which flies and other insects were picked up. The increase in drag due to flies will be seen to be quite large and it is clear that, unless some means can be found to prevent the insects sticking to the surface, the full advantage of smooth low-drag sections will not be achieved in practice.

4.3. *Profile Drag with Fixed Transition.*—During the first series of tests, an attempt was made to measure the section drag with fixed transition. The results of these measurements reduced to a mean lift coefficient, which were obtained by fixing adhesive tapes to the wing surface at 10 per cent and 30 per cent chord on both surfaces, are shown in Fig. 15 as a function of tape height. It will be seen that one layer of tape at 10 per cent chord or two layers at 30 per cent were apparently sufficient to produce complete transition at the respective positions. Tests with wire held on by one layer of adhesive tape confirmed the results with tape only (Fig. 15). The slight rise in the curve with increasing tape height is due to the drag of the tape itself and the true drag coefficient corresponding to a fixed transition point was obtained by extending the curves back to zero tape height.

The results are shown in Fig. 16 in the form of profile-drag coefficient against transition point: the theoretical relation³ is also shown. A similar discrepancy between flight results and theory was obtained in the tests on the *King Cobra*²: the discrepancy is probably due to the nature of the transition which may, under the existing favourable pressure gradient, extend over 20 per cent chord behind the disturbance on the surface before full turbulent flow is established. The theory assumes instantaneous transition at the disturbance.

The point is of some interest since it implies that with an aerofoil of low-drag design on which, owing to poor manufacture at some point on the surface, full laminar flow is not achieved, the rise in drag will be appreciably less than that indicated by theory assuming transition to occur at that point.

5. *Maintenance of the Surface.*—Most of the surface held very well during both series of tests; however, during the second series of tests, at two points on the port wing, chordwise cracks developed and extended from the leading edge to about 60 per cent chord on the bottom surface, though on the top surface it only extended to about 4 per cent back. One of these cracks was only two inches outboard of the test section and required filling and rubbing down after each flight.

No trouble was experienced with the drying out of the filler, though it was noticed that a substance, which presumably had been used in processing the wing, tended to ooze out of the skin joints and around the rivet heads.

6. *Conclusions.*—The results of the pressure plotting on the test section gave good agreement with theory and confirm the design requirements.

A fairly low profile-drag coefficient was obtained in the first series of tests, although full laminar flow was not achieved due to excessive surface waviness. A great improvement was achieved at high Reynolds numbers by reducing the surface waviness to ± 1 thousandth of an inch variation from the mean deflection curve on a two-inch gauge length. It is concluded that it is essential for the maintenance of laminar flow at Reynolds numbers of the order of 20 millions that the surface waviness should not be larger than this. The same conclusion was reached during

flight tests of *King Cobra* FZ.440² when drag coefficients of the order of 0.0028 were measured after the surface waviness had been reduced to this standard. The slight rise in profile-drag coefficient at high Reynolds numbers in the second series of tests is probably due to the fact that the surface waviness did not meet the above requirements at all points on the surface. The main improvements brought about by smoothing down the wing surface are as follows:—

- (1) the profile-drag coefficient has been reduced from $C_D = 0.0046 - 0.0050$ to $C_D = 0.0044$;
- (2) the low-drag range has been extended from $C_L = 0.17 - 0.45$ to $C_L = 0.15 - 0.50$ which is in good agreement with the pressure plotting results; and
- (3) laminar flow has been maintained over more than half the aerofoil surface at Reynolds numbers of up to 20 millions.

A similar discrepancy between flight results and theory on the transition-drag relation to that found in the tests on the *King Cobra*² was found in these tests. It is thought that the explanation lies in the nature of the transition behind a disturbance on the wing.

REFERENCES

No.	Author	Title, etc.
1	J. S. Thompson	A Simple Method of Computing C_D from Wake Traverses at High Speeds. A.R.C. 8462. 1944. (Unpublished.)
2	F. Smith and D. J. Higton ..	Flight Tests on "King Cobra" FZ.440 to Investigate the Practical Requirements for the Achievement of Low Profile Drag Coefficients on a Low Drag Aerofoil. R. & M. 2375. August, 1945.
3	N. E. Winterbottom and H. B. Squire	Note on Further Wing Profile Drag Calculations. A.R.C. 4871. 1940. (Unpublished.)

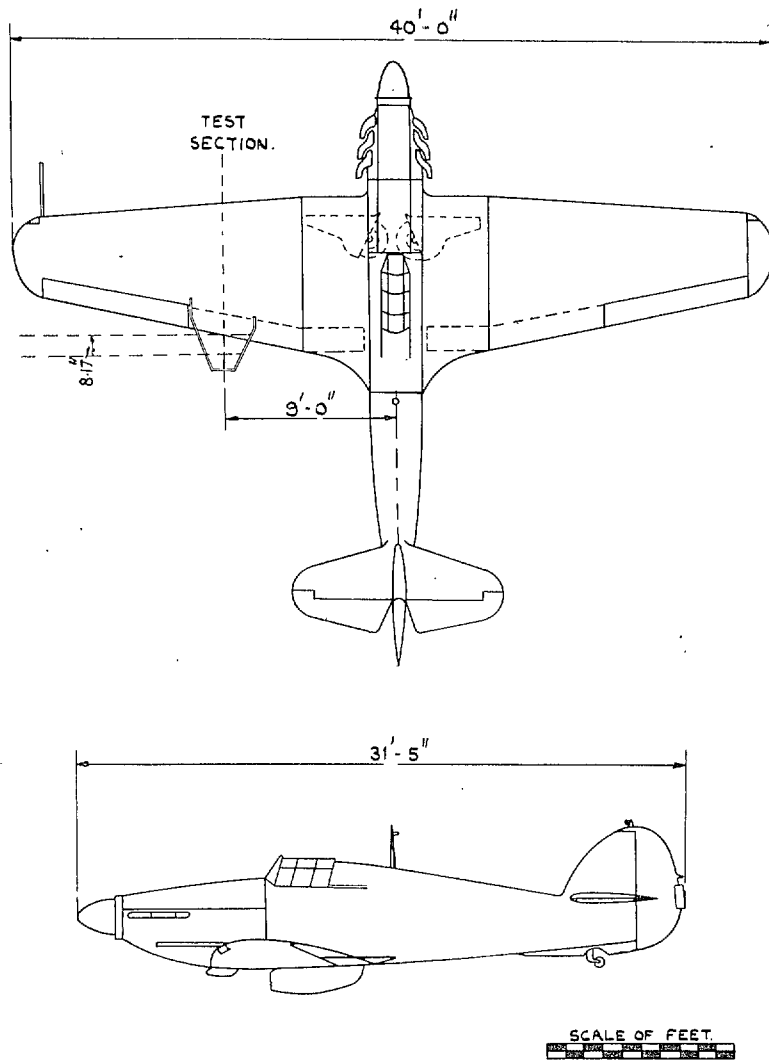
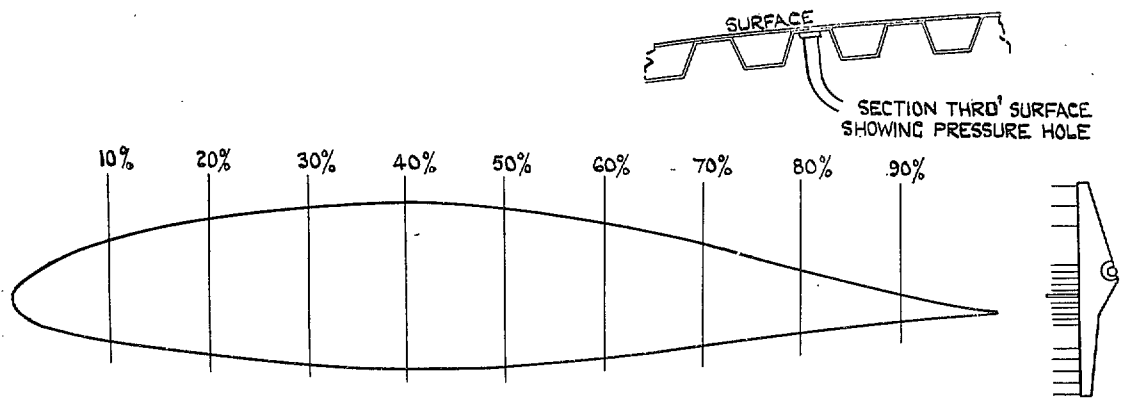

FIG. 1. General arrangement of *Hurricane Z.3687*.



TEST SECTION CHORD 82.3 INCHES — MAX. THICKNESS 17.2% AT 42.4% CHORD.

FIG. 2. Profile of test section showing comb.

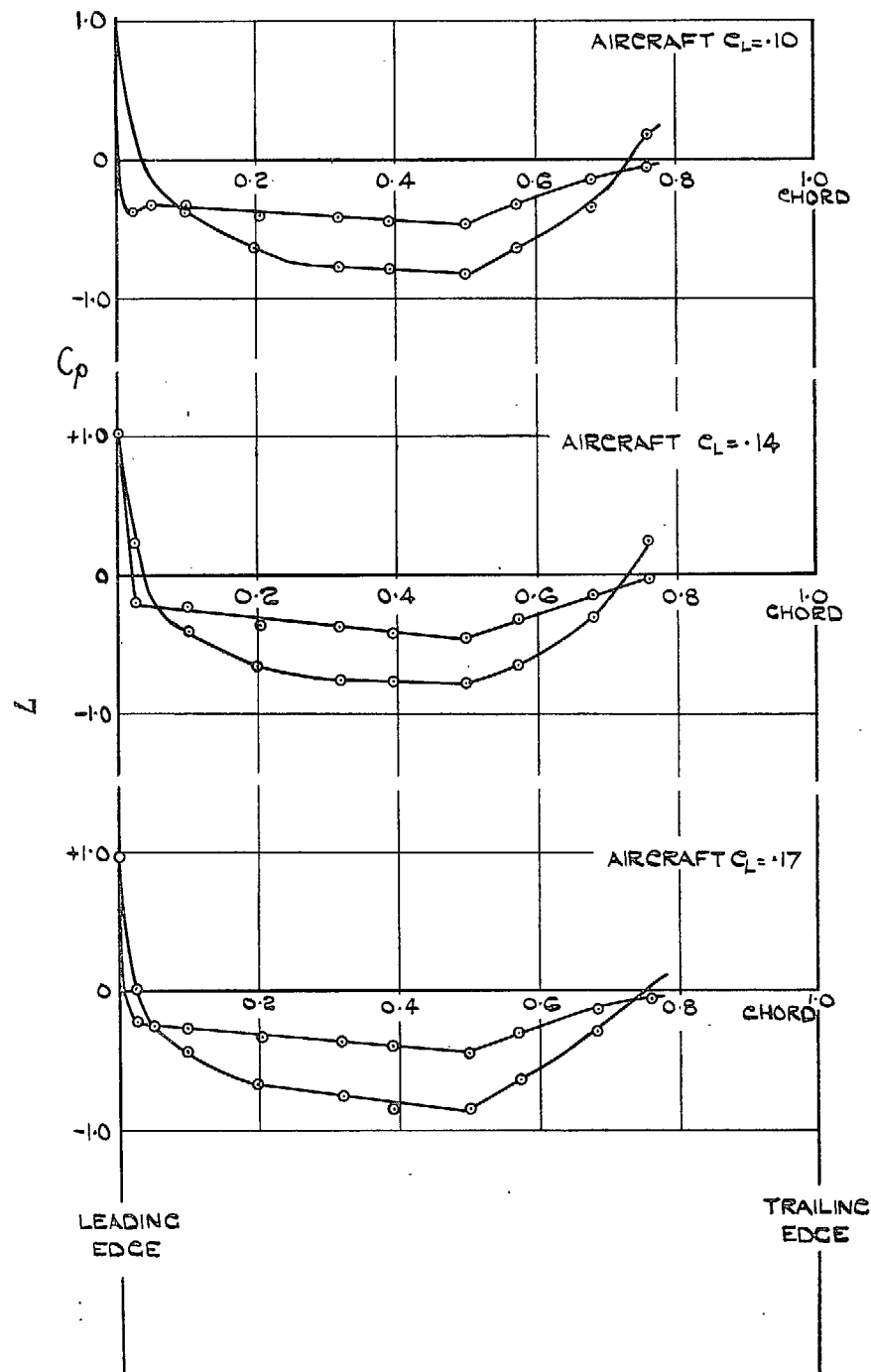

FIG. 3. Pressure distribution on test section.

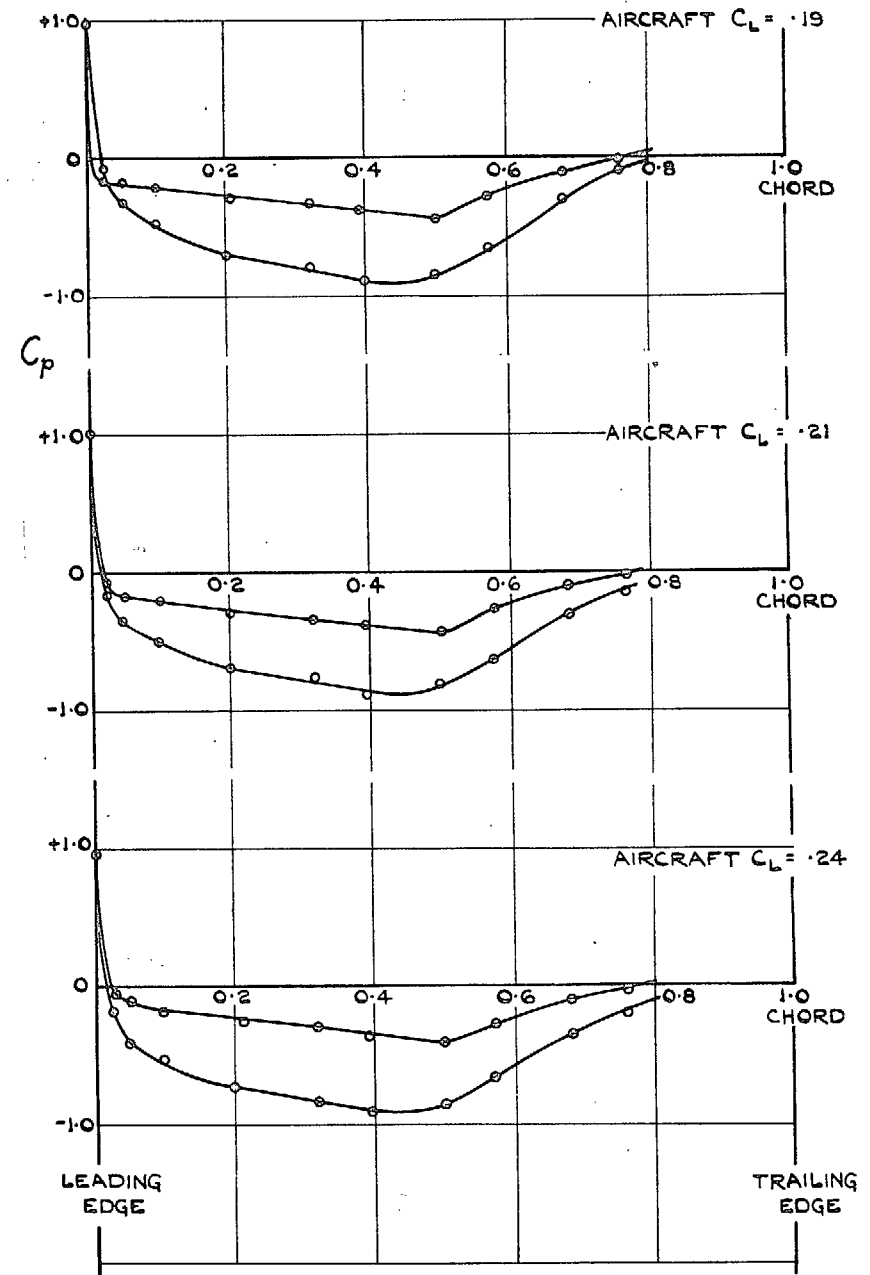

FIG. 4. Pressure distribution on test section.

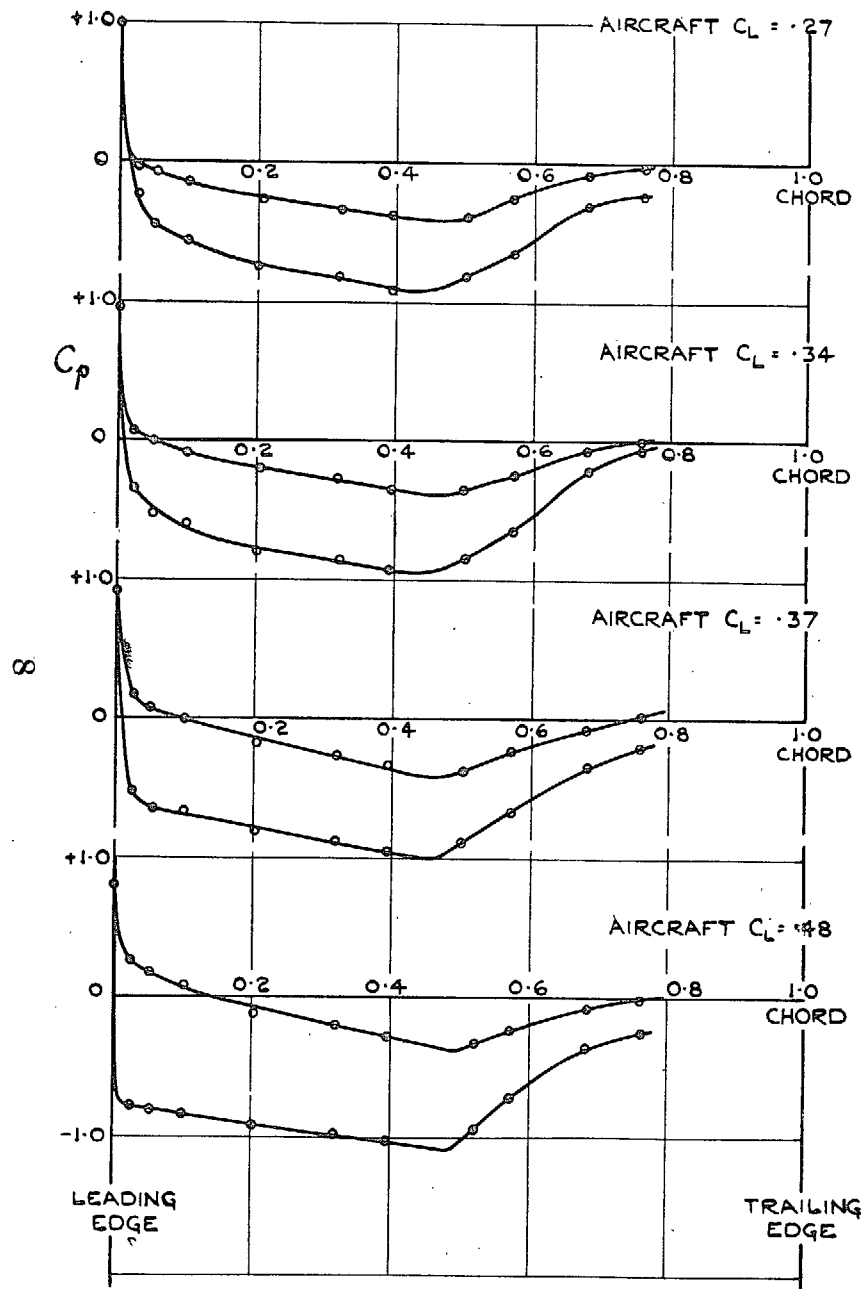

FIG. 5. Pressure distribution on test section.

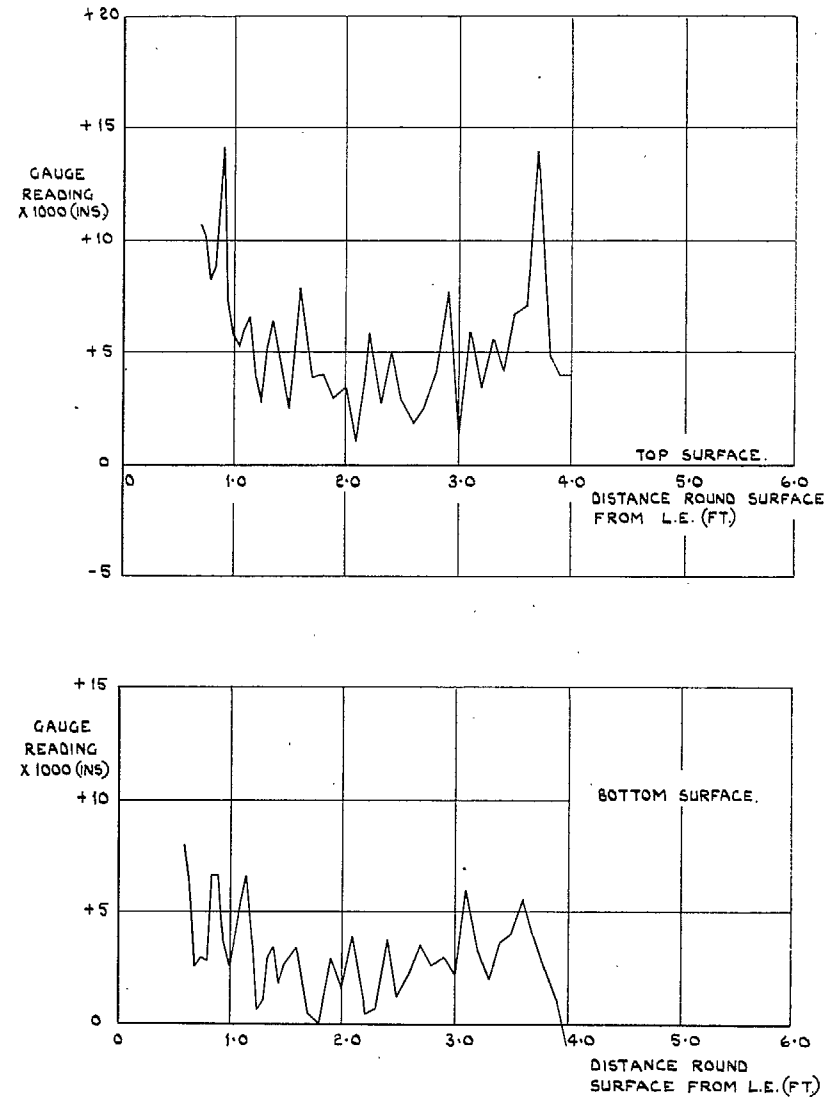

FIG. 6. Test section surface waviness as measured by curvature gauge with two-inch base.

6

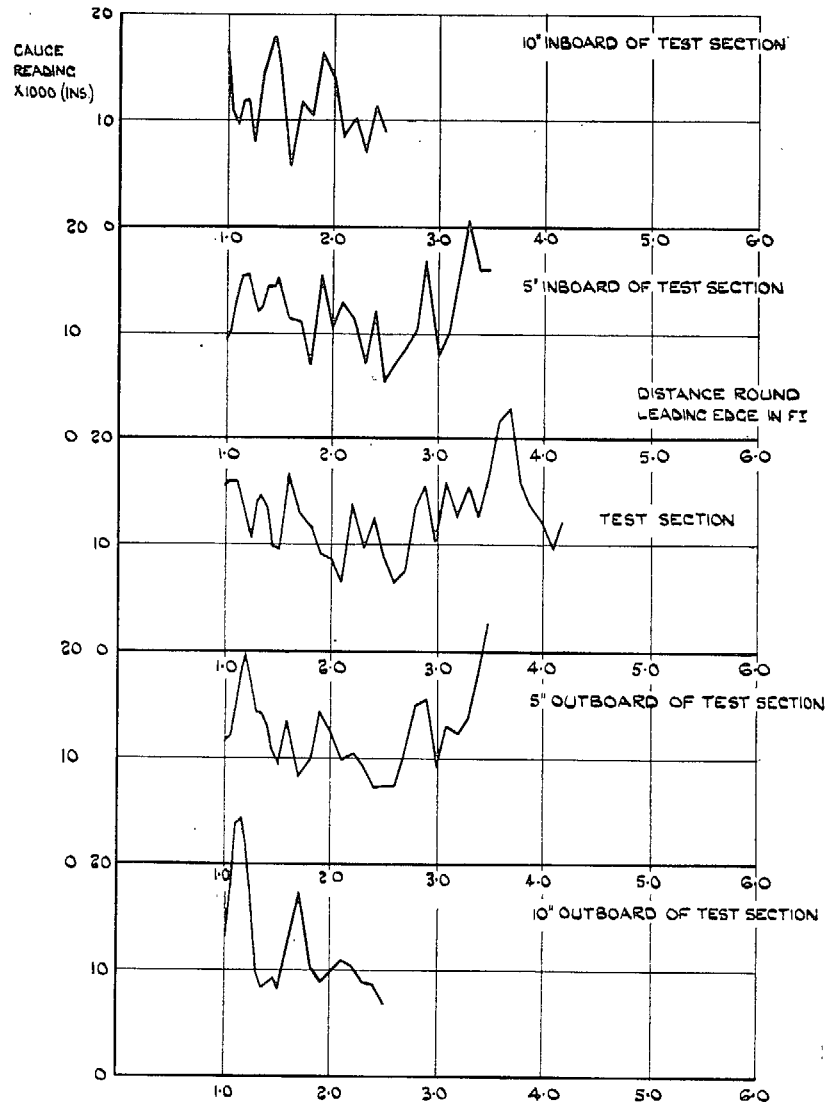

FIG. 7. Top surface waviness as measured by curvature gauge with three-inch base.

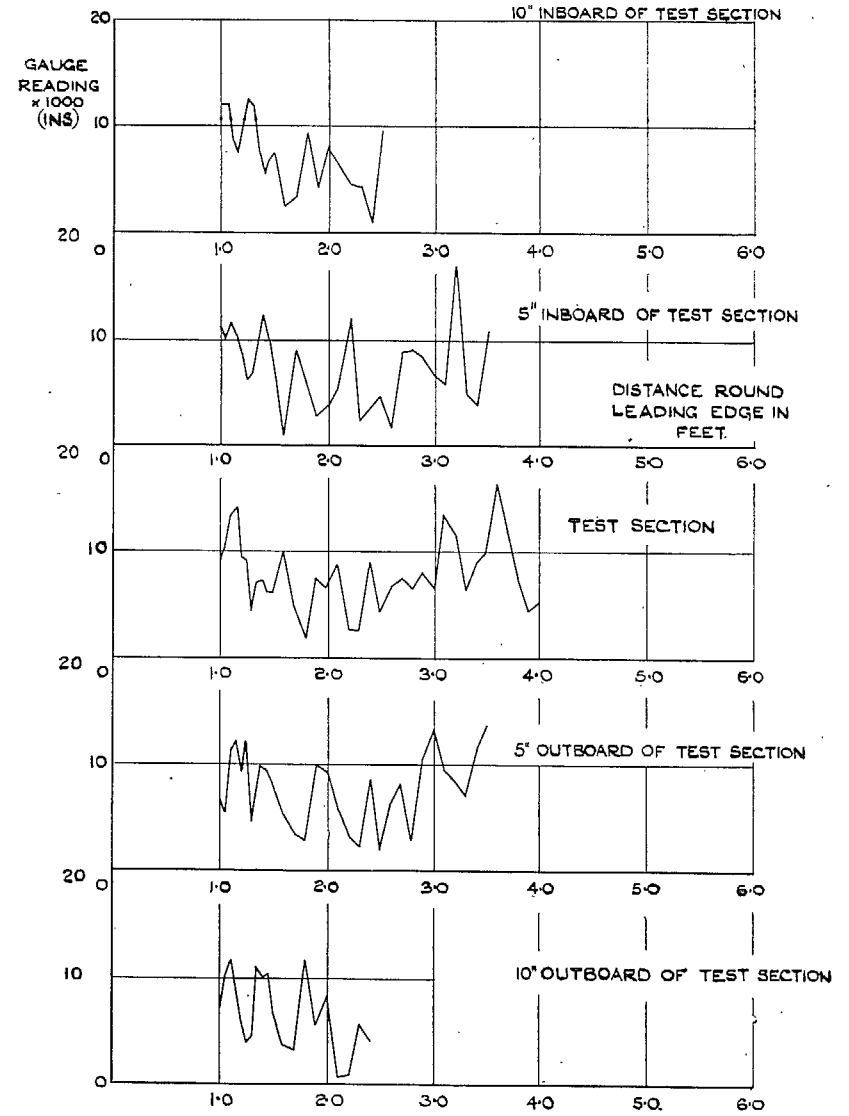

FIG. 8. Bottom surface waviness as measured by curvature gauge with three-inch base.

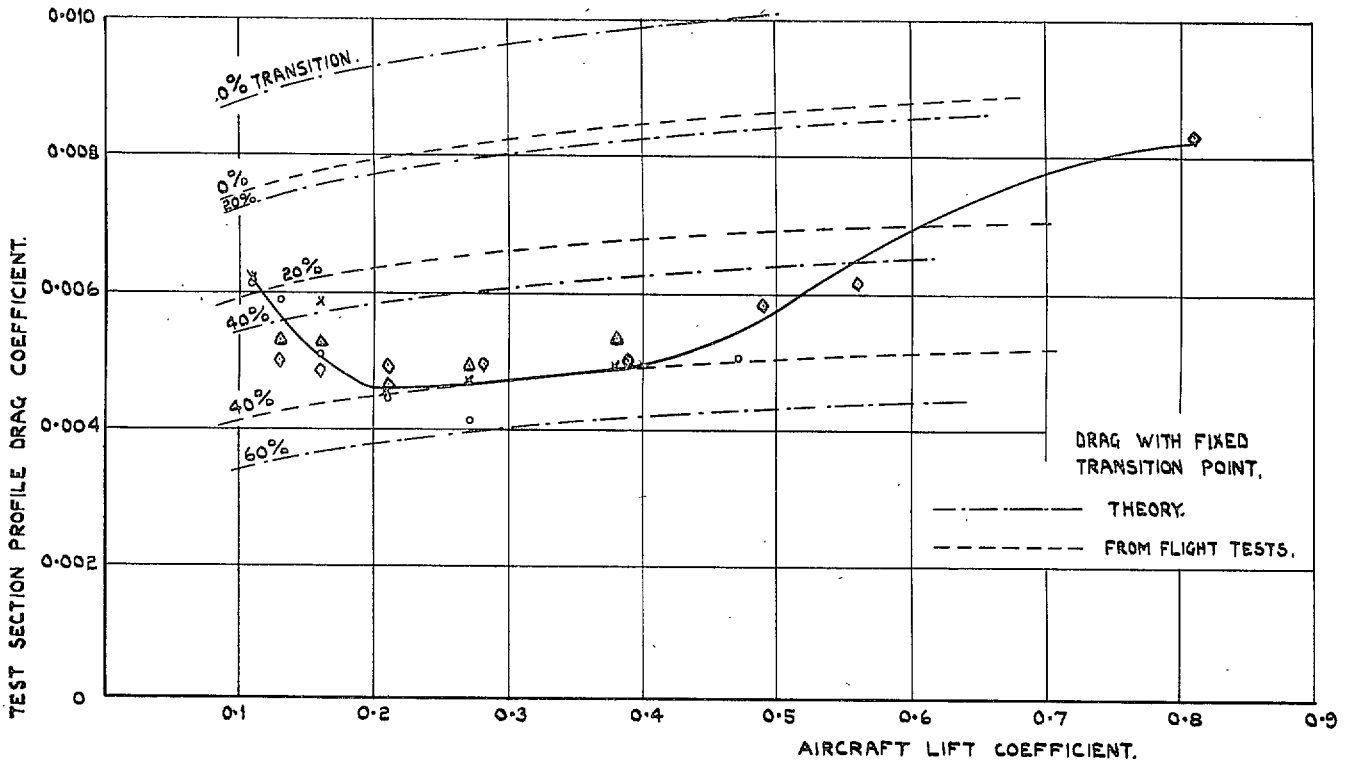

FIG. 9. Section profile-drag coefficient obtained from flight tests.

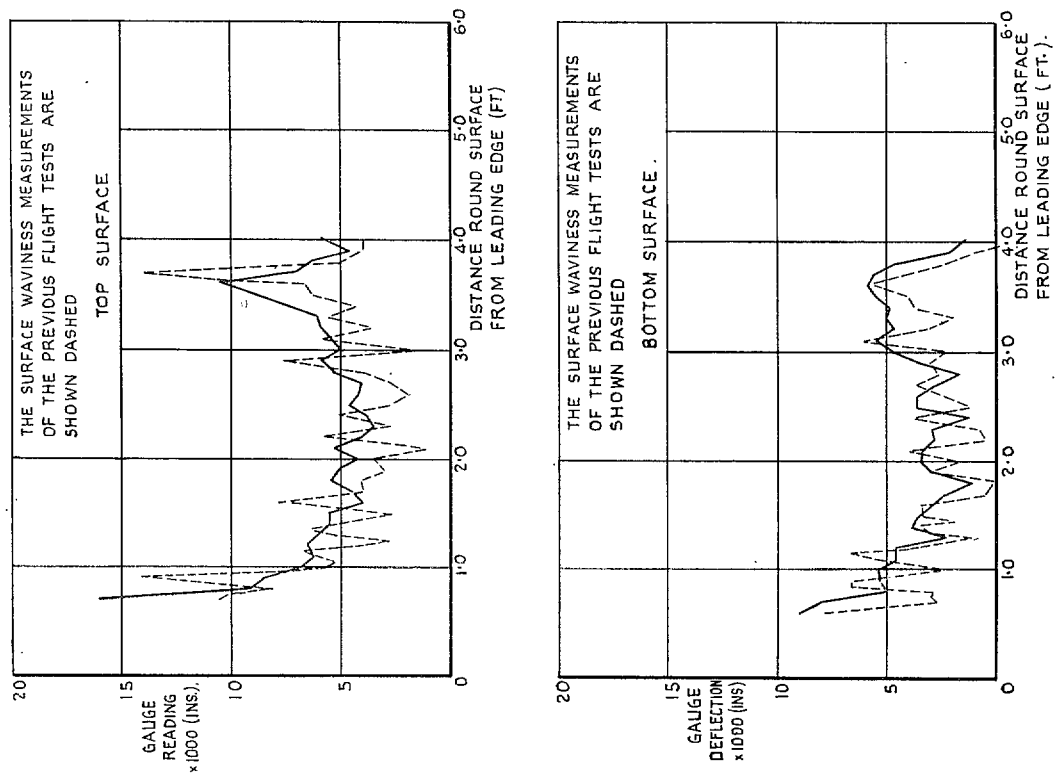

FIG. 10. Test section surface waviness as measured by curvature gauge with two-inch base.

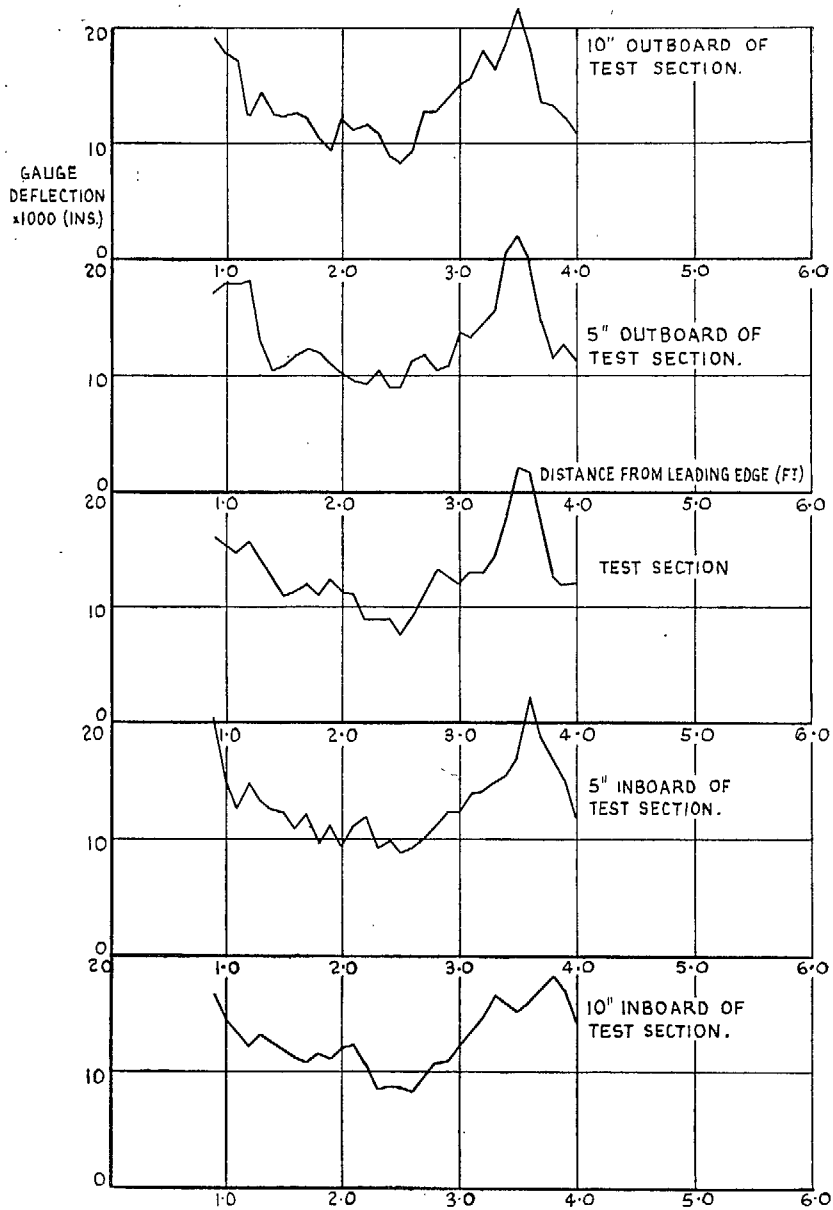

FIG. 11. Top surface waviness as measured by curvature gauge with three-inch base.

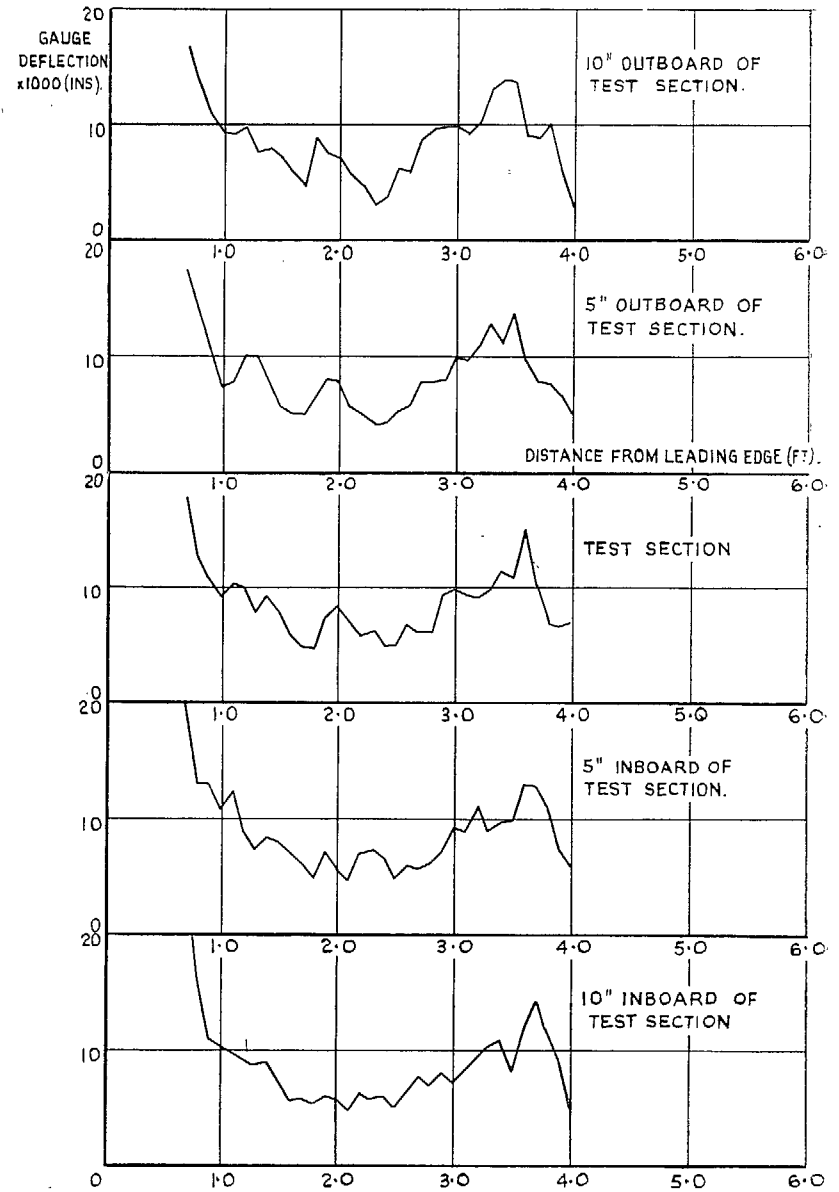

FIG. 12. Bottom surface waviness as measured by curvature gauge with three-inch base.

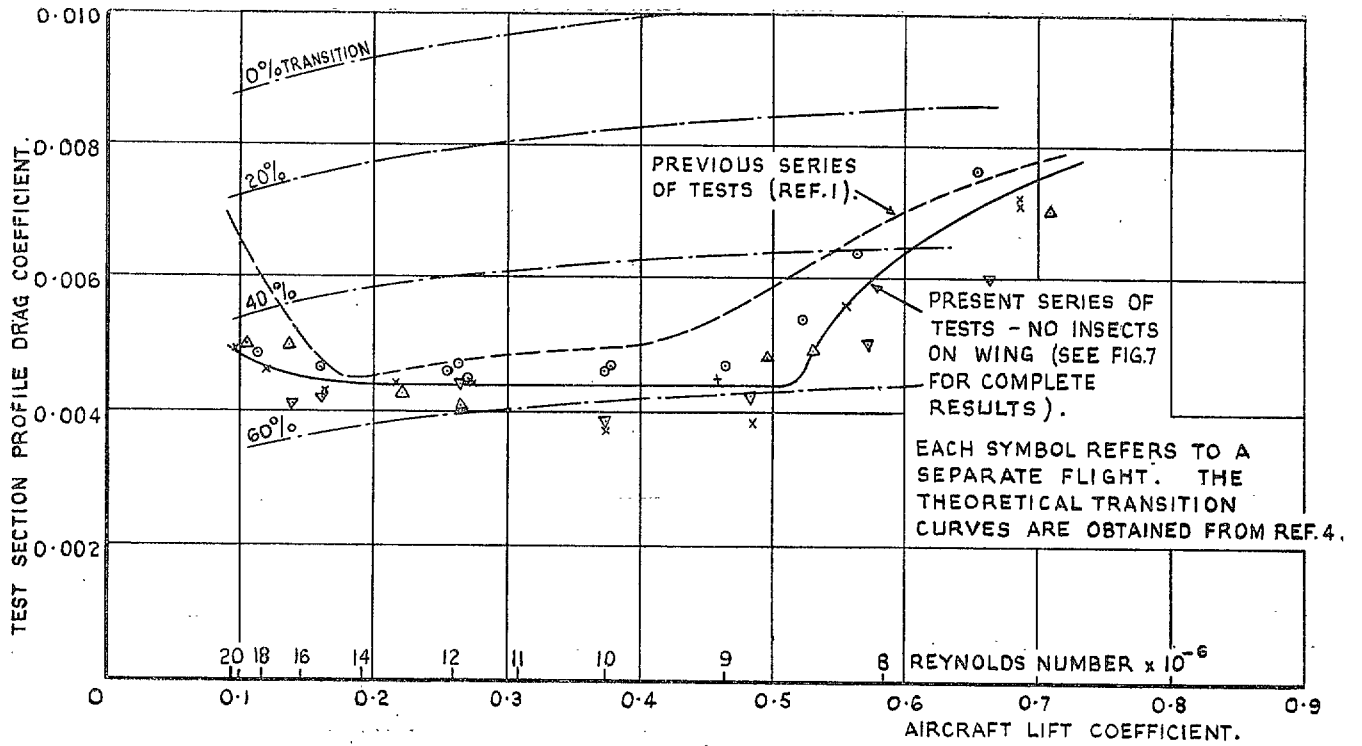

FIG. 13. Section profile drag obtained from flight tests.

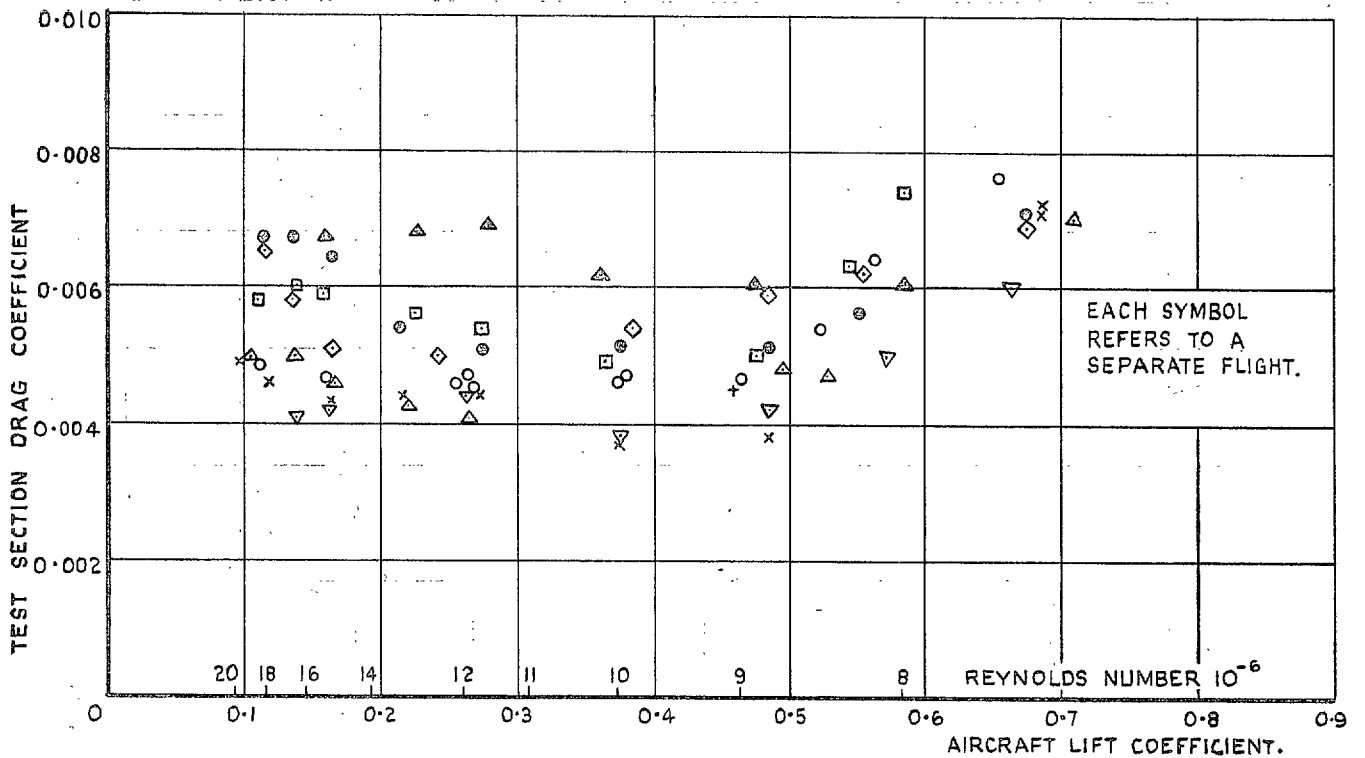

FIG. 14. Results from all flights—including those during which flies or other insects were picked up.

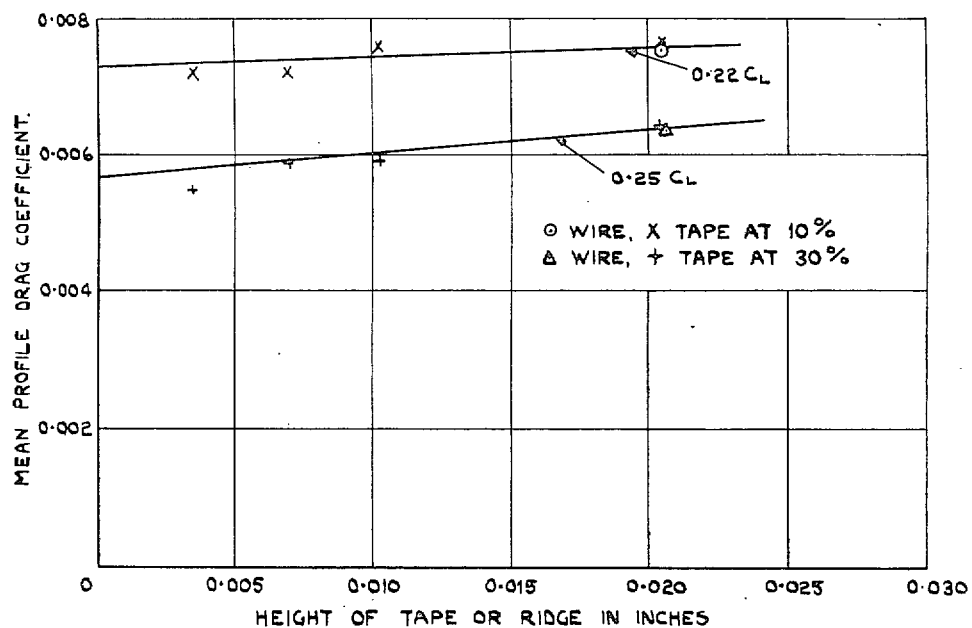

FIG. 15.

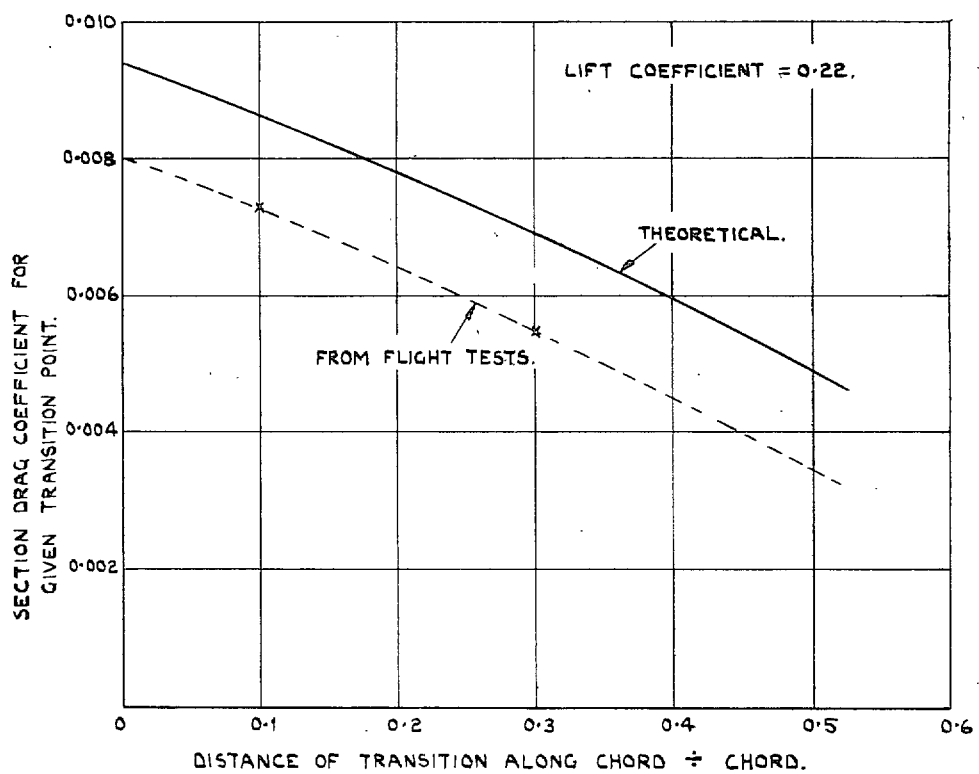

FIG. 16.

Publications of the Aeronautical Research Council

ANNUAL TECHNICAL REPORTS OF THE AERONAUTICAL RESEARCH COUNCIL (BOUND VOLUMES)—

- 1934-35 Vol. I. Aerodynamics. *Out of print.*
Vol. II. Seaplanes, Structures, Engines, Materials, etc. 40s. (40s. 8d.)
- 1935-36 Vol. I. Aerodynamics. 30s. (30s. 7d.)
Vol. II. Structures, Flutter, Engines, Seaplanes, etc. 30s. (30s. 7d.)
- 1936 Vol. I. Aerodynamics General, Performance, Airscrews, Flutter and Spinning.
40s. (40s. 9d.)
Vol. II. Stability and Control, Structures, Seaplanes, Engines, etc. 50s. (50s. 10d.)
- 1937 Vol. I. Aerodynamics General, Performance, Airscrews, Flutter and Spinning.
40s. (40s. 10d.)
Vol. II. Stability and Control, Structures, Seaplanes, Engines, etc. 60s. (61s.)
- 1938 Vol. I. Aerodynamics General, Performance, Airscrews. 50s. (51s.)
Vol. II. Stability and Control, Flutter, Structures, Seaplanes, Wind Tunnels,
Materials. 30s. (30s. 9d.)
- 1939 Vol. I. Aerodynamics General, Performance, Airscrews, Engines. 50s. (50s. 11d.)
Vol. II. Stability and Control, Flutter and Vibration, Instruments, Structures,
Seaplanes, etc. 63s. (64s. 2d.)
- 1940 Aero and Hydrodynamics, Aerofoils, Airscrews, Engines, Flutter, Icing, Stability
and Control, Structures, and a miscellaneous section. 50s. (51s.)

*Certain other reports proper to the 1940 volume will subsequently be
included in a separate volume.*

ANNUAL REPORTS OF THE AERONAUTICAL RESEARCH COUNCIL—

1933-34	1s. 6d. (1s. 8d.)
1934-35	1s. 6d. (1s. 8d.)
April 1, 1935 to December 31, 1936.	4s. (4s. 4d.)
1937	2s. (2s. 2d.)
1938	1s. 6d. (1s. 8d.)
1939-48	3s. (3s. 2d.)

INDEX TO ALL REPORTS AND MEMORANDA PUBLISHED IN THE ANNUAL TECHNICAL REPORTS, AND SEPARATELY—

April, 1950 R. & M. No. 2600. 2s. 6d. (2s. 7½d.)

INDEXES TO THE TECHNICAL REPORTS OF THE AERONAUTICAL RESEARCH COUNCIL—

December 1, 1936 — June 30, 1939.	R. & M. No. 1850.	1s. 3d. (1s. 4½d.)
July 1, 1939 — June 30, 1945.	R. & M. No. 1950.	1s. (1s. 1½d.)
July 1, 1945 — June 30, 1946.	R. & M. No. 2050.	1s. (1s. 1½d.)
July 1, 1946 — December 31, 1946.	R. & M. No. 2150.	1s. 3d. (1s. 4½d.)
January 1, 1947 — June 30, 1947.	R. & M. No. 2250.	1s. 3d. (1s. 4½d.)

Prices in brackets include postage.

Obtainable from

HER MAJESTY'S STATIONERY OFFICE

York House, Kingsway, LONDON, W.C.2 423 Oxford Street, LONDON, W.1
P.O. Box 569, LONDON, S.E.1
13a Castle Street, EDINBURGH, 2 1 St. Andrew's Crescent, CARDIFF
39 King Street, MANCHESTER, 2 Tower Lane, BRISTOL, 1
2 Edmund Street, BIRMINGHAM, 3 80 Chichester Street, BELFAST

or through any bookseller.