

C.P. No. 341

(18,100)

A.R.C. Technical Report

C.P. No. 341

(18,100)

A.R.C. Technical Report

LIBRARY
ROYAL AIRCRAFT ESTABLISHMENT
BEDFORD.



MINISTRY OF SUPPLY

AERONAUTICAL RESEARCH COUNCIL

CURRENT PAPERS

**Full Scale Measurements of Impact Loads on
a Large Flying Boat (Sunderland Mk. 5)
Part IV - Data for Impacts on the Afterbody**

By

R. Parker, B.Sc.

LONDON . HER MAJESTY'S STATIONERY OFFICE

1957

FIVE SHILLINGS NET

C.P. No. 341
Report No. F/Res/260

August 1954

MARINE AIRCRAFT EXPERIMENTAL ESTABLISHMENT, FELIXSTOWE, SUFFOLK

FULL SCALE MEASUREMENTS OF IMPACT LOADS ON
A LARGE FLYING BOAT (SUNDERLAND 5)

PART IV. DATA FOR IMPACTS ON THE AFTERBODY

by

R. PARKER, B.Sc.

S U M M A R Y

A comprehensive series of landing impact tests has been carried out by M.A.E.E. in both calm and rough water on a Sunderland flying boat.

Results are given in this report for landings in calm water at attitudes where appreciable pressures occur on the afterbody and comprise data on total forces and local pressures on the afterbody.

/LIST OF CONTENTS

LIST OF CONTENTS

1. Introduction.
2. Aircraft.
3. Instrumentation.
 - 3.1. Total forces.
 - 3.2. Pressures.
 - 3.3. Attitude and roll.
 - 3.4. Vertical and horizontal velocities and draught.
 - 3.5. Recording.
 - 3.6. Accuracy.
4. Range of Tests and Pilot Technique.
5. Results.
6. General Remarks.

LIST OF TABLES

	<u>Table No.</u>
Sunderland Mk.5 Data.	I
Details of Individual Pressure Pick-Up Positions.	II

LIST OF FIGURES

	<u>Figure No.</u>
Sunderland Mk.5 flying boat. General arrangement and positions of masses in wings.	1
Sunderland Mk.5 hull lines.	2
Positions of pressure pick-ups used.	3
Total impact results for run no. 11/5.2.52	4
Pressure results for run no. 11/5.2.52	4A
Total impact results for run no. 4/11.2.52	5
Pressure results for run no. 4/11.2.52	5A
Total impact results for run no. 13/5.2.52	6
Pressure results for run no. 13/5.2.52	6A
Total impact results for run no. 4/8.8.51	7

LIST OF FIGURES (Contd.)

	<u>Figure No.</u>
Pressure results for run no. 4/8.8.51	7A
Total impact results for run no. 2/8.8.51 (First impact)	8
Pressure results for run no. 2/8.8.51 (First impact)	8A
Total impact results for run no. 2/8.8.51 (Second impact)	9
Pressure results for run no. 2/8.8.51 (Second impact)	9A
Total impact results for run no. 11/29.1.52	10
Pressure results for run no. 11/29.1.52	10A
Total impact results for run no. 10/11.2.52	11
Pressure results for run no. 10/11.2.52	11A
Total impact results for run no. 13/29.1.52	12
Pressure results for run no. 13/29.1.52	12A
Total impact results for run no. 10/24.4.51	13
Pressure results for run no. 10/24.4.51	13A
Total impact results for run no. 7/24.4.51	14
Pressure results for run no. 7/24.4.51	14A
Total impact results for run no. 11/24.4.51	15
Pressure results for run no. 11/24.4.51	15A
Lift curve for Sunderland Mk.5 with 2/3rd flap.	16

1. INTRODUCTION

A comprehensive range of tests has been carried out by M.A.E.E. on a standard Sunderland Mark 5 flying boat in three series viz. calm water tests where the forebody only is affected, calm water tests where the afterbody plays an appreciable part and rough water tests.

The results of the first series (forebody impact tests) are recorded as data in Reference 1 and compared with the relevant theory in Reference 2. The purpose of this report is to present, as straightforward data, the results of the second series, i.e. tests at high attitudes where the afterbody is subjected to appreciable local pressures and suction and the forces on it form an appreciable part of the total.

There is at the moment no theory with which these results can be directly compared, even the case of the forebody only with no rotation in pitch has not been successfully treated theoretically. Where the afterbody plays an important part, appreciable rotation in pitch occurs and except for the very early part of the impact, the afterbody is planing in the wake of the forebody which results in a complicated surface shape.

The immediate uses therefore to which the present results may be usefully applied are direct comparison with existing seaworthiness requirements and any other empirical method of establishing the pressures and forces to be allowed for in seaplane hull design.

2. AIRCRAFT

The aircraft employed was a standard Sunderland Mark 5 flying boat with four Pratt and Whitney twin Wasp engines. A general arrangement drawing of the aircraft is given in Figure 1, and a lines plan in Figure 2.

As the flexibility of the wings may have an appreciable effect on the impact, Figure 1 includes a general indication of the major concentrations of mass in the aircraft, as loaded for the tests.

3. INSTRUMENTATION.

The apparatus used is basically similar to that which was used for the earlier tests on the forebody and is discussed in Reference 3. Certain items of equipment have, however, been changed for similar ones of different manufacture, and the main difference is that considerably less recorder channels were available. A brief survey of the various items is given below.

3.1. Total forces

The method of combining the outputs of several accelerometers described in Reference 3 was not used as examination of previous work shows the centre section acceleration, when oscillatory components are meaned out, to resemble the correct C.G. acceleration within fair limits.

In this case two accelerometers were used, one placed on the main spar centre section (just forward of the C.G.) and one above and slightly forward of the rear step. During the earlier tests (Reference 1, the main spar centre section acceleration was considered to be the same as the C.G. acceleration as the tests concerned involved little or no angular acceleration. In the current tests, this is not the case and the outputs of the two accelerometers fitted have been used to calculate an actual C.G. acceleration and a pitching acceleration.

3.2. Pressures

The pressures on the planing bottom were measured by means of flush diaphragm pressure pick-ups, similar in principle to those described in Reference 3, but re-designed with a more robust construction of an inherently water-proof nature, which resulted in better serviceability.

3.3. Attitude and roll

Attitude was measured by means of an Anschutz gyroscope and, while roll was indicated at the observer's position, this was not recorded and runs where it was observed to deviate appreciably from zero were discarded.

3.4. Vertical and horizontal velocities and draught

The aircraft position at any instant was recorded by means of a high speed camera, mounted on an accurately-aligned tripod at a suitable shore position.

Analysis of this photographic record enabled calculations to be made of vertical and horizontal velocity, draught and keel angle. The latter is a duplication of the attitude measured by the gyroscope and forms a convenient check on the accuracy achieved by the two methods.

3.5. Recording

Measurements under Sections 3.1, 3.2 and 3.3 were recorded on one 12-channel galvo-camera recorder, manufactured by Films & Equipment Ltd.

The attitude was obtained by an electrical signal directly from the gyroscope and fed straight to the galvanometer, while the accelerometers and the pressure pick-ups worked in conjunction with two 6-channel amplifier units, manufactured by McMichael Radio Ltd.

Timing systems were incorporated in both the recorder and the shore camera, and accurate synchronisation was achieved by firing a flash bulb from the aircraft, which was visible from the shore camera position, simultaneously with the application of an event signal in the recorder.

3.6. Accuracy

The accuracy achieved in the various measurements has been assessed in Reference 3, and is as follows:

Attitude	$\pm 0.5^\circ$
Draught	± 0.2 ft.
Vertical velocity	± 1 ft./sec.
Forward velocity	± 2 ft./sec.
Time	$\pm 0.1\%$ (synchronisation ± 0.01 sec.)
Acceleration	$\pm 0.1g$.
Pressures	$\pm 5\%$ (The minimum time of pressure build-up which can be recorded is 0.01 sec.)

4. RANGE OF TESTS AND PILOT TECHNIQUE

The object of the current series of tests was to investigate conditions where the rear step played an important part in the impact conditions and did not conform to those assumed in the current hydrodynamic impact theories with regard to angular velocity and immersion of the rear step. Conditions to which the pilot was instructed to conform were:

/(a)

- (a) zero vertical acceleration prior to touchdown,
- (b) zero drift at touchdown, and
- (c) zero angle of roll throughout the impact.

The piloting technique used was similar to that described in Reference 2, except that the instructions included an approximate indicated airspeed and a statement that the vertical velocity should be either higher or lower than the previous tests.

In all landings, the elevators and engine settings were left constant during the impact and for as long as possible before this though, in the higher attitudes the aircraft was near to stalling and continuous control by the pilot was necessary.

To achieve the low indicated airspeeds and, therefore, high attitudes, it was necessary for a considerable amount of engine power to be used throughout the impact, and the condition of zero acceleration prior to touchdown was very difficult to achieve.

All tests were made at one weight and C.G. position, i.e. 50,000 lb. all-up weight, with C.G. 3 ft. forward of the main step point, measured parallel to hull datum and all landings were done in the normal landing configuration, i.e. two-thirds flap and in good weather conditions, with winds of, on an average, 3-4 knots, giving a relatively calm water surface, with the roughest conditions consisting of wavelets not more than 6 ins. high.

5. RESULTS

The results are given in Figures 4-15, and comprise time histories of keel attitude, main step and rear step draught, main step and rear step vertical velocity, forward velocity, C.G. vertical acceleration, pitching acceleration and pressures at a number of individual points on the afterbody, with one or two points on the forebody near the main step to give a direct comparison. The positions of the pressure points used are given in Figure 3, and relevant dimensions in Table II.

The numbers used to identify the runs consist of the date of the test preceded by the number of the run on that particular day. The completeness of results is severely impaired by the small number of recorder channels available, and each run contains only pressure records for a limited area of the afterbody or a very scattered survey of the whole afterbody.

The draught results contain curves for main step and rear step, both of which have been obtained by two methods, i.e. from the shore camera record and by double integration of acceleration records. In many cases, good agreement was achieved and only one curve is presented. Where this is not the case, the two separate curves are plotted and an indication is therefore given of the accuracy of the results.

Owing to the change in flight path angle and the large changes in attitude during an impact, the wing lift will change appreciably. To permit calculation of the magnitude of this effect, lift curves measured on the actual aircraft used are given in Figure 16 for the condition with two-thirds flap.

It will be noted that there is a difference between the level flight and glide curves and, as the amount of engine power used on any particular run is not recorded, it is difficult to say which curve gives the best approximation but, in general, the level flight curve is likely to be the nearest.

6. GENERAL REMARKS

No analysis of the results is attempted in this report as its purpose is to make available the measured data obtained but a few general points are noted below.

The maximum C.G. acceleration and maximum pitching acceleration both occur late in the impact and result from forebody forces, the initial nose down pitching acceleration due to afterbody forces rarely exceeding 0.7 rad/sec. (shown as a negative value in the plots).

While forebody pressures up to 30 P.S.I. are recorded pressures on the afterbody rarely exceeds 10 P.S.I. and no significant pressures were recorded at positions forward of No.24 (Fig.3). Negative pressures (or suction) of nearly 10 P.S.I. below atmospheric were measured aft of the main step and significant suction were measured as far back as position No.26.

Afterbody pressures all disappear after the forebody has been immersed long enough to form an appreciable wake - more pressures would occur later but the current work is concerned only with the early part of the landings at high planning speeds.

References/

References

<u>No.</u>	<u>Author(s)</u>	<u>Title, etc.</u>
1	R. Parker	Full scale measurements of impact loads on a large flying boat (Sunderland Mk. 5). Part III - Data for impacts on main step. C.P. No. 340. August, 1954.
2	J. A. Hamilton	Full scale measurements of impact loads on a large flying boat (Sunderland Mk. 5). Part II - Results for impact on the main step. C.P. No. 205. February, 1951.
3	J. W. Mc.Ivor	Full scale measurements of impact loads on a large flying boat (Sunderland Mk. 5). Part I - Description of apparatus and instrument installation. C.P. No. 182. March, 1950.

Table I/

TABLE I

Sunderland Mark 5
Data

Hull

Beam (max)	9.79 ft.
Length (F.P. to Rear Step)	62.12 ft.
Length: Beam Ratio	6.35
Forebody Length (F.P. to Main Step Keel)	32.94 ft.
Afterbody Length (Main Step Keel to Aft step)	29.18 ft.
Keel-Chine Deadrise at Main Step	26°
Step Plan Included Angle	132°
Forebody Keel - Hull Datum Angle	3°
Heel - Heel Angle	9° 17'
Forebody Keel - Afterbody Keel Angle	7° 29'
Main Step Fairing Ratio	6:1

Wings

Area (gross)	1687 sq.ft.
Span	112.8 ft.
Incidence to Hull Datum	6° 9'
Section	Gottingen 436 modified

Flaps

Type	Gouge
Area	286 sq.ft.

Tailplane

Area (including elevators)	205 sq.ft.
Elevator area (including tabs)	84.5 sq.ft.
Elevator movement	16° 30' up and down

Engines

4 Pratt Whitney Twin Wasp R. 1830-90B giving 1200 B.H.P. at 2,700 r.p.m. and + 9 lb/sq.in. boost for sea level take-off.

Loading

At A.U.Wt. 50,000 lb

C.G. "Normal" is 3.02 ft. forward of main step at keel parallel to hull datum line.

TABLE II
Details Of Individual Pressure
Pick-up Positions

Pick-up No.	l (in)	l'(in)	b(in)	c(in)	∅L
15	33.8		7.6	8.9	31.0°
20	13.7		7.6	9.0	31.0°
31		346.75	13.59	16.34	36.75°
32		356.75	33.84	40.0	
33		319.25	10.44	12.36	35.66°
35		278.25	13.04	15.34	34.25°
21		237.25	6.7	8.8	38.5°
22		237.25	36.8	43.9	28.0°
23		201.50	6.4	8.3	37.5°
24		175.75	6.4	8.1	37.0°
25		175.75	23.3	28.1	28.5°
26		140.00	7.1	9.0	36.0°
27		112.5	7.0	8.6	35.0°
28		112.5	16.1	19.2	27.0°
29		90.0	6.8	8.3	34.0°
30		69.0	6.8	8.1	31.5°

- l Distance forward of main step at keel and parallel to keel datum.
- l' Distance forward of rear step and parallel to keel datum.
- b Horizontal distance from keel to pressure pick-up.
- c Distance from keel to pick-up along keel-chine line.
- ∅L Local Deadrise.

FIG. I.

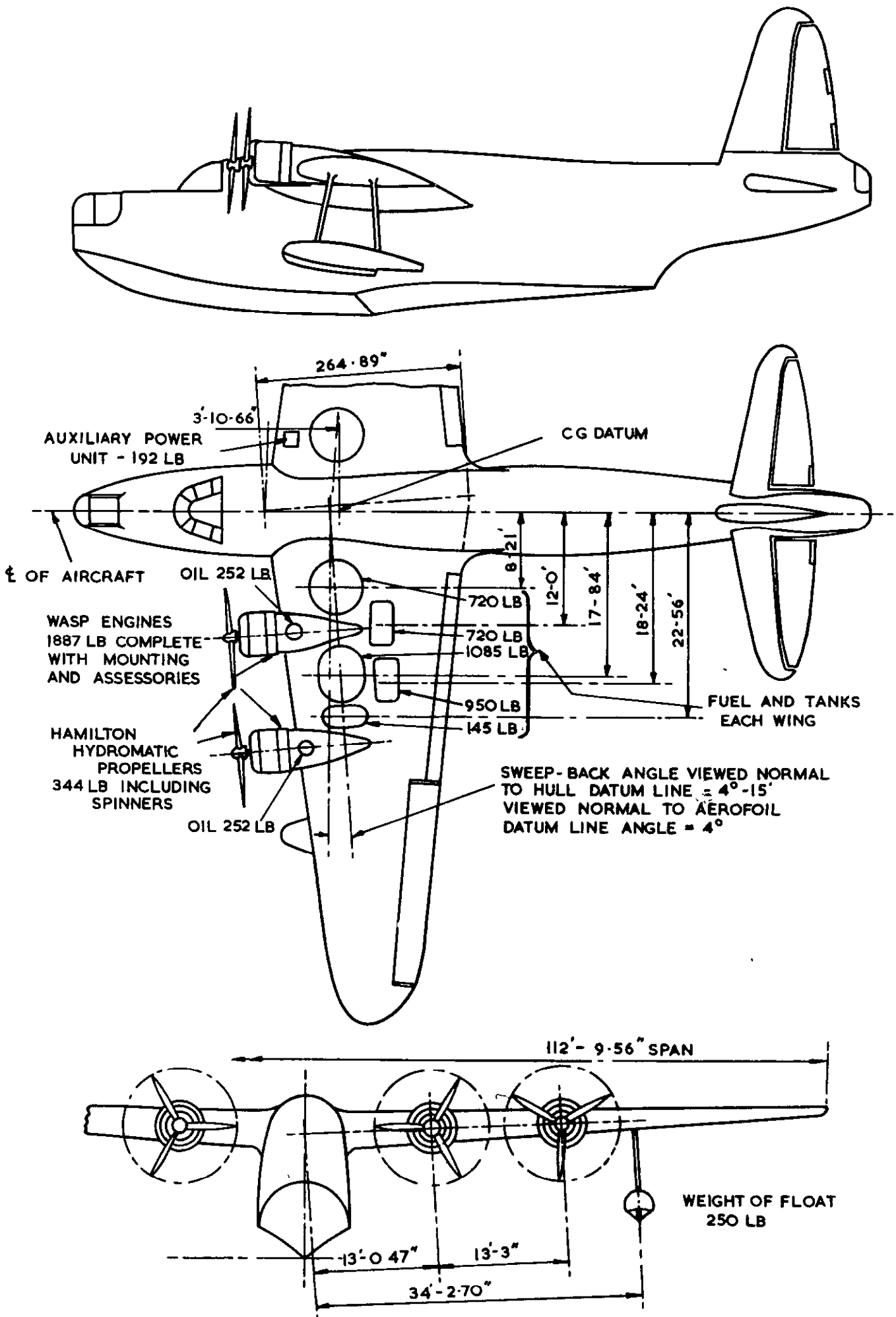

SUNDERLAND MK.V FLYING BOAT
GENERAL ARRANGEMENT AND POSITIONS OF MASSES IN WINGS.

FIG. 2.

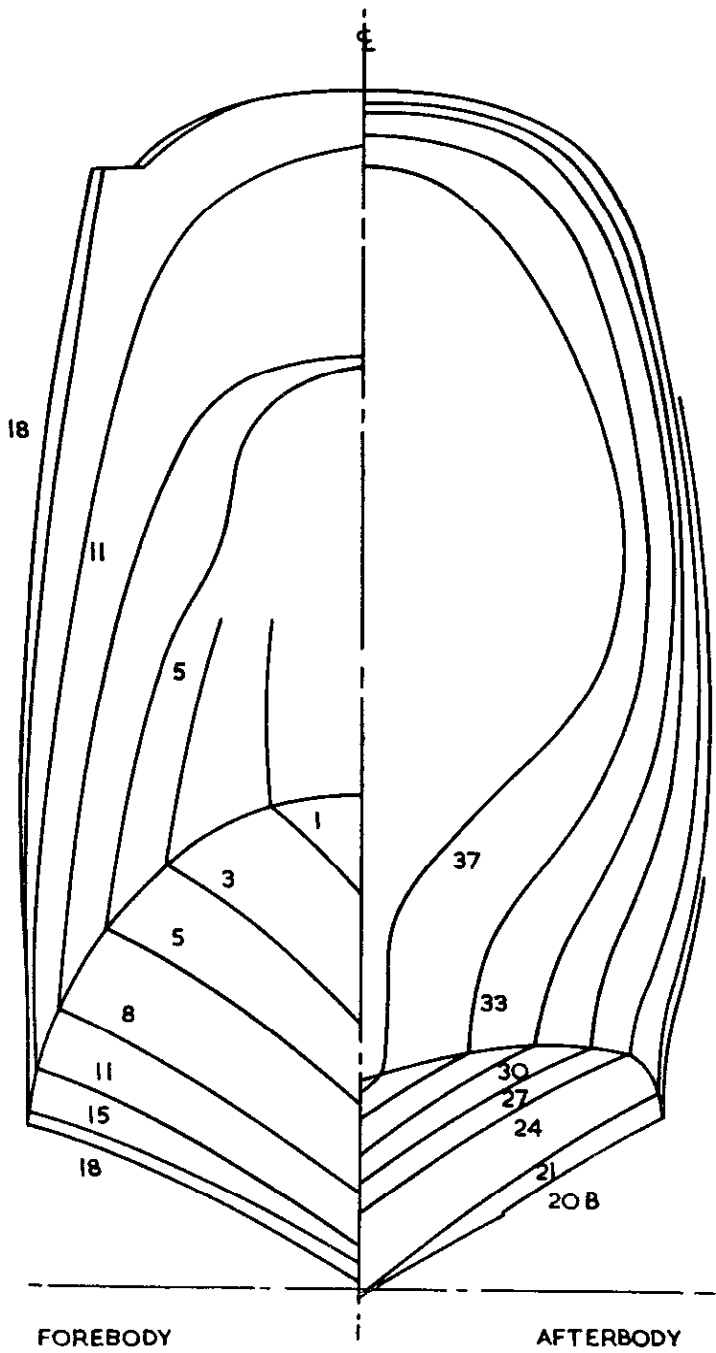
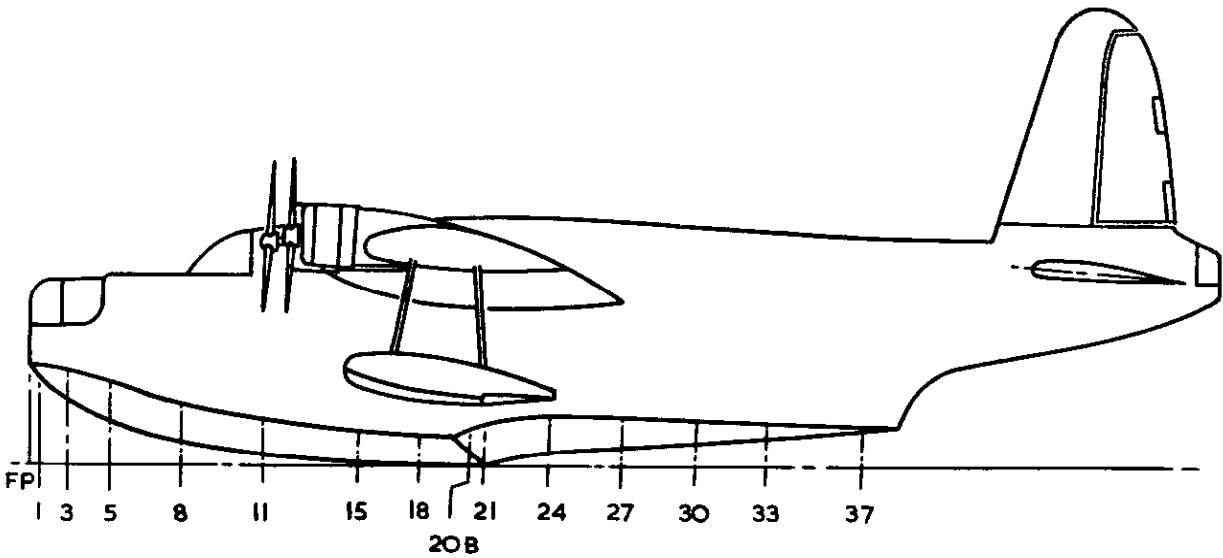

SUNDERLAND MK V HULL LINES

FIG. 3.

VIEW IN DIRECTION OF ARROW "X"
SHOWING PRESSURE PICK-UP
POSITIONS FORWARD OF REAR STEP.

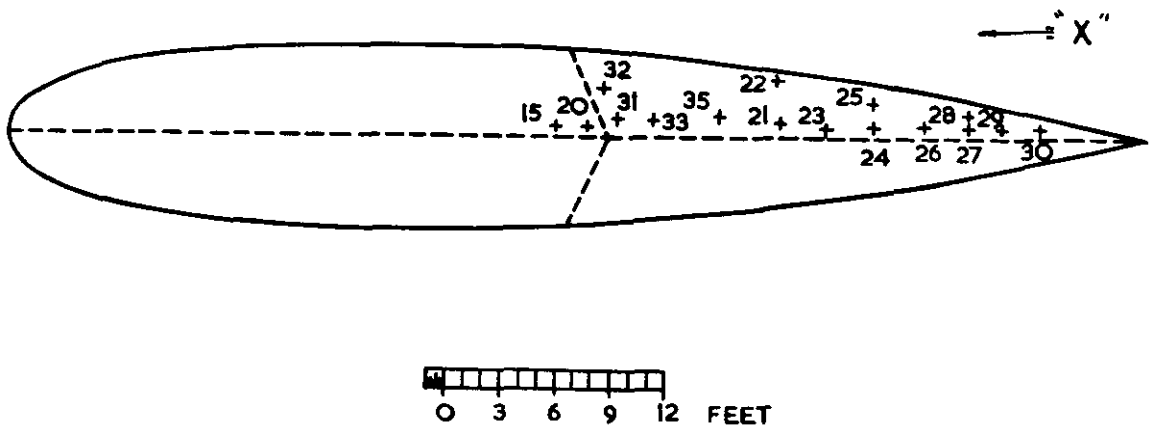
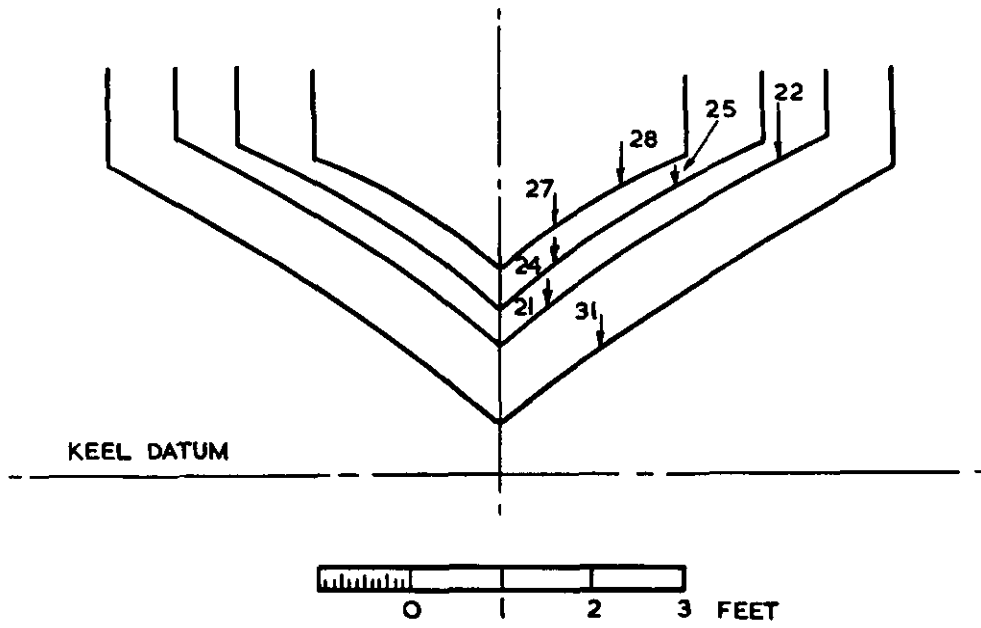

POSITIONS OF PRESSURE PICK-UPS USED.

FIG. 4.

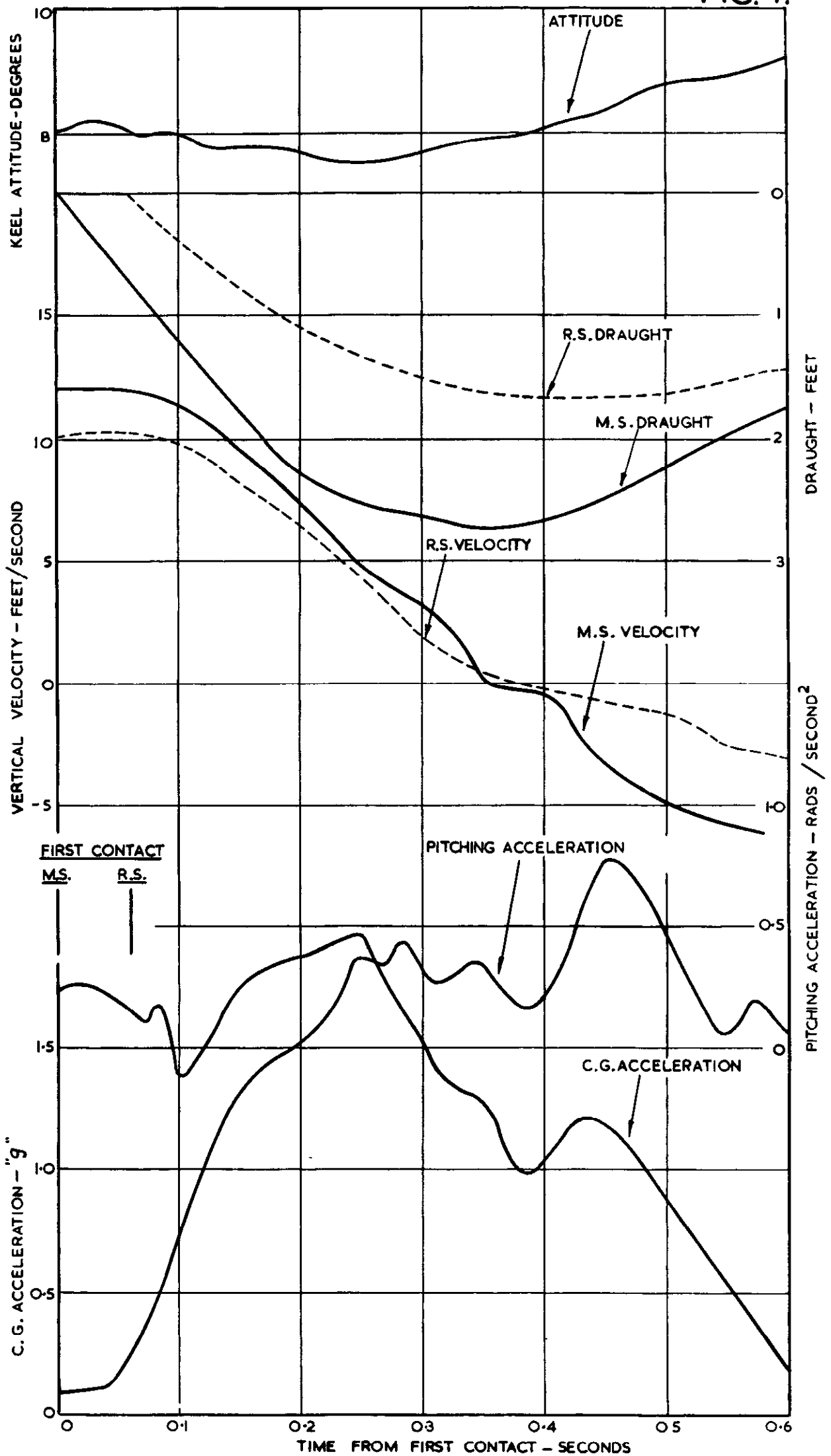

TOTAL IMPACT RESULTS FOR RUN No 11/5-2-52. $V_H = 107$ F.P.S.

FIG.4A.

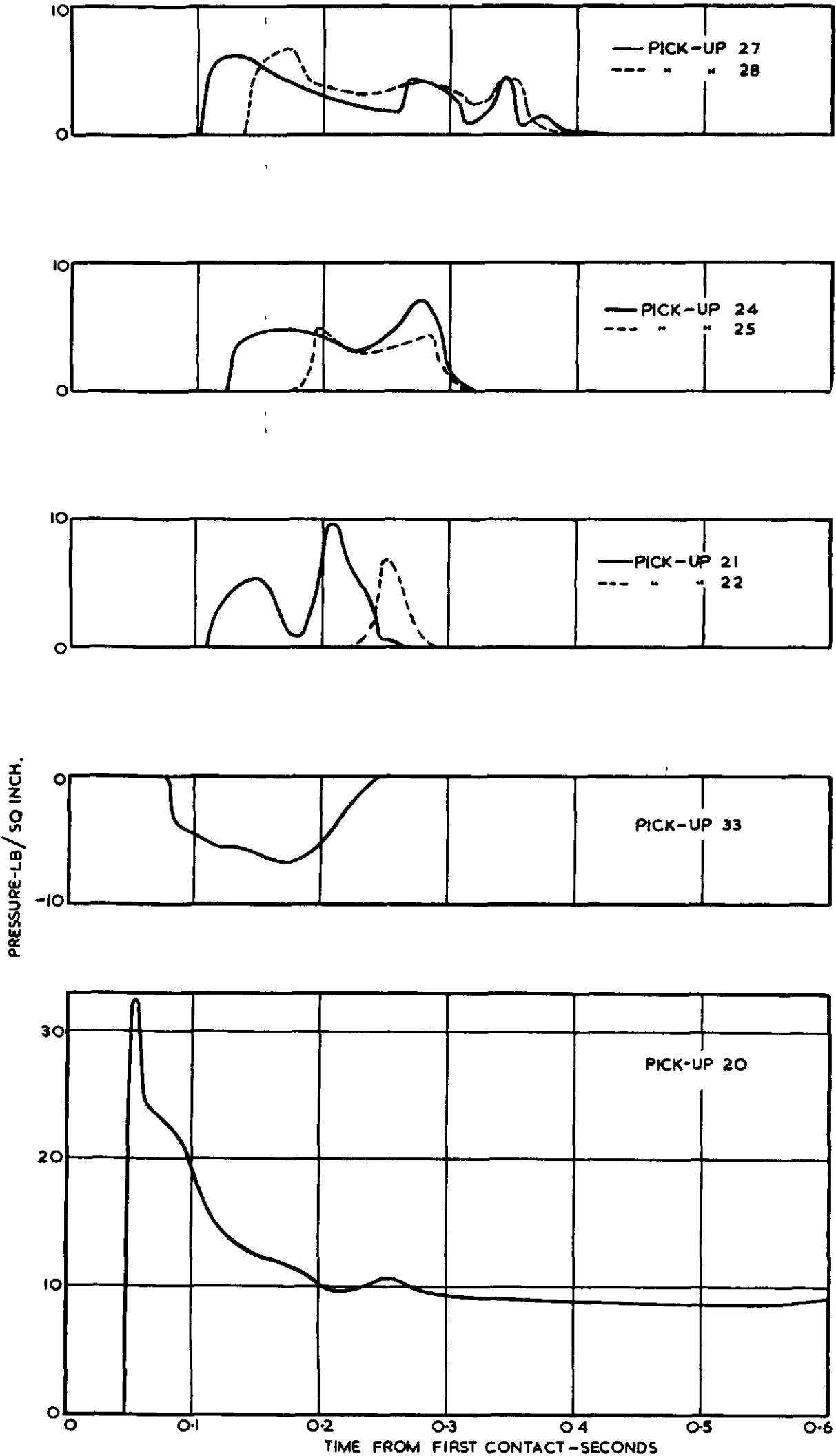

PRESSURE RESULTS FOR RUN NO 11/5-2-52.

FIG.5.

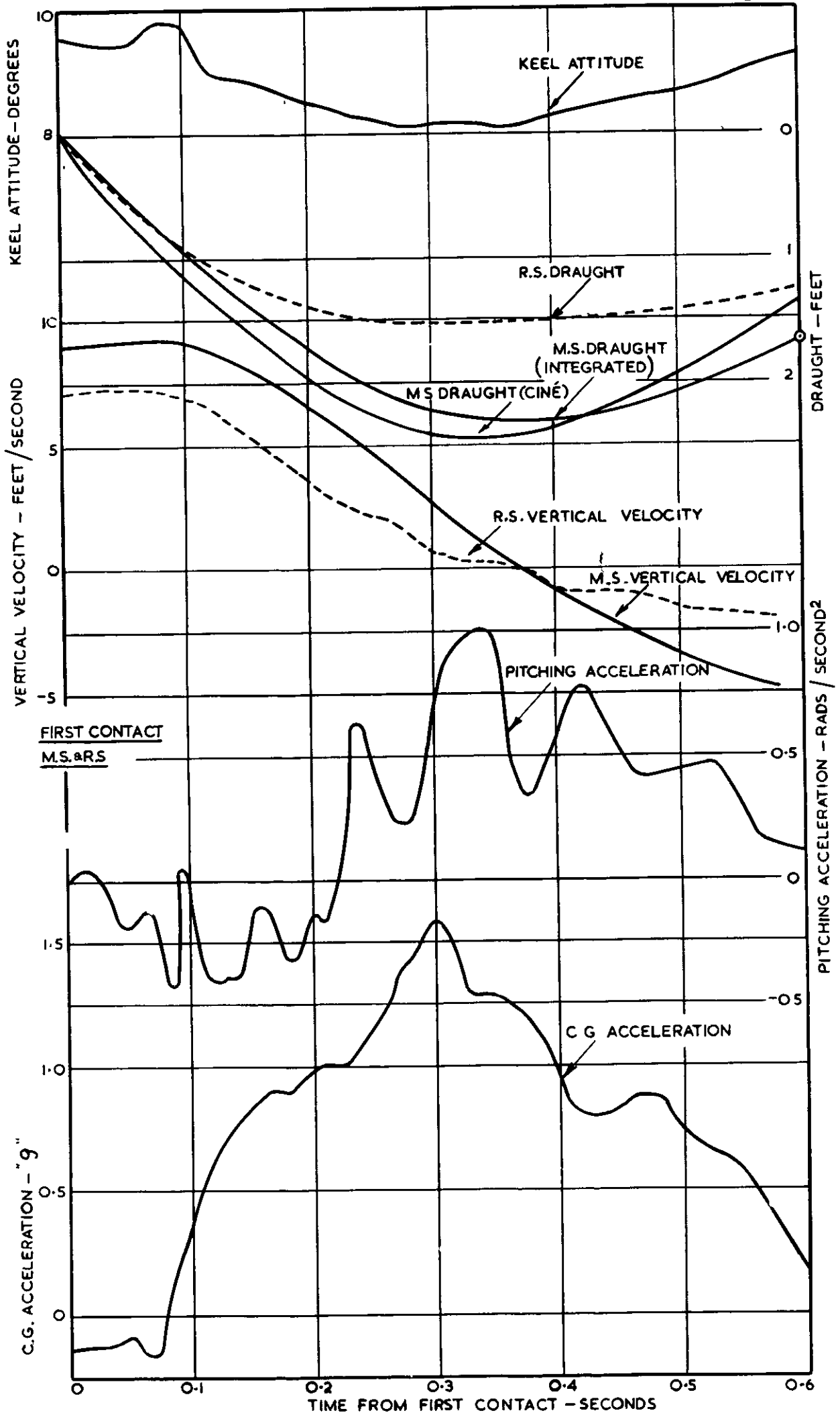

TOTAL IMPACT RESULTS FOR RUN NO 4/11-2-52 $V_H = 125$ FPS

FIG.5A.

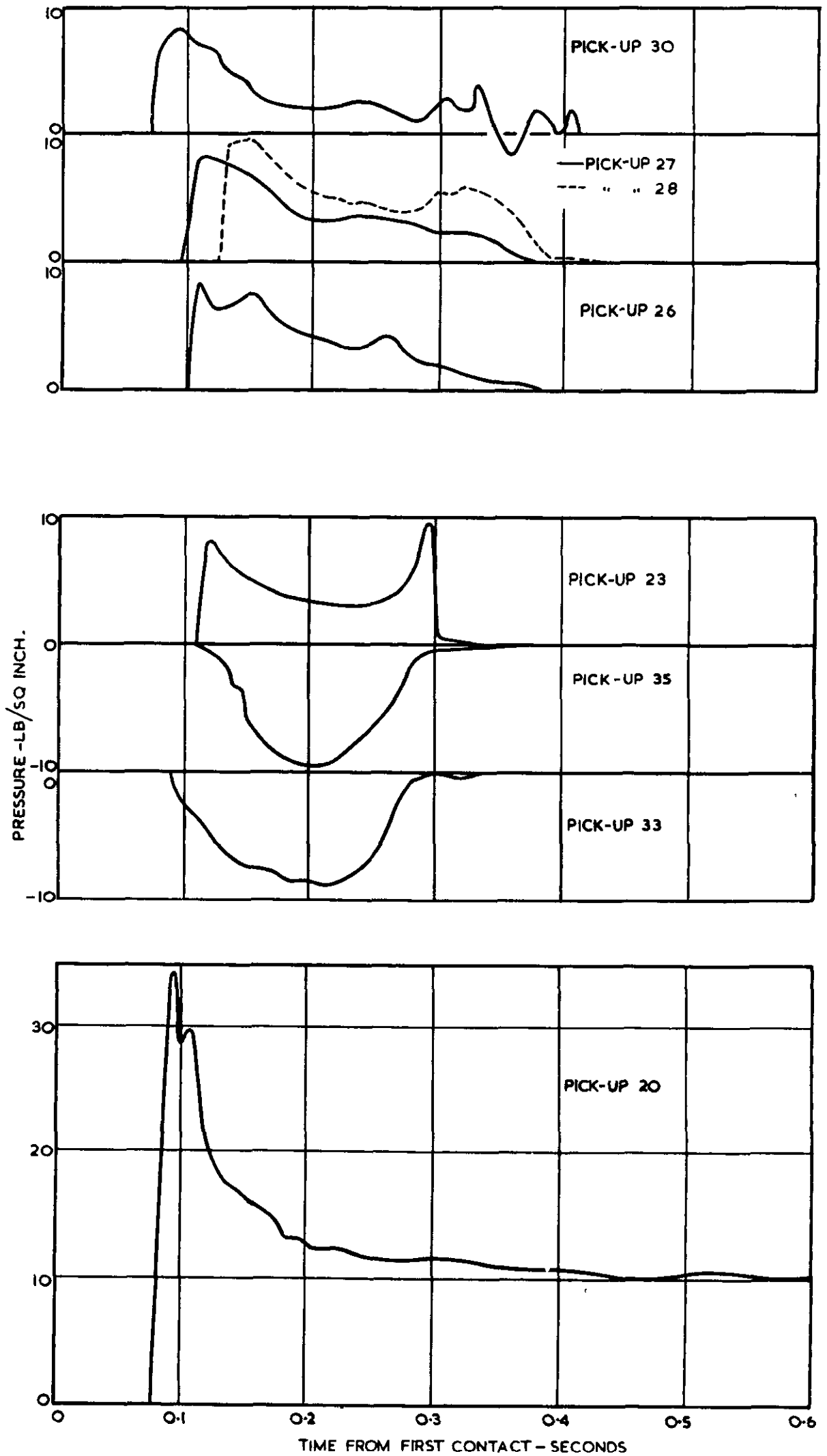

PRESSURE RESULTS FOR RUN NO 4 / 11-2-52.

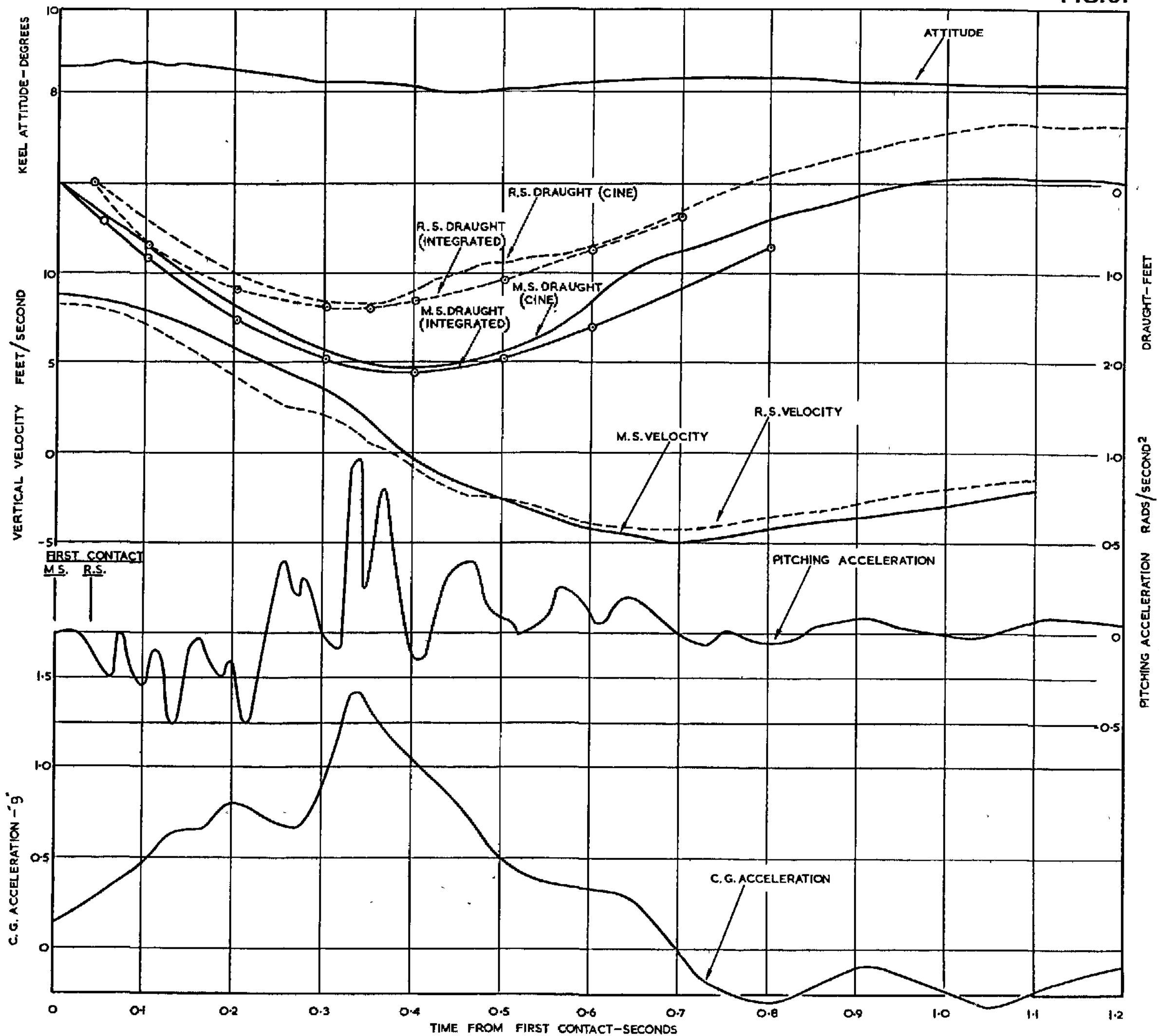

TOTAL IMPACT RESULTS FOR RUN N° 13 / 5-2-52. $V_H = 117$ F.P.S.

FIG. 6 A.

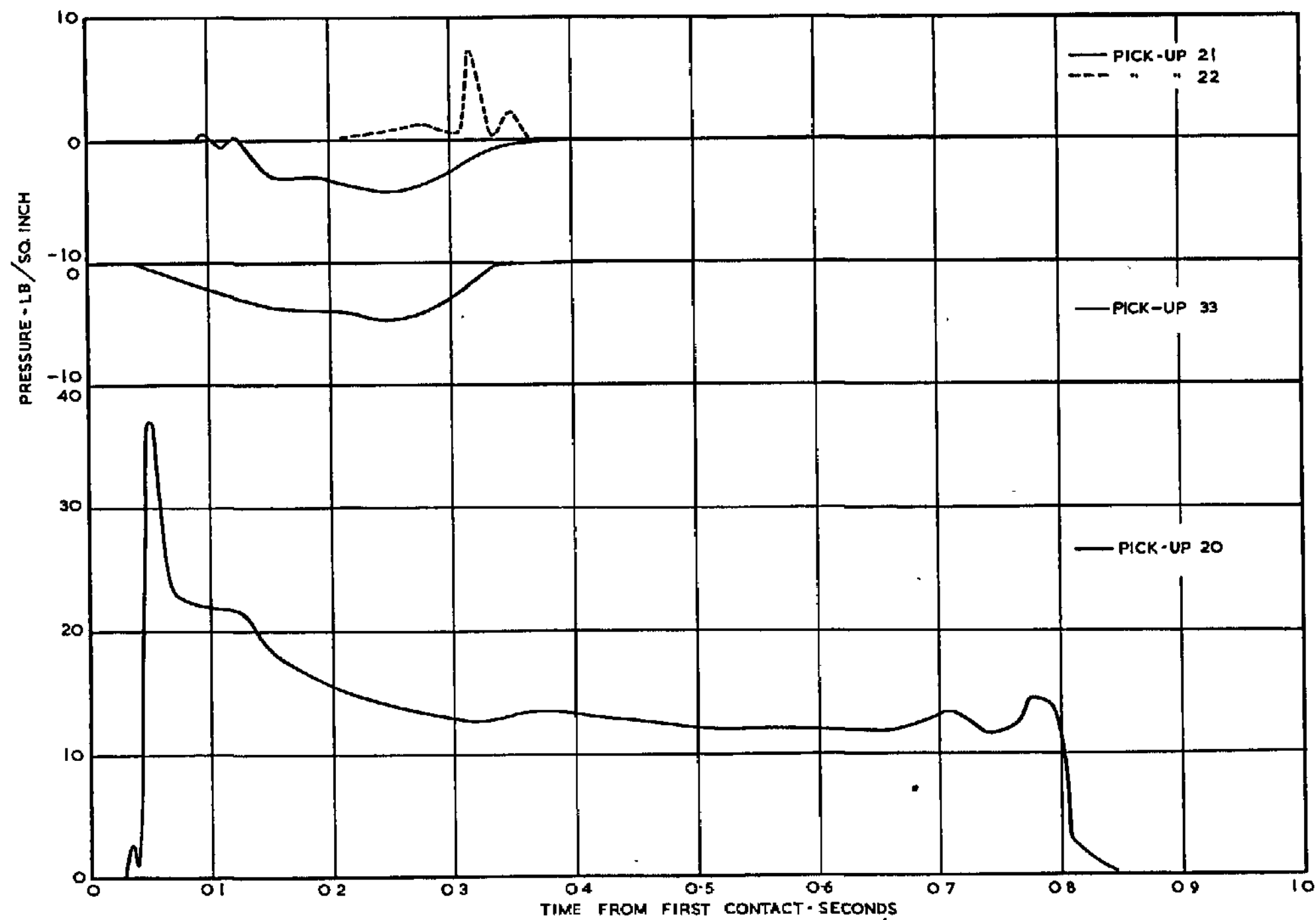
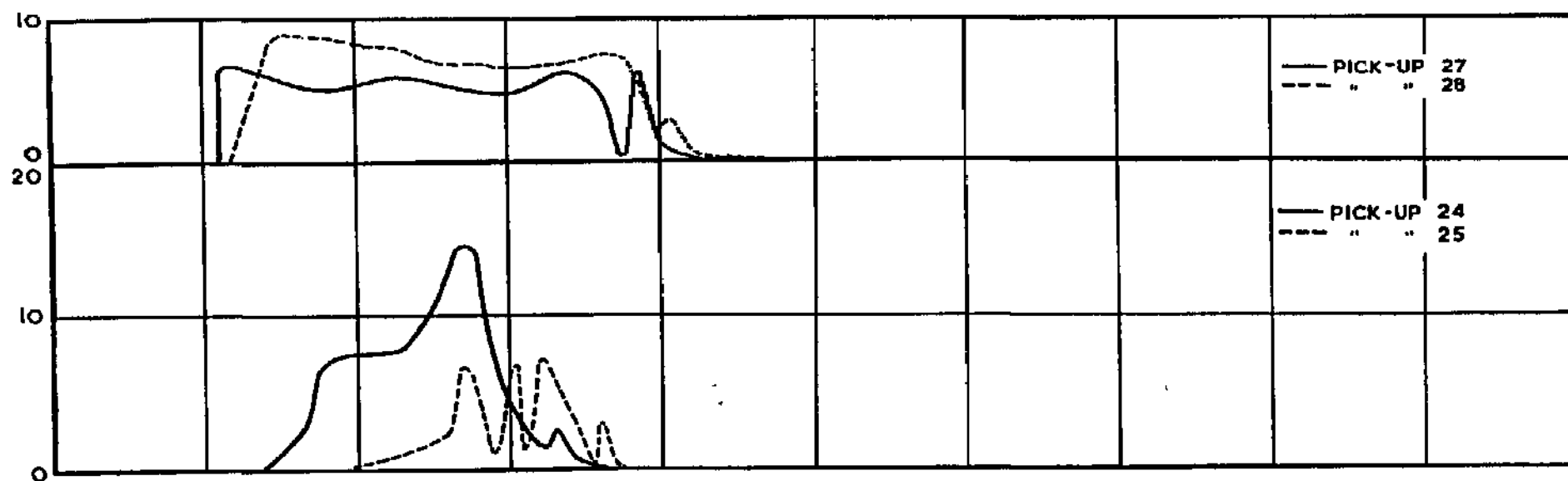

PRESSURE RESULTS FOR RUN N^o 13./5-2-52.

FIG. 7.

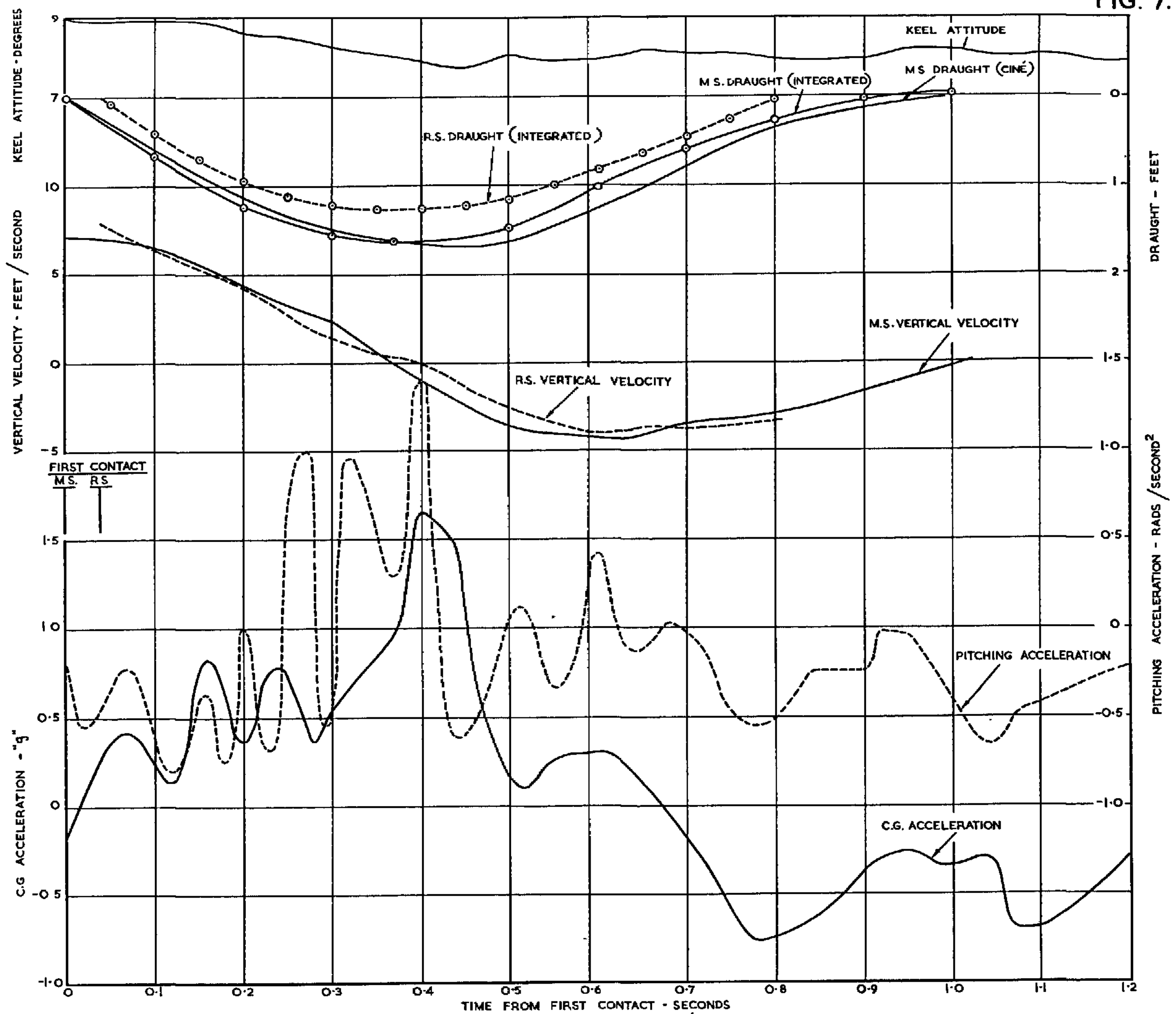

TOTAL IMPACT RESULTS FOR RUN N° 4. / 8-8-51. $V_H = 125$ F.P.S.

FIG.7A.

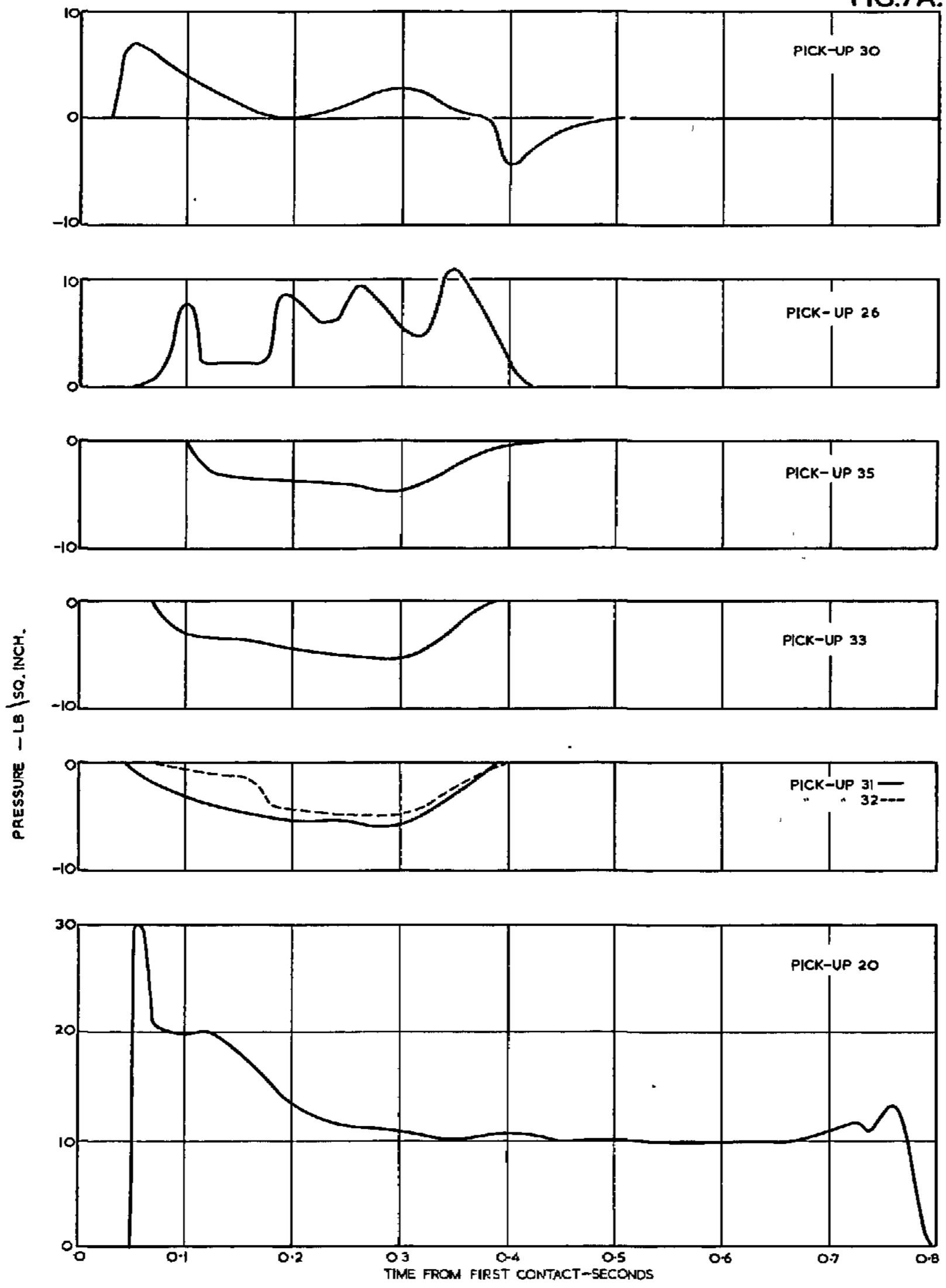

PRESSURE RESULTS FOR RUN N°4 / 8-8-51.

FIG. 8.

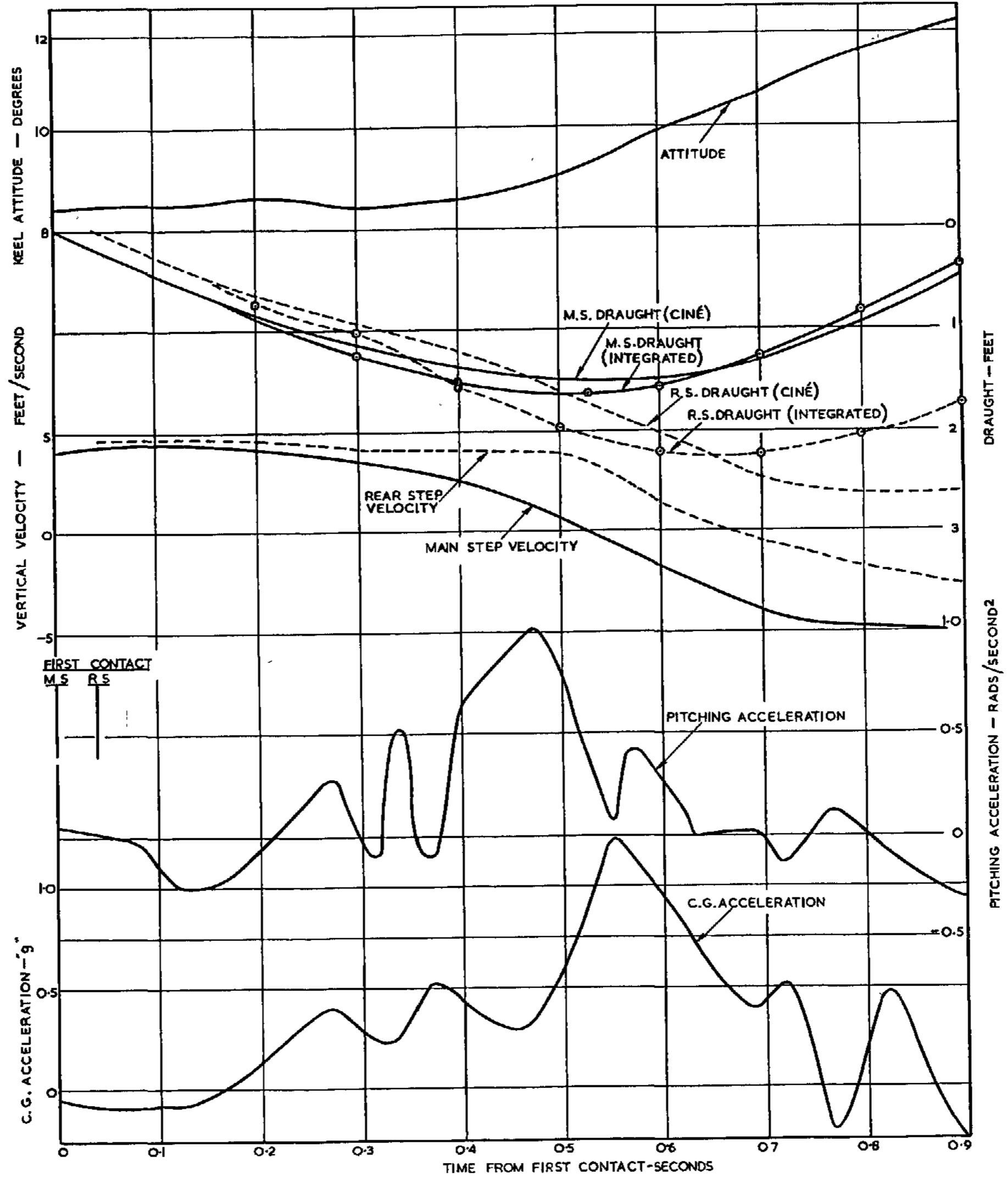

TOTAL IMPACT RESULTS FOR RUN N^o2/8-8-51. FIRST IMPACT $V_H=122$ F.P.S

FIG.8A.

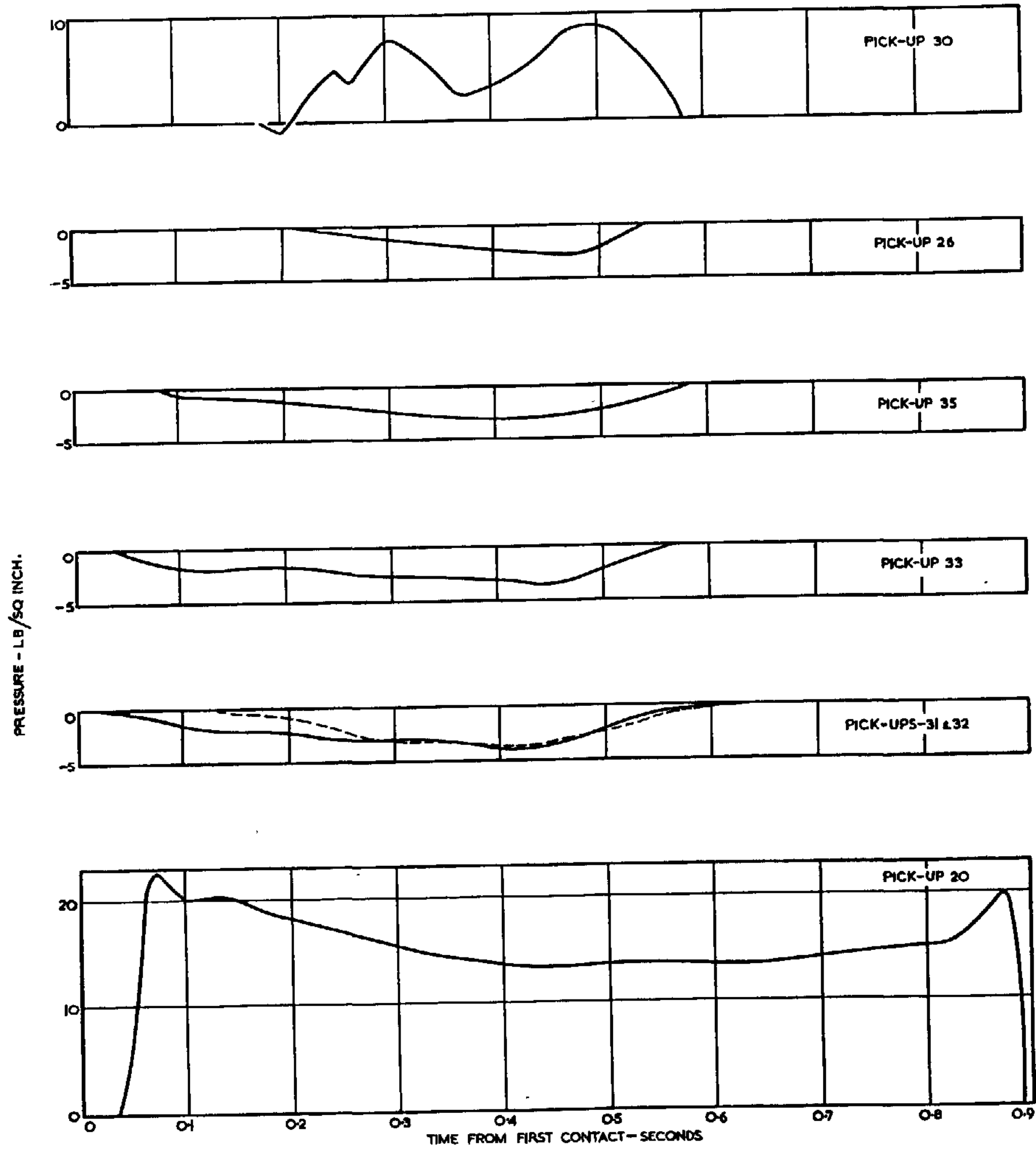

PRESSURE RESULTS FOR RUN N^o 2/8-B-51 FIRST IMPACT.

TOTAL IMPACT RESULTS FOR RUN No 2/8-8-51. SECOND IMPACT $V_H = 105$ F.P.S.

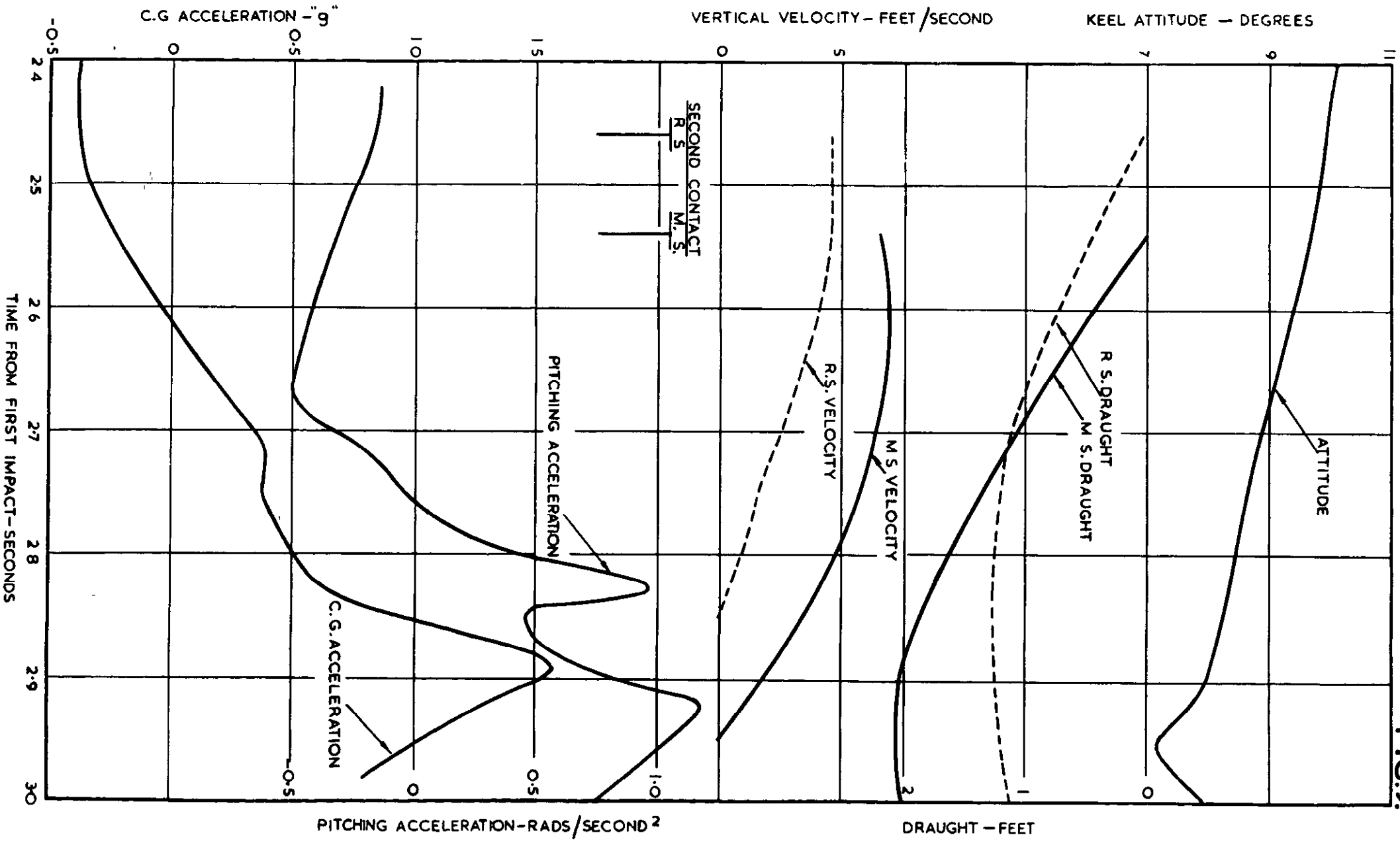
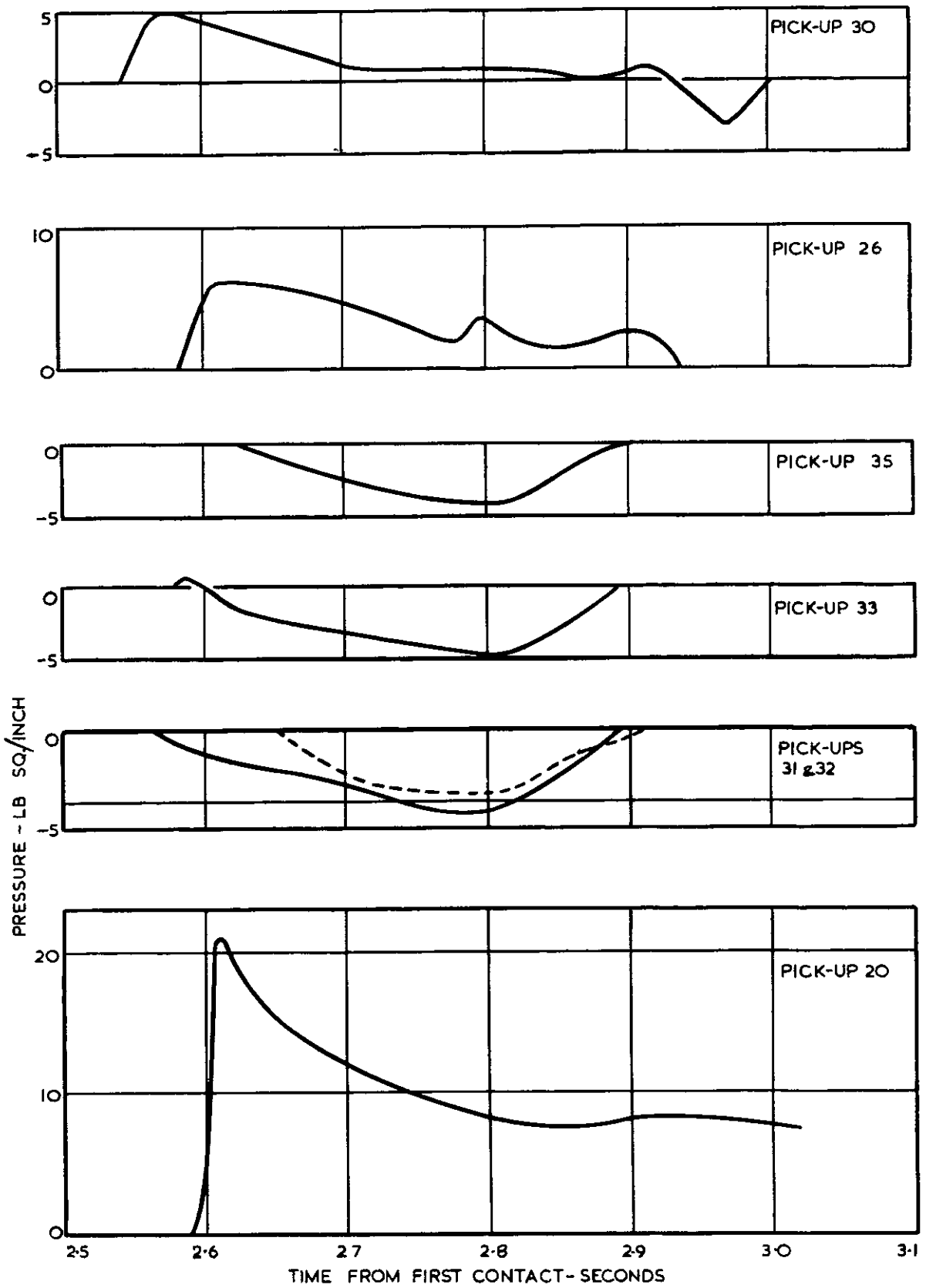

FIG. 9.

FIG. 9A.



PRESSURE RESULTS FOR RUN №2/8-8-51. SECOND IMPACT $V_H = 105$ FPS.

FIG.10.

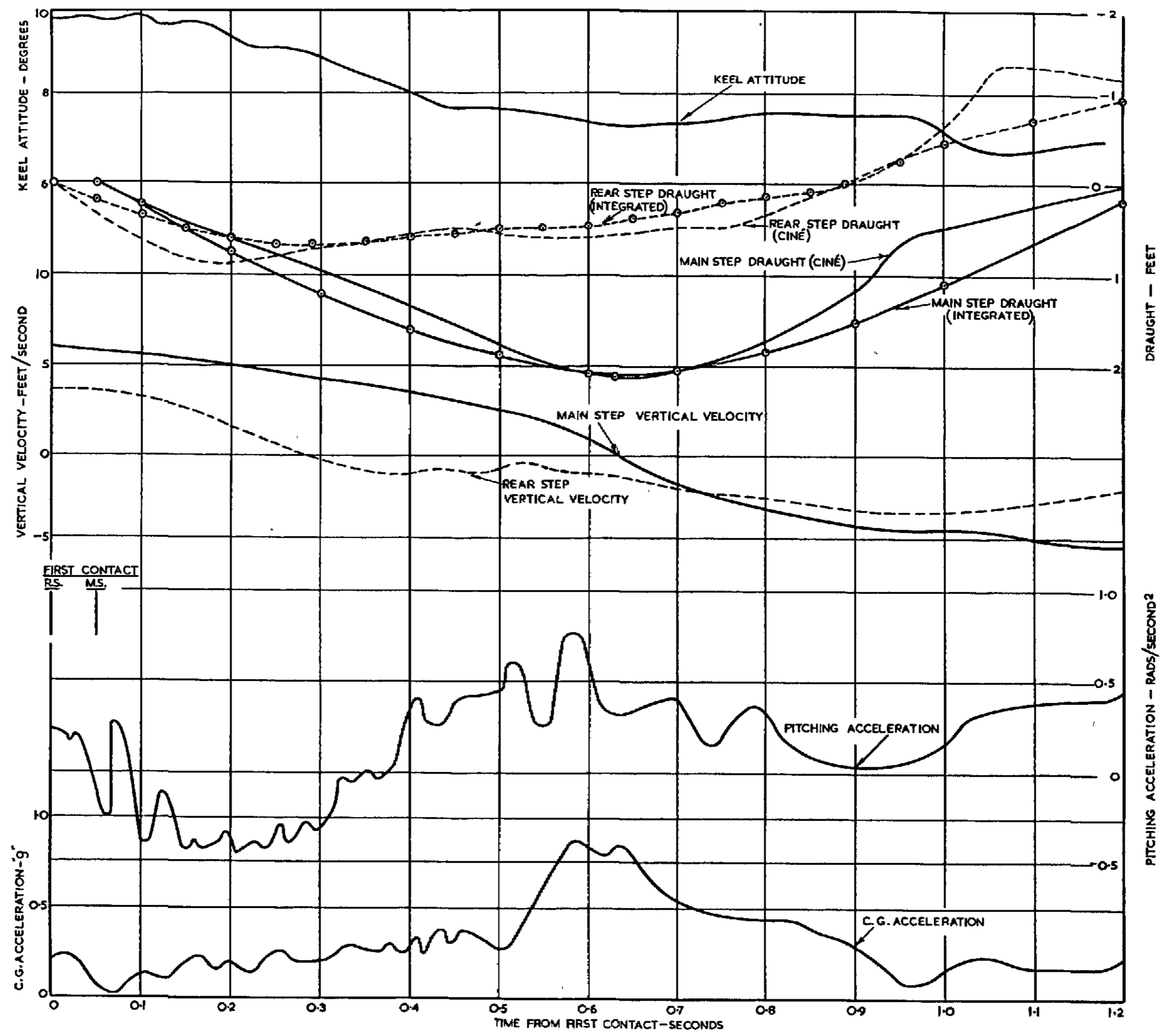

TOTAL IMPACT RESULTS FOR RUN N^o11/29-1-52 V_H=128 FPS.

FIG. 10A.

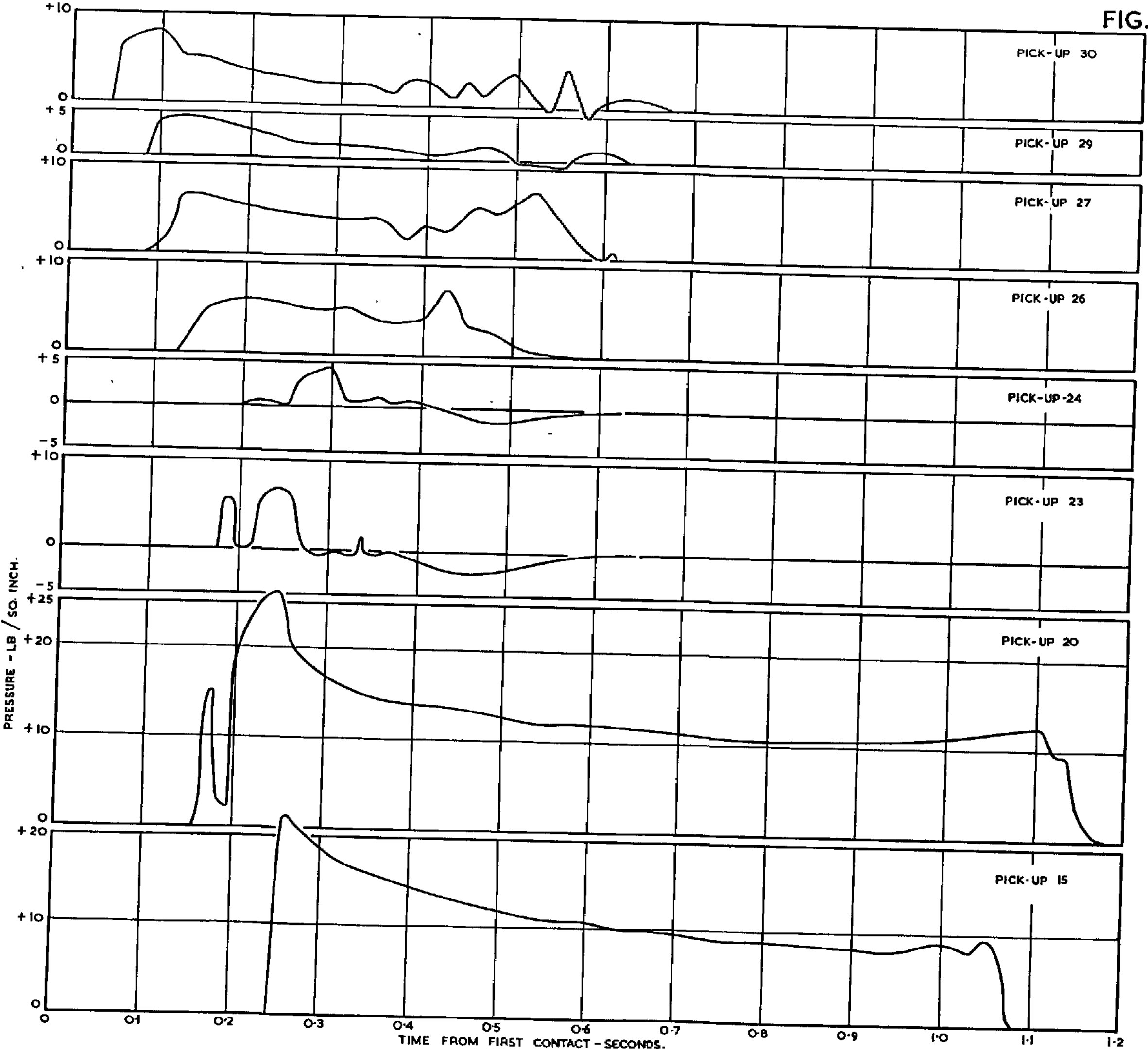

PRESSURE RESULTS FOR RUN NO 11 / 29-1-52.

FIG.II.

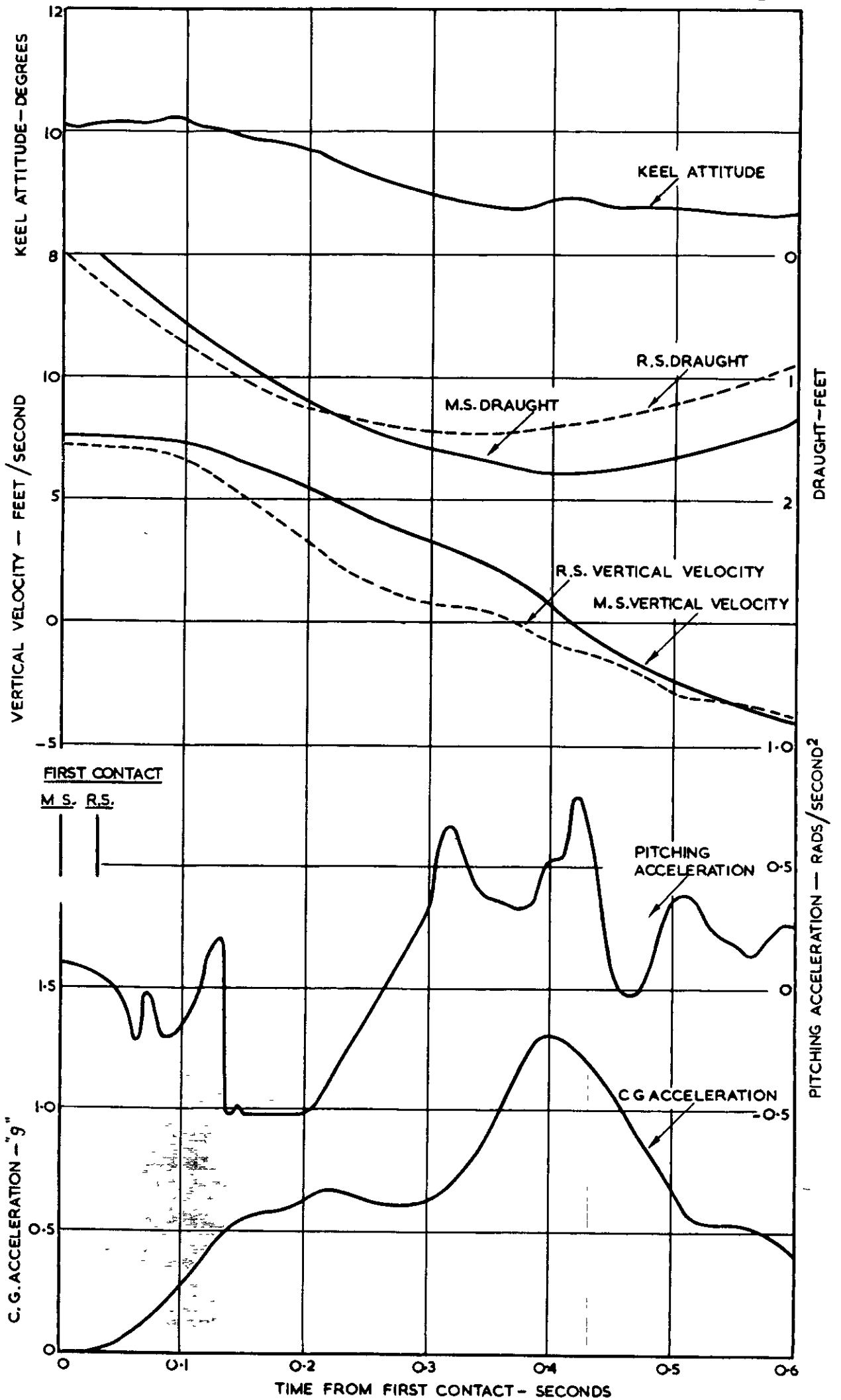

TOTAL IMPACT RESULTS FOR RUN NO 10/11-2-52 $V_H=147$ FPS

FIG.IIA.

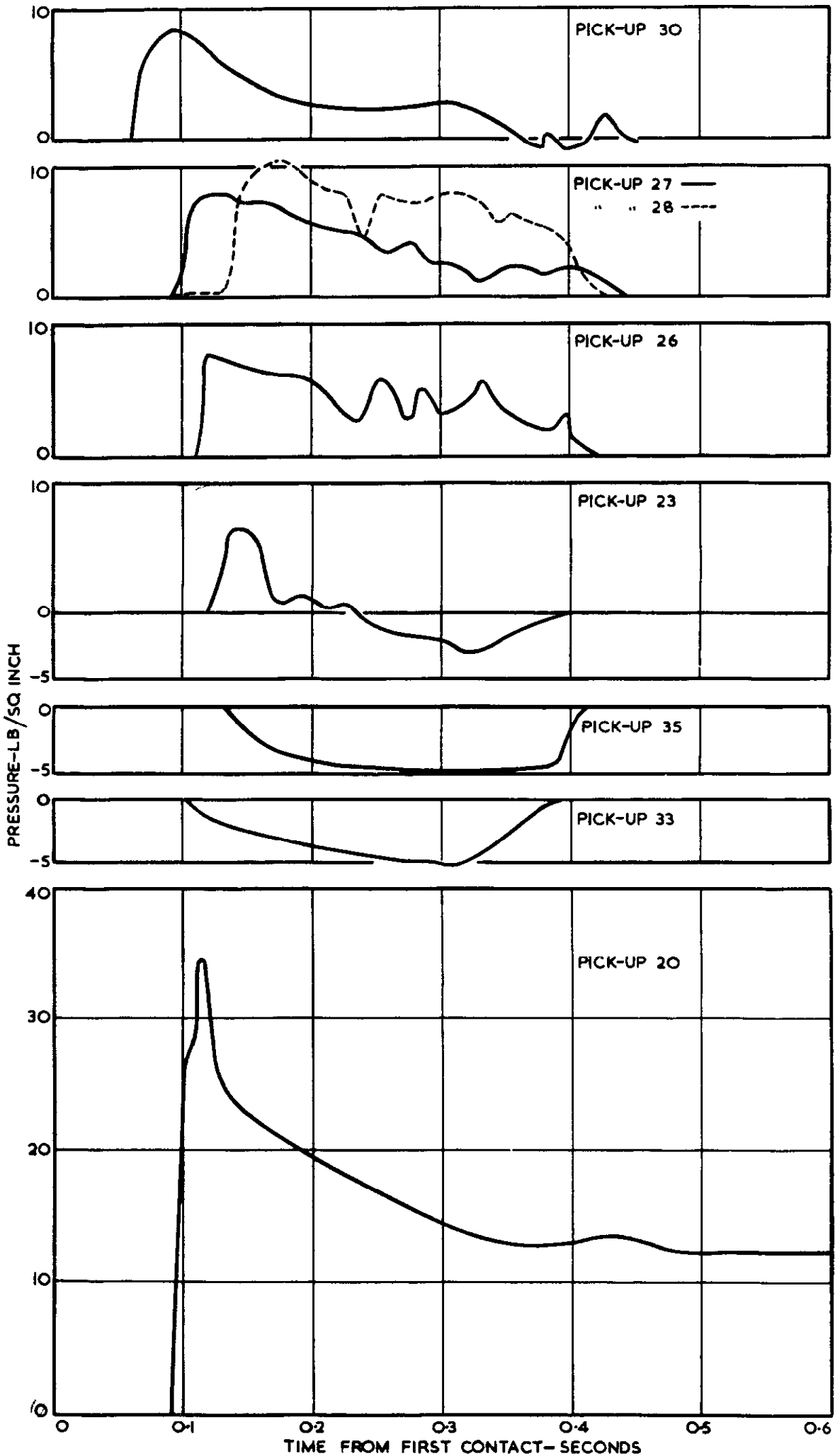

PRESSURE RESULTS FOR RUN N^o10/11-2-52.

FIG.12.

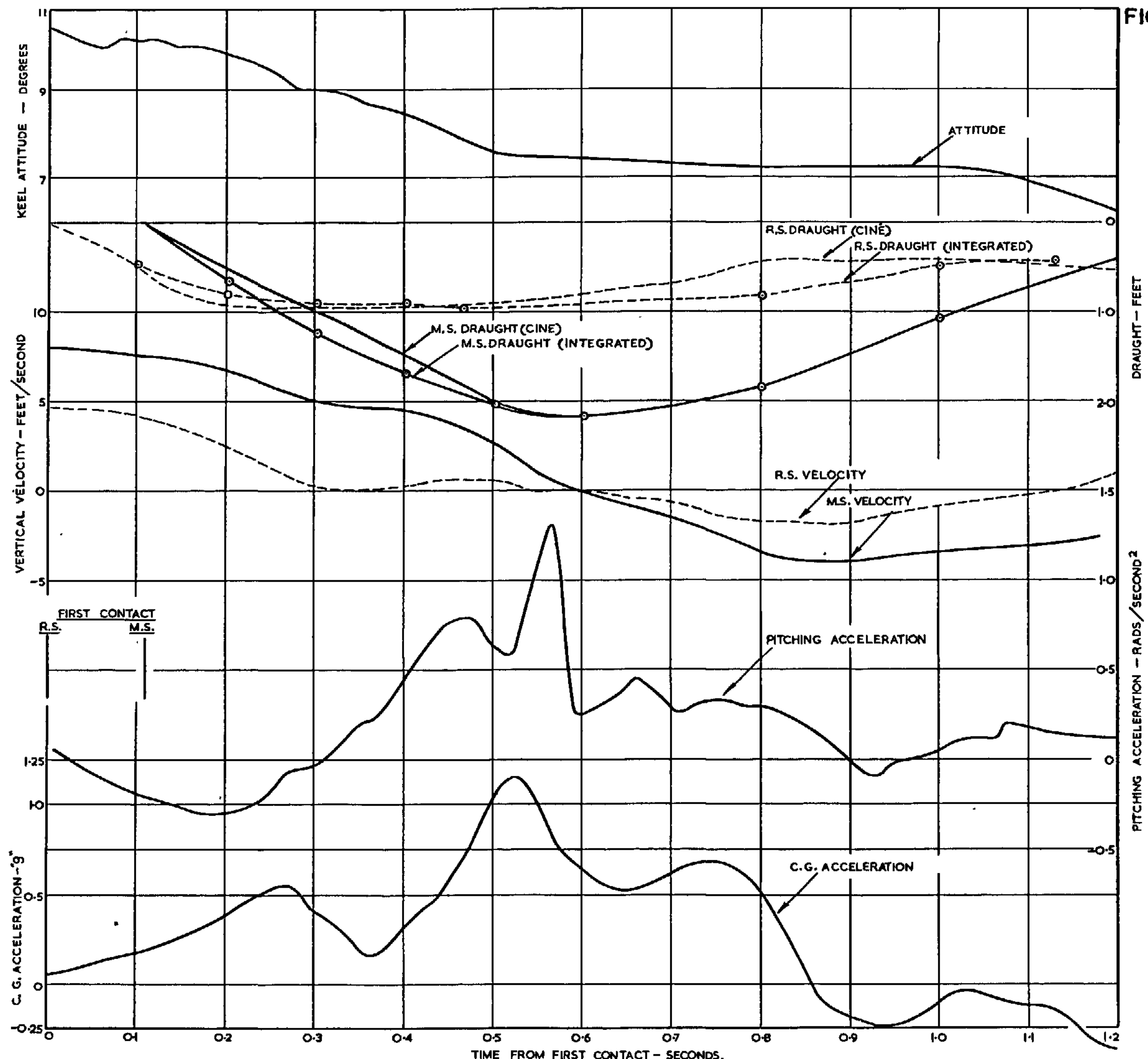

TOTAL IMPACT RESULTS FOR RUN N°13/29-1-52. $V_H = 103$ F.S.

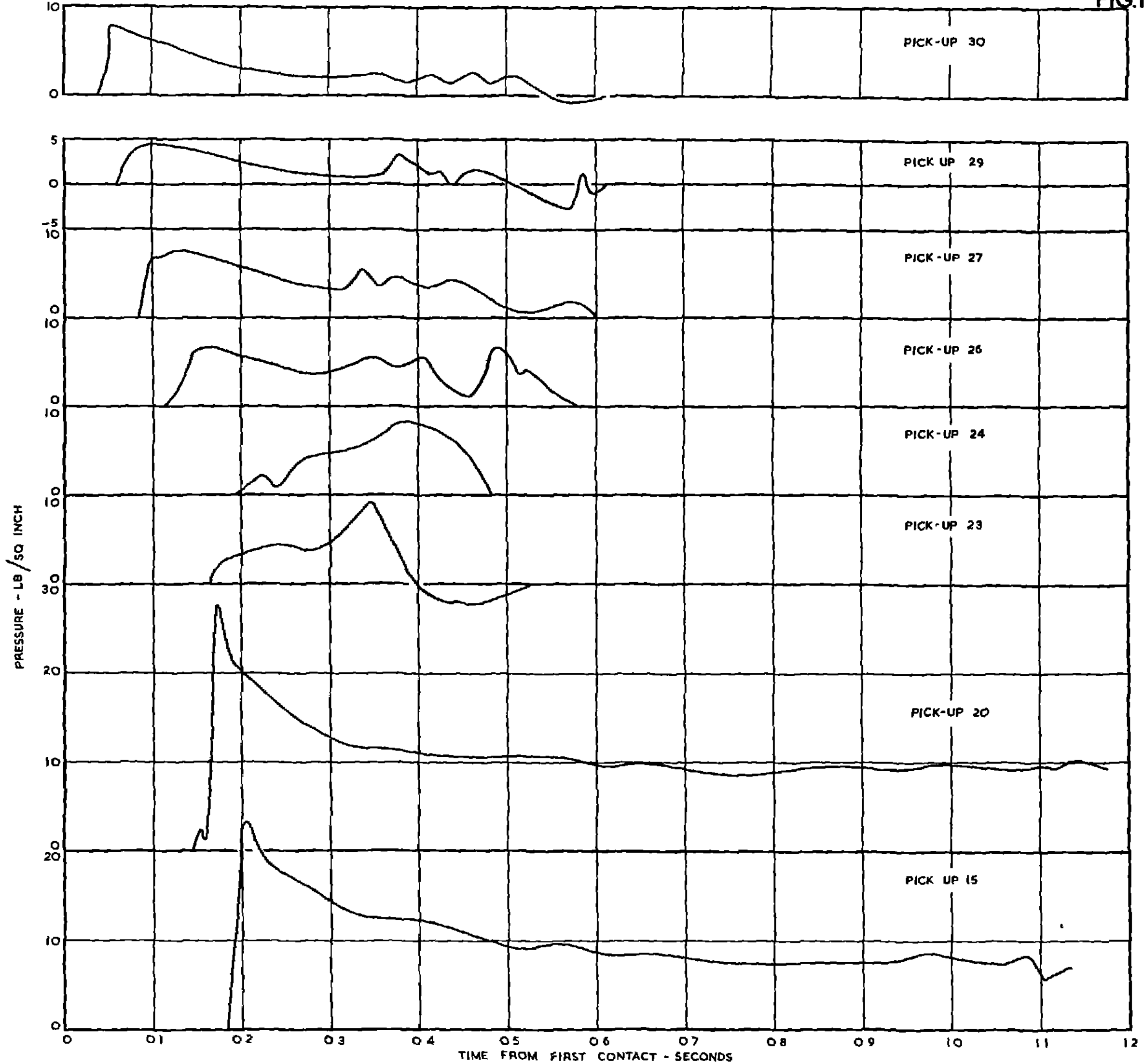

PRESSURE RESULTS FOR RUN N° 13 / 29-1-52

FIG.13.

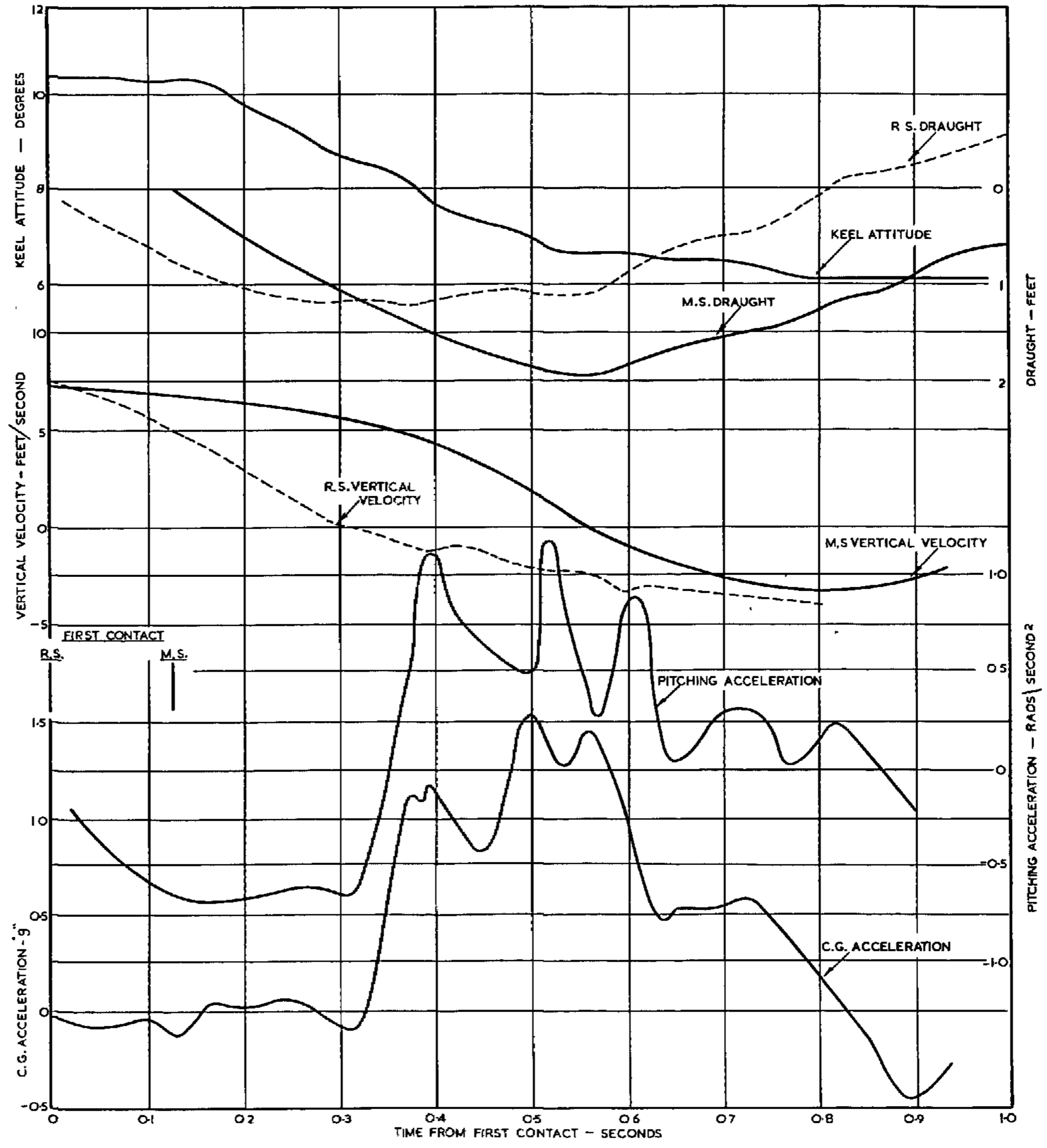

TOTAL IMPACT RESULTS FOR RUN NO 10 / 24-4-51. $V_H = 108$ F.P.S.

FIG. 13A.

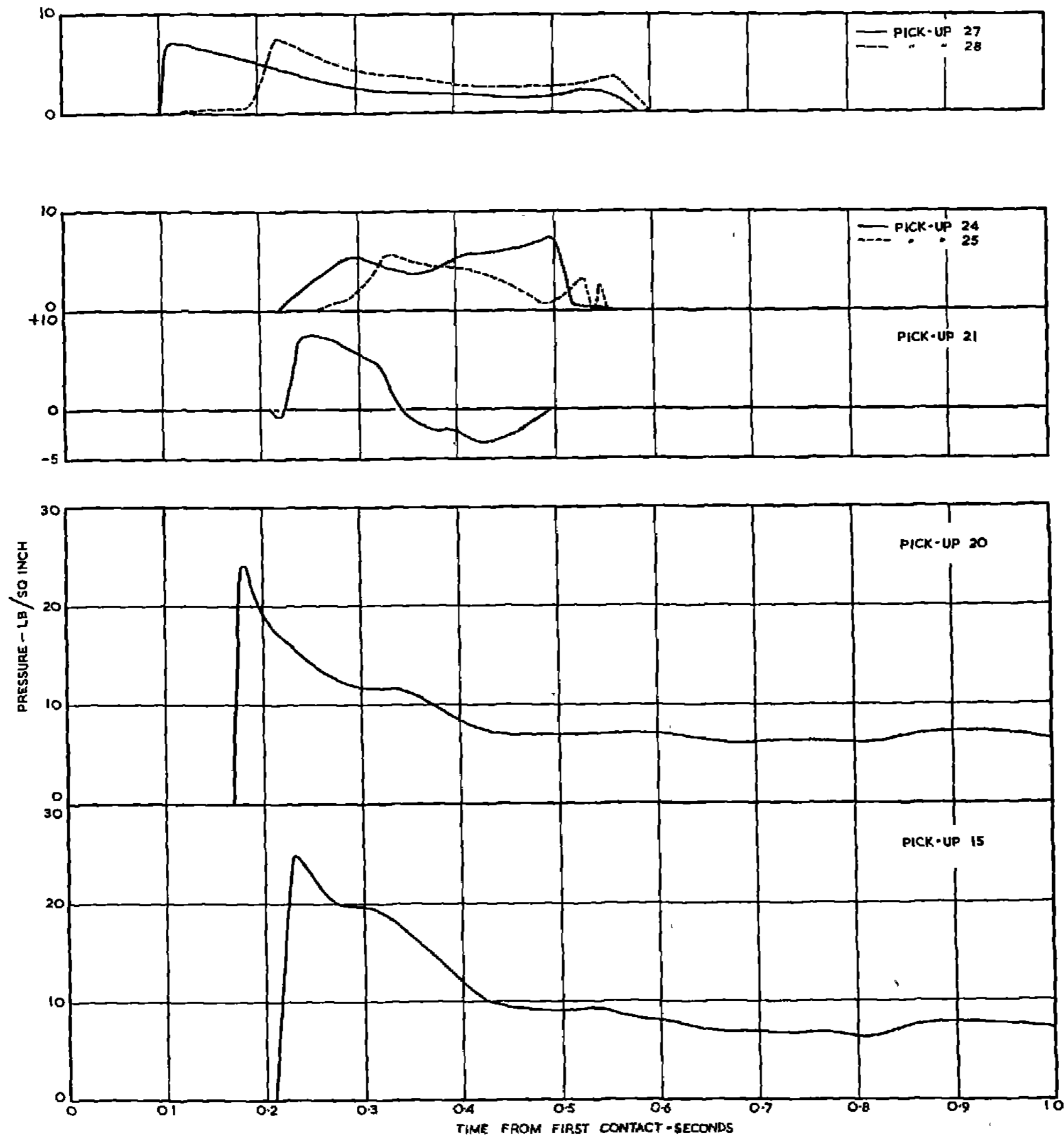

PRESSURE RESULTS FOR RUN N° 10 / 24-4-51.

FIG.14.

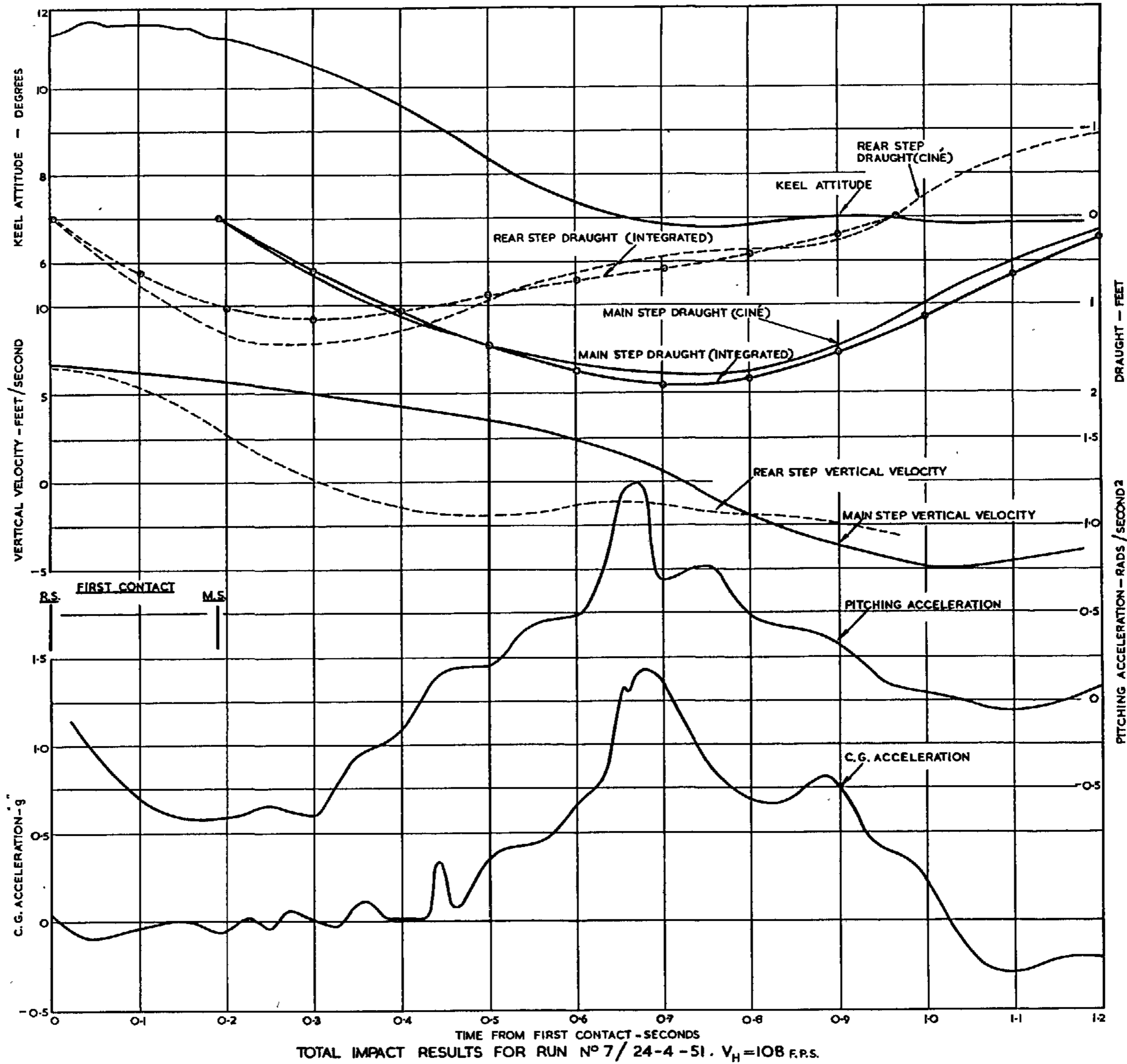

TOTAL IMPACT RESULTS FOR RUN N° 7 / 24-4-51. $V_H = 108$ F.P.S.

FIG. 14 A.

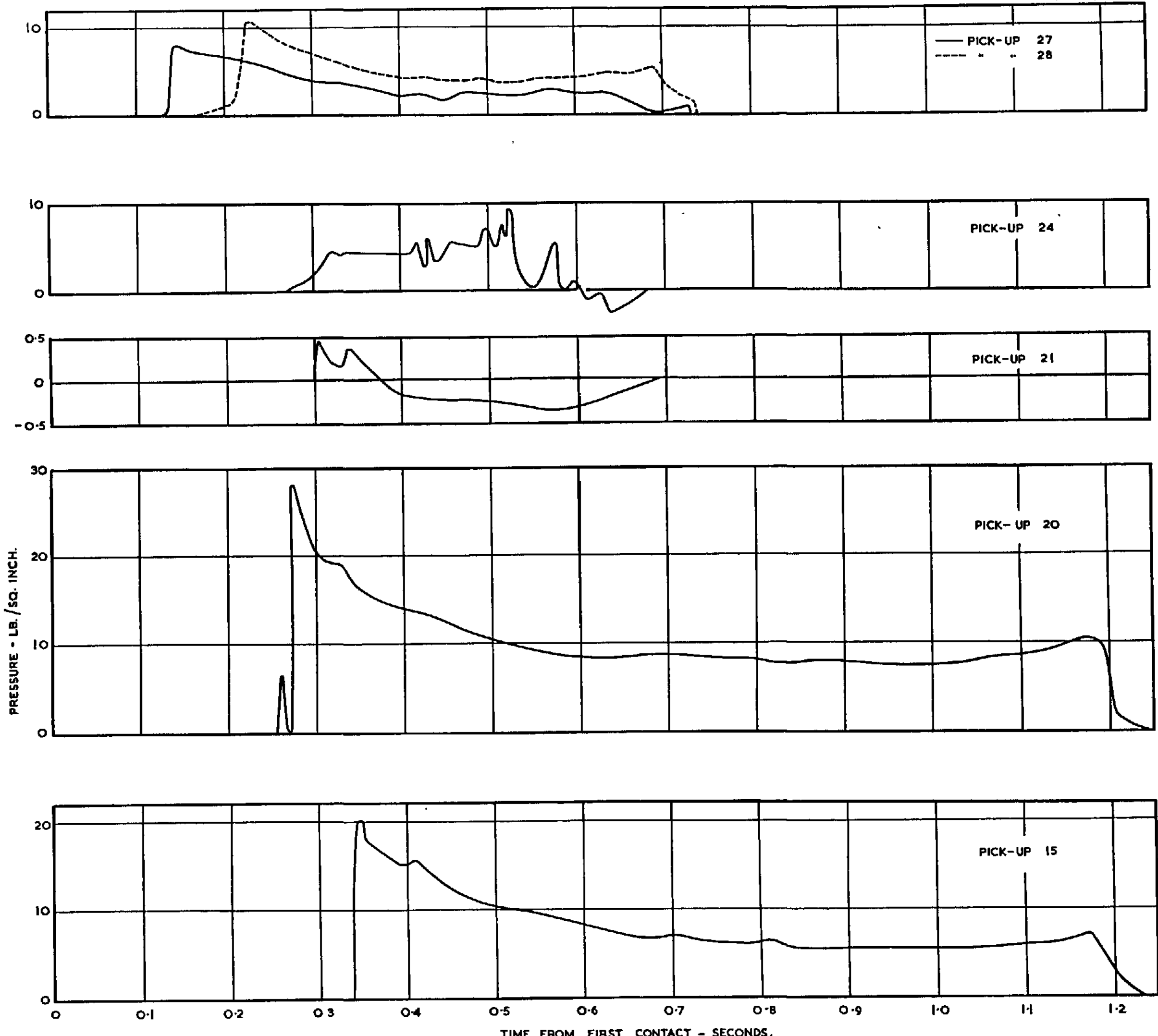

PRESSURE RESULTS FOR RUN N° 7 / 24-4-51.

FIG. 15.

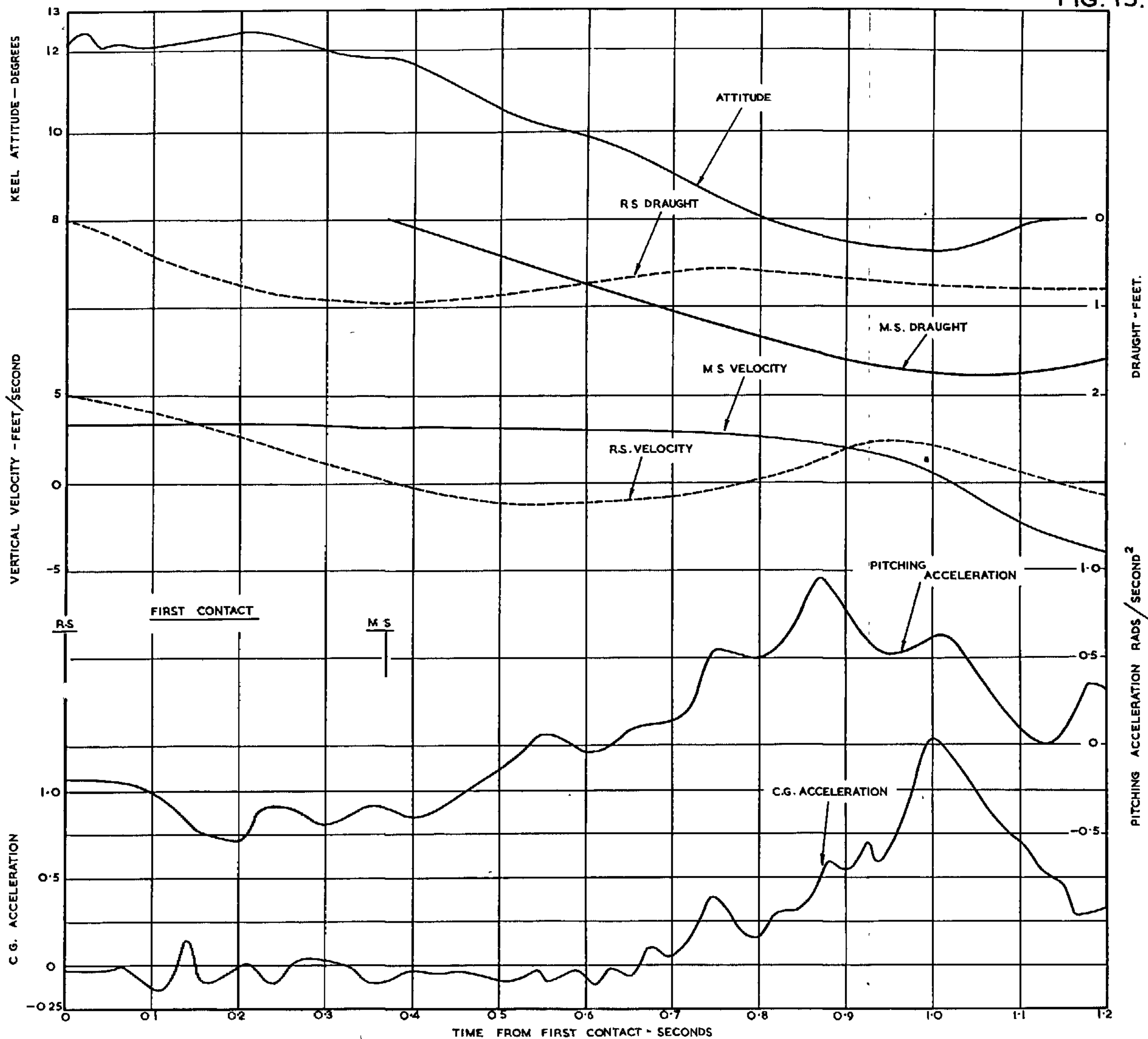

TOTAL IMPACT RESULTS FOR RUN NO 11/24-4-51. $V_H = 112$ F.P.S

FIG. 15A.

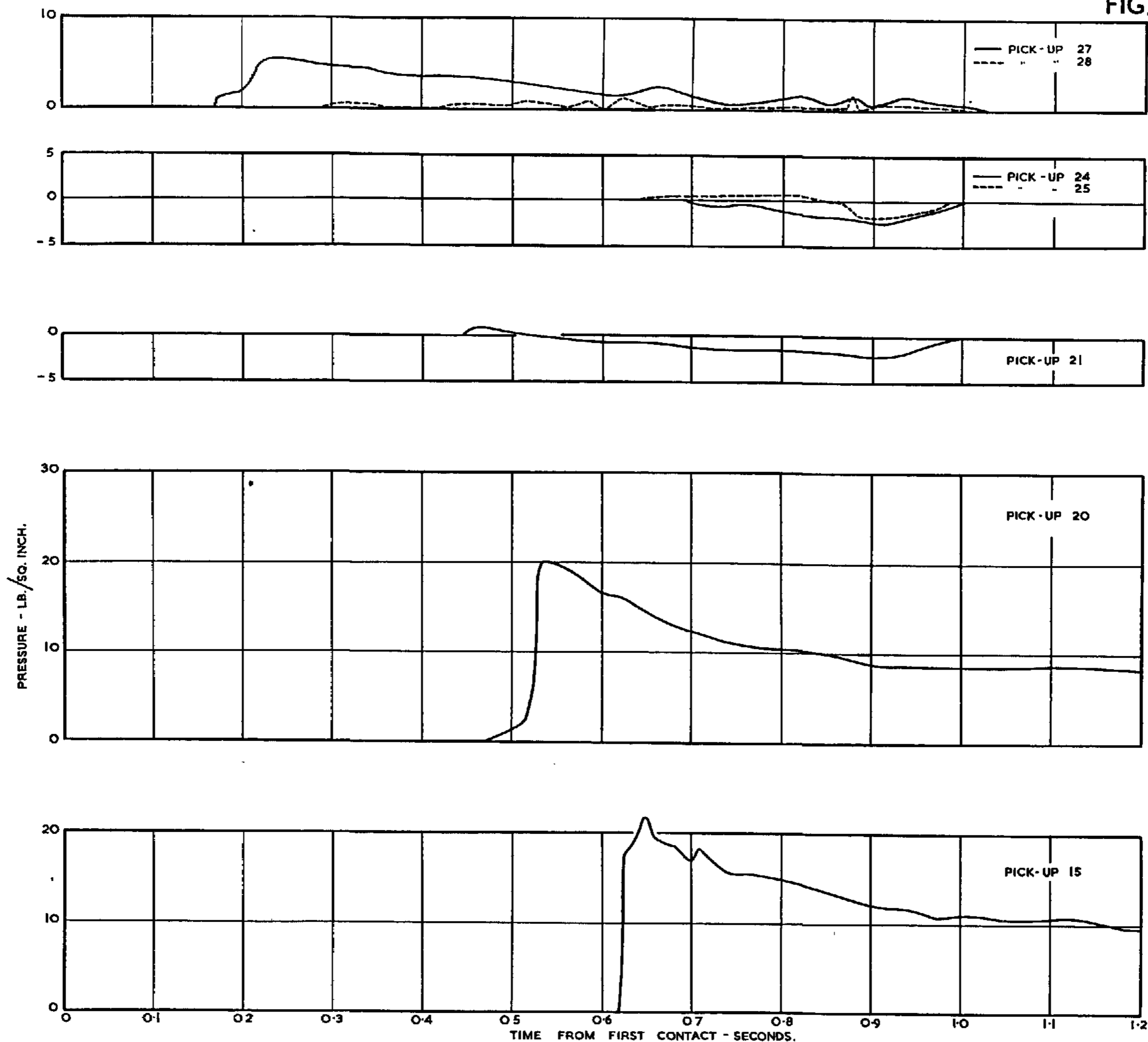

PRESSURE RESULTS FOR RUN N° II / 24-4-51.

FIG. 16.

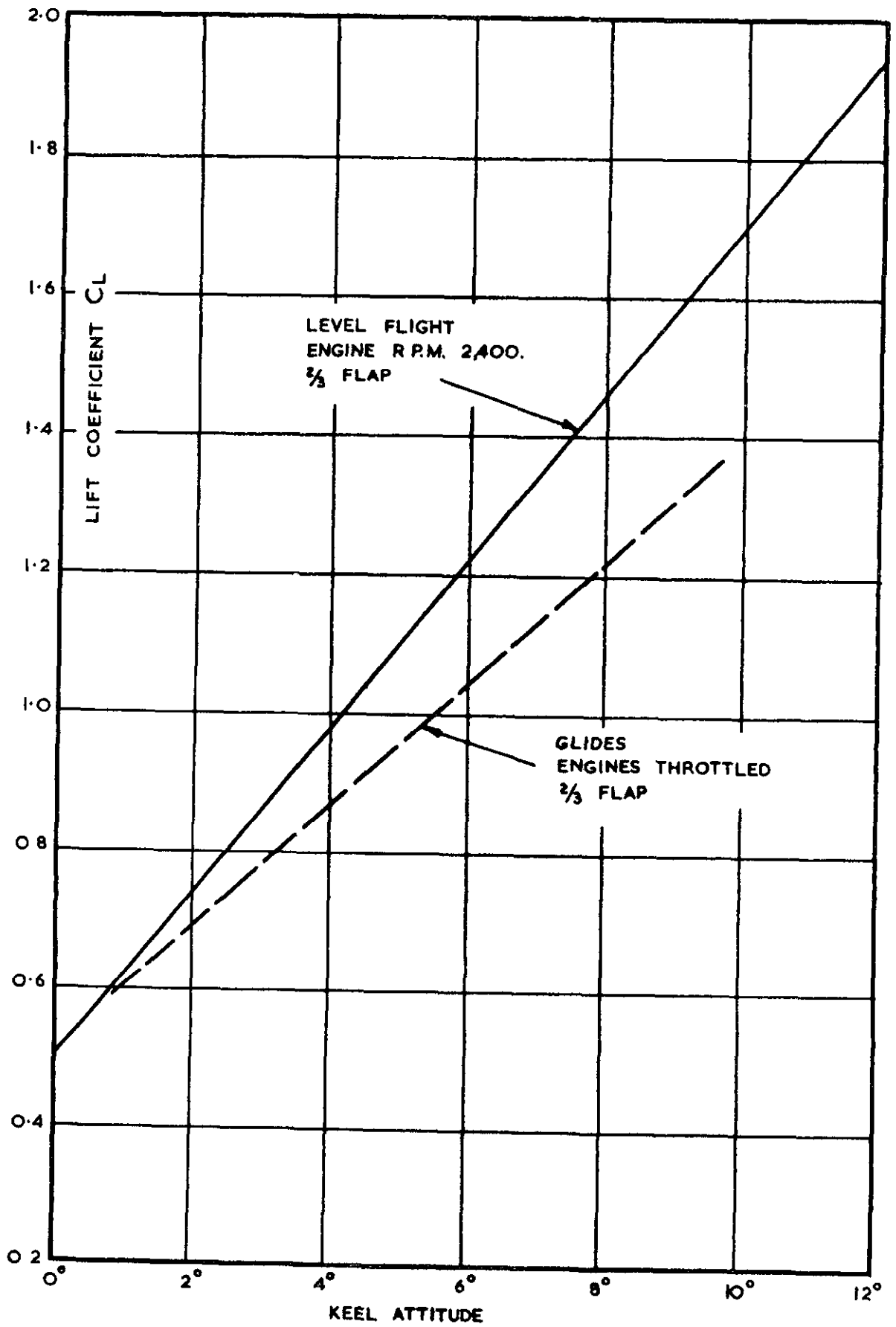

LIFT CURVES FOR SUNDERLAND MK.V WITH 2/3 FLAP.

Crown copyright reserved

Printed and published by
HER MAJESTY'S STATIONERY OFFICE

To be purchased from
York House, Kingsway, London W.C.2
423 Oxford Street, London W.1
13A Castle Street, Edinburgh 2
109 St Mary Street, Cardiff
39 King Street, Manchester 2
Tower Lane, Bristol 1
2 Edmund Street, Birmingham 3
80 Chichester Street, Belfast
or through any bookseller

Printed in Great Britain