

ST. NO. R6337/B
U.D.C.
AUTH A

R & M No 2308
(8540)
A R C Technical Report



MINISTRY OF SUPPLY

AERONAUTICAL RESEARCH COUNCIL
REPORTS AND MEMORANDA

An Analysis of the Lift Slope of Aerofoils of
Small Aspect Ratio, including Fins, with
Design Charts for Aerofoils and
Control Surfaces

By

D J LYONS, B Sc (Eng) - and F/O P L BISGOOD, B Sc (Eng)

Crown Copyright Reserved



LONDON HIS MAJESTY'S STATIONERY OFFICE

1950

PRICE 4s 6d NET

An Analysis of the Lift Slope of Aerofoils of Small Aspect Ratio, including Fins, with Design Charts for Aerofoils and Control Surfaces

By

D. J. LYONS, B.Sc. (Eng.) and F/O. P. L. BISGOOD, B.Sc. (Eng.)

COMMUNICATED BY THE PRINCIPAL DIRECTOR OF SCIENTIFIC RESEARCH (AIR), MINISTRY OF SUPPLY

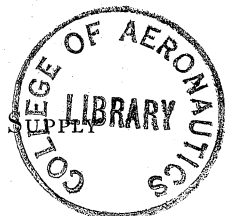

Reports and Memoranda No. 2308

*January, 1945**

The analysis of R.A.E. Report No. Aero. 1840 has been extended to cover the lift slope of aerofoils of small aspect ratio and of fins in place upon an aeroplane. The charts of that report for the estimation of lifting characteristics of aerofoil controls have been included in this report with some small modifications, and those necessary for the estimation of fin and rudder lifting characteristics added. In general it is possible to estimate the lift slope of the aerofoils on an aircraft, taking account of interference effects, to within about ± 5 per cent. and control powers to within about ± 10 per cent.

CONTENTS

	<i>Page</i>
1. Introduction	2
2. Extension of the Aspect Ratio Correction to Aerofoils of Small Aspect Ratio	2
2.1. Method of Analysis	2
2.2. Results of Analysis (Table 1, Fig. 1)	2
3. The Endplate Effect of a Horizontal Surface on a Vertical Surface	3
3.1. General	3
3.2. Central Fins (Figs. 3 (a) and 3 (b))	3
3.3. End Fins (Fig. 3 (b))	4
4. The Lift of Fins in place upon an Aeroplane	5
4.1. Sidewash	5
4.2. Central Fins	5
4.21. Definition of Areas (Fig. 2)	5
4.22. Method of Analysis	5
4.23. Results of Analysis (Table 2, Figs. 4 and 5)	6
4.3. End Fins	6
4.31. Method of Analysis	6
4.32. Results (Table 2, Fig. 6)	7
5. Rudder Power (Table 3, Fig. 7)	7
6. Horizontal Tail Efficiency (Table 3, Fig. 8)	7
7. Estimation of the Lift of Aerofoil Surfaces and Controls	8
7.1. The Lift Slope of Wings and Tailplanes (Figs. 10 and 11)	8
7.2. The Lift Slope of Vertical Fins (Fig. 12)	8
7.3. Elevator Lift Curve Slope (Fig. 13)	8
7.31. Without a cutout	8
7.32. With a cutout	8
7.4. Rudder Lift Curve Slope (Fig. 14)	8
7.5. Rolling Power (Fig. 15)	8
8. Conclusions	8
List of Symbols	9
List of References	10

* R.A.E. Report No. Aero. 2011 received 19th March, 1945.

1. *Introduction.*—Following the analysis of the lift slope of aerofoils and controls reported in Ref. 1, an extension of the work has been made to cover the lift slope of aerofoils of very small aspect ratio and of fins in place on an aircraft. This has been done with a view to improving the estimation of the side loads on a fin and rudder, and of the contribution of the fin and rudder to the yawing moments on an aircraft. At the same time the opportunity has been taken to amend slightly the aspect ratio correction as given in Ref. 1, and to gather together, in the present report, all the charts required for the estimation of the lift of aerofoils and controls produced during the analysis up to date. A change in presentation has been made, in that all the coefficients are now quoted in terms of radians instead of degrees, as it is felt that this is a more useful method of presentation to the British reader.

2. *Extension of the Aspect Ratio Correction to Aerofoils of Small Aspect Ratio.*—2.1. *Method of Analysis.*—In Ref. 1 the correction for aspect ratio was made by use of the formula

$$a_1 = \frac{a_0}{1 + \frac{a_0}{\pi A} (1 + \tau)}, \quad \dots \quad (1)$$

in accordance with Glauert's presentation of the "lifting line" theory. In this formula :—

A = aspect ratio

a_0 = slope of curve of lift coefficient against incidence in radians for infinite aspect ratio

a_1 = ditto for the finite aspect ratio A

τ = a numerical coefficient tabulated by Glauert depending on taper ratio.

This formula was always used since the divergences from it for normal aspect ratios are small. However, two more recent papers^{2,3} give aspect ratio corrections, one slightly and the other widely divergent from (1). The experimental results on the lift slope of aerofoils of medium and small aspect ratio have therefore been examined with a view to determining the relation between aspect ratio and lift slope which most nearly represents that found in experiment.

Now τ in Glauert's equation (1) is dependent on the value of A/a_0 and the taper ratio of the aerofoil only, so that for a given taper ratio a unique curve of a_1/a_0 against A/a_0 can be drawn. Hence in studying the effect of aspect ratio on a_1 , it is to be expected that the variations in a_0 may be eliminated by examining the experimental results on this basis. All the data were corrected to rectangular plan form (this correction is at the most about 4 per cent.), and the value of a_0 has been estimated by the method of Ref. 1. The analysis was confined to the lift slope between ± 10 deg. of incidence. A few cases, where Reynold's number was a little below 10^6 were included, as these showed no marked deviation from the general trend, but in general only tunnel results of Reynold's number greater than 10^6 were relied upon.

2.2. *Results of Analysis.*—Fig. 1 shows the comparison between the mean curve of a_1/a_0 against A/a_0 drawn through the experimental points, the Glauert theoretical curve, and the other empirical curves of Refs. 2 and 3. The scatter of the experimental points about the mean curve drawn is small (usually less than 5 per cent.) and the deviation of this mean curve from Glauert's theoretical curve is really very little. There is no appreciable difference until the value of A/a_0 is less than 0.5, but below that value there is a justification in drawing the mean curve below the Glauert curve, the maximum deviation being of the order of 20 per cent.

The curves of Refs. 2 and 3 give values of a_1 which are both lower than either the theoretical curve or the mean curve of this report. The curve of Ref. 2 is not markedly different, but that of Ref. 3 appears to give much too low a value of a_1 , but as no indication of the method of its construction is given in the report, it is not possible to investigate the cause.

3. *The Endplate Effect of a Horizontal Surface on a Vertical Surface.*—3.1. *General.*—As far as is known, there is no complete work or series of works giving the theoretical value of the endplate effect, such as that due to the tailplane on the fin, when the fin is in a general position relative to the tailplane; but a number of reports^{4, 5, 6} have been issued in which solutions for some of the possible geometrical conformations have been given. As some knowledge of this effect is necessary, however, to estimate the lift slope of the fin and rudder to a fair degree of accuracy, an attempt has been made to synthesise from the solutions published, corrections for the effect with a fin and rudder in a general position. These synthesised corrections cannot be claimed to be theoretically correct, but only to be of the right order so that fair estimations can be made, until the theoretical work is extended to cover the general case.

3.2. *Central Fins.*—The general solution for the endplate effect of the tailplane on a central fin, with the tailplane in any vertical but symmetrical position relative to the fin, has been given by Rotta⁴, but unfortunately this has been proved to be invalid by the results of Katzoff and Mutterperl⁵. They have shown that if the span of the endplate is greater than the span of the surface whose lift is being considered, a considerable error may be introduced by the assumption of minimum induced drag as used by Rotta. In Ref. 5, however, a comparison is drawn between the solution depending on the assumption of minimum induced drag and the more strict solution, for the one case of a horizontal endplate symmetrically placed at the base of a vertical fin.

Now if we write

$$(A_E/A - 1) = K_1 (A_E'/A - 1) \quad \dots \quad (2)$$

where A_E/A = the ratio of the effective aspect ratio to the geometrical aspect ratio for the strict solution of Ref. 5.

and A_E'/A = the ratio of the effective aspect ratio to the geometrical aspect ratio for the solution assuming minimum induced drag,

we can obtain values of K_1 for this one case, the values varying with the ratio of the vertical tail height to the horizontal tail span, and also with the aspect ratio of the vertical surface. The variation with the aspect ratio of the vertical surface can be ignored in most cases as A usually lies between 1.25 and 2.5, and the variation in the value of A_E/A over this range of A is small. The values of K_1 were obtained therefore for a value of A of 1.75. Now, though it is strictly incorrect, it is considered that reasonable values of A_E for the fin with the endplate in any vertical but symmetrical position can be obtained from equation (2) by using the values of A_E'/A from Ref. 4 and the values of K_1 obtained as above.

Fig. 3 (a) gives the deduced endplate corrections as well as the original curves of Refs. 4 and 5 for comparison. Now, the value of A_E/A varies extremely slowly with the change in the parameter, vertical tail height/horizontal tail span, and as for a conventional tail assembly the value of this parameter is usually between 0.25 and 0.7, a further simplification can be introduced by assuming the value of A_E/A is independent of this parameter. We can thus obtain a curve of A_E/A against the vertical position of the horizontal tailplane relative to the fin, and this is shown in Fig. 3 (b). It must be emphasised, however, that this curve will not apply to aeroplanes where the body and not the tailplane forms the endplate, since the endplate span will then be small compared with the aerofoil span; in this case the curves of Fig. 3 (a) must be used.

3.3. *End Fins*.—In the absence of any known published work on the endplate effect of a tailplane on end fins, approximate estimations of the effect have been derived from Refs. 4, 5 and 6 by the following method:

Mangler⁶ has solved the problem for both

(a) two endplates symmetrically placed about an aerofoil surface thus:—

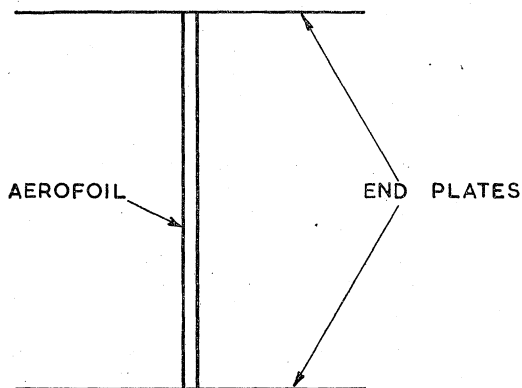

(b) two endplates placed wholly to one side of an aerofoil surface thus:—

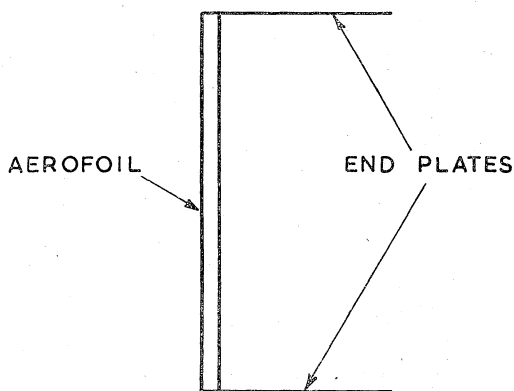

In this report, the assumption of minimum induced drag has been made, but as the ratio of the endplate span to the span of the aerofoil under consideration is less than 1, no serious error is introduced. Now if we write

$(A_E/A - 1)$ for symmetrically placed endplates = $K_2 (A_E/A - 1)$ for asymmetrically placed endplates,

we find that K_2 can be assumed constant and equal to 0.9 for any given value of h/b . The next step is to assume that this factor K_2 still applies when there is only one endplate. We can then deduce from the values of A_E/A for a central fin (Fig. 3 (b))

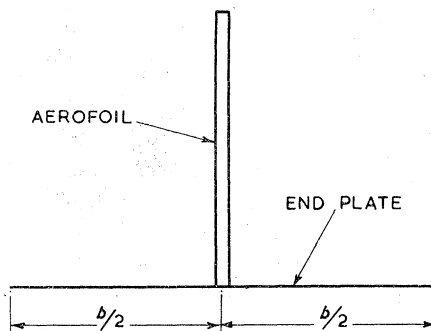

the values of A_E/A for an end fin,

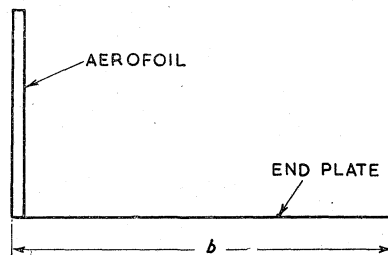

for the conversion of a central fin to an end fin is obtained by moving the endplate (usually the tailplane) from the symmetrical position to the asymmetrical position. The deduced values of A_E/A for end fins are given in Fig. 3 (b).

4. *The Lift of Fins in place upon an Aeroplane.*—4.1. *Sidewash.*—Let us define the lift slope of the fin and rudder on an aeroplane as a_1' , where

$$a_1' = \frac{\Delta n_v \text{ (due to fin)}}{\bar{V}} \text{ or } \frac{2S \Delta y_v \text{ (due to fin)}}{S''}.$$

Then the value of a_1' will be reduced compared with the lift slope of the isolated fin (a_1) by two factors

- (i) the sidewash over the fin and rudder,
- (ii) the reduction in total head of the airstream over the fin and rudder.

The sidewash generated by the trailing vortices of the wing on the fins of the tail surfaces will in general be small (the major part of the sidewash arises from the body), the body shape and the wing body interference effects being the main variables. Engine nacelles will obviously give some contribution, but in the absence of sufficient information on their separate effects, no analysis of these have been made and their effects will be included in the body effects.

Now let us consider separately the cases of end fins and central fins, as there are obviously some fundamental differences between them. In each case we shall combine the effects of sidewash and tail efficiency together, because, when analysing most tunnel results, these two effects are inseparable.

4.2. *Central Fins.*—4.21. *Definition of areas.*—The main practical difficulty when considering the lift of central fins and rudders is the definition of the area, aspect ratio, etc. At the present stage, only an arbitrary definition can be made and in this report a gross area is used for the following reasons:—

- (i) On many aircraft there is considerable difficulty in defining net fin and rudder area, due to the complete merging of the body into the fin and rudder.
- (ii) When estimating rudder power considerable difficulty is encountered in applying the results of systematic tests on control powers, if the net area definition is used and part of the rudder is behind the body.
- (iii) When the gross area definition is used, a fairly systematic variation of fin lift and rudder power with a number of parameters can be found.

Illustrations of the definitions arising from the inclusion of the area of the body under the fin in the fin and rudder area, are given in Fig. 2 for representative types of fin.

4.22. *Method of analysis.*—When a body is yawed to the direction of airflow, a cross flow is caused in the immediate vicinity of the body both above and below it which is at a greater angle to the body axis than the undisturbed airflow. Hence, the effect of the body on the flow round a central fin and rudder, is to cause an increase in the local incidence of the flow, above the angle

of sideslip, on that part of the fin and rudder outside the body. The greatest change in incidence is near the body surface, the change decreasing as the distance from the body increases. Both for this reason and from consideration of the proportion of the body area included in the fin and rudder area, the mean sidewash over the whole fin would be expected to depend upon the ratio of the height of the fin to body height, and though the general shape of the body should strictly be considered, it appears reasonable to suppose that the height of the body in the region of the fin would be the major variable in this effect.

The wing body interference causes a twist to be imparted to the flow around the body when the aircraft is yawed⁷; this will tend to increase the fin lift on a low-wing aircraft and decrease it on a high-wing aircraft. If, however, a horizontal tailplane is present on the body the asymmetric lift produced on this will act as a straightener to this flow. We might therefore expect there to be an appreciable difference on high- and low-wing aircraft between the contribution of the fin and rudder to the yawing moments according to whether a tailplane was present on the body or not. A good demonstration of this is shown by some systematic tests^{8,9,10} on lateral derivatives made on behalf of the National Advisory Committee for Aeronautics, U.S.A.

We have during our analysis of the various wind tunnel tests on fin lift used the following method:—

- (a) Areas, aspect ratios, etc., are defined as in Fig. 2.
- (b) The *combined* effect of the addition of tailplane as well as the fin and rudder to the aircraft is considered.
- (c) Aircraft models with horizontal tails are separated from aircraft models without horizontal tails or with horizontal tails in a high position on the vertical fin well clear of the body.
- (d) The values of a_1'/a_1 have been examined with regard to the variation with

$$\frac{\text{body height at the fin } (w)}{\text{total fin height } (h)}$$

and with fuselage-wing position. The value of a_L , which is the value of the lift curve slope the fin-rudder-horizontal-tail combination would have when isolated from the body, is estimated by the method of Fig. 10 using the endplate corrections of Fig. 9 (b) but assuming the taper ratio is unity because of the difficulty of definition. This appears justifiable because of the small variation of a_1 with taper ratio.

The analysis was limited to a sideslip range of ± 10 deg. and to wing incidences less than 10 deg.

4.23. *Results of analysis.*—The results are given in Figs. 4 and 5, where the value of a_1'/a_1 is plotted against w/h ; Fig. 4 gives the points for models with a tailplane on the body and Fig. 5 for those without a tailplane or with it clear of the body.

It is evident that there is little variation of a_1'/a_1 with variation of wing height on the body when there is a tailplane on the body. It is just possible to suggest three mean curves for the low-, mid- and high-wing models. The scatter from these curves is small except for two points obtained from two high-wing models. Both these aircraft were flying boats in which a sudden change in body section occurs just forward of the fin. It is thought possible that due to this, there is an unusually large stabilising sidewash over the fin arising from the body which causes the rise in the value of a_1'/a_1 .

When there is no tailplane present on the body, there is considerable spread of the points with the position of the body relative to the wing, and though the N.A.C.A. systematic tests^{8,9} form the basis of the curves drawn, representing high-, mid- and low-wing models, there are a few confirmatory points from some British "ad hoc" tests.

4.3. *End Fins.*—4.31. *Method of analysis.*—There is no difficulty about the geometrical definitions of end fins, and from the analysis of central fins (section 4.2) variation in the value a_1'/a_1 with wing-body position would be expected to be small due to the presence of the tailplane on the body. Due, however, to the presence of the body some reduction in the incidence of flow

over the fin would be expected. This reduction should increase as the fins are brought nearer to the body and also as the fin height decreases relative to the body height. The variation of the value of a_1'/a_1 with two parameters has therefore been examined:—

- (i) the ratio of the fin distance from the body centre-line to the length of the body d/l_b .
- (ii) the ratio of the body height at the fin to the fin height, w/h .

4.32. *Results.*—In Fig. 6 the values of a_1'/a_1 for a number of models have been plotted against values of d/l_b . It will be seen that as expected there is a tendency at a constant value of d/l_b for the value a_1'/a_1 to decrease with increase in w/h and a family of curves has been drawn for varying values of w/h from which the scatter is quite small. When the value of d/l_b is greater than 0.6 or so, the indications are that there is negligible interference from the body, and so for end fins on wings the values of a_1'/a_1 can usually be taken as 1.0. What little evidence there is on this point confirms this.

5. *Rudder Power.*—For end fins symmetrical about the tailplane the rudder power can be obtained directly by the method of Ref. 1, but both for asymmetric end fins and central fins the present theoretical and systematic practical knowledge is inadequate to enable one to obtain a really reliable estimate. It is suggested, however, that a very rough estimate may be obtained by the method of Ref. 1, using the part-span flap correction factors given there as applicable to the fin, despite any asymmetry present. For such an estimate the rudder is divided into sections in which the values of C_f/c , balance and trailing edge angle are approximately constant in a similar manner to that suggested in Ref. 1 for an elevator.

Using this method, a comparison has been made between estimated and measured rudder powers, the measured values being obtained from wind tunnel model tests, and a fin and rudder efficiency of 100 per cent. being assumed for the estimations (Fig. 7).

This comparison indicates that the average fin and rudder efficiency on the models is about 90 per cent., and this is supported by a few tests in which the efficiency has been measured directly. There is a tendency for this efficiency to be lower for twin fins if the fins are of small height and in the region of the flow from the nacelles, in that case the mean efficiency may be as low as 80 per cent.

6. *Horizontal Tail Efficiency.*—In order to complete the data needed for the estimation of the lift slopes of all the aircraft surfaces, an investigation has been made of the efficiency of the horizontal tail. The method has been to define the tail efficiency as

$$\frac{\text{the } a_1 \text{ or } a_2 \text{ deduced from wind tunnel tests}}{\text{the } a_1 \text{ or } a_2 \text{ estimated by the method of this report}}$$

assuming in the estimations that the tail surfaces are isolated from the body, and using definitions of aspect ratio, area, etc., based on *gross* tail area. The tail efficiency would then be expected to be dependent on the ratio of tailplane span to the width of the body at the tail; for when these quantities are equal, the efficiency as defined above should be zero, and when the body width is zero, the efficiency should be 100 per cent. except for wing and body wake effects.

In Fig. 8 therefore, the tail efficiency has been plotted against the value of the ratio

$$\frac{\text{body width } (w_1)}{\text{tailplane span } (b)}$$

All of the points obtained from tests on aircraft tailplanes have values of w_1/b less than 0.3, so the resource has been made to fins on bombs and airships to extend the curves to larger values of w_1/b . The analysis of the effect of fins on bombs has already been made by Hills. It should be noted that for the bomb and airship fins direct measurements were not made of the a_1 of the fins, but were deduced from measurements of either Δn_n or Δh_n due to the fins, on the assumption that the sidewash generated by the body lift was negligible.

The trend of the tail efficiency with the value of w_1/b is fairly evident in Fig. 8, and there is evidence from the tests on bomb fins that two separate curves can be drawn, one for fins on faired bodies and one for fins at the end of bluff-ended bodies. The scatter from these two curves is reasonably good in view of the unknown reductions in tail efficiency due to wing and body wake.

7. *Estimation of the Lift of Aerofoil Surfaces and Controls.*—Figs. 9–15 indicate methods of estimation of the values for a_1 and a_2 of all the normal aerofoils and controls of the aircraft, with the tail efficiency of the tail surfaces of the conventional aircraft included. Many of the figures are reproduced from Ref. 1, with, however, some modifications which it is hoped will make the estimations as easy and straightforward as possible.

7.1. *The Lift Slope of Wings and Tailplanes (Figs. 10 and 11).*—Fig. 10 shows the method used and gives or refers to the curves needed in this estimation.

7.2. *The Lift Slope of Vertical Fins (Fig. 12).*—The a_1 which the isolated fin and tailplane combination would have when yawed is estimated by the method of Fig. 10. The value of a_1'/a_1 is then obtained from Fig. 12. Hence the value of a_1' is obtained.

7.3. *Elevator Lift Curve Slope (Fig. 13).*—7.31. *Without a cut-out.*—To obtain the elevator lift curve slope, a_2 , the elevator is first divided into sections in which the values of C_f/c and balance are fairly constant. The value of a_2/a_1 is then obtained from the following equation.

$$a_2/a_1 = [(a_2/a_1)_{s1} \cdot n_1 \cdot f_1 + (a_2/a_1)_{s2} \cdot n_2 \cdot f_2 + \dots]$$

where $(a_2/a_1)_{s1}$ = the value of $(a_2/a_1)_s$ from Fig. 13 for section 1.

n = the value of the balance and gap correction factor from Fig. 13 for section 1.

f_1 = the value of the part span factor from Fig. 13 for section 1.

and similarly for the other sections. Then the value of a_1 is obtained from Fig. 10 and hence the value of a_2 for the isolated tail. The elevator power is then equal to $a_2 \bar{V} \times$ (the tail efficiency), the value of the tail efficiency being obtained from Fig. 8.

7.32. *With a cut-out in the elevator.*—First the value of a_2/a_1 is worked out by the method of Section 7.31 *completely* ignoring the cut-out, i.e. assuming that the elevator is full span. Then an approximate correction for the cut-out is obtained by multiplying the value of a_2/a_1 thus obtained by the factor Z ,

where $Z = \frac{\text{elevator area with cut-out}}{\text{elevator area for the corresponding full span elevator}}$

7.4. *Rudder Lift Curve Slope (Fig. 14).*—A rough estimation of the rudder lift curve slope, a_2 , may be obtained ignoring the asymmetry of the normal rudder. The method is indicated in Fig. 14.

7.5. *Rolling Power (Fig. 15).*—Fig. 15 shows the method and gives or refers to the curves needed in this estimation.

8. *Conclusions.*—(i) Methods of estimation of the lifting characteristics of all the aerofoil surfaces and main controls of the aircraft have been derived; these give an accuracy of the order of ± 5 per cent. for the value of a_1 and ± 10 per cent. for the value of a_2 . Care will be needed when dealing with unconventional layouts, but an attempt has been made to keep the methods as general as possible. This general guarding statement will apply to aerofoils with trailing edge angles greater than 18 deg. or so, when, strictly speaking, the effect of transition point should be included.

- (ii) Many gaps in our knowledge have been revealed, the most important of which are:—
- (a) the lack of a full theoretical work on the end-plate effects on lift.
 - (b) the scarcity of evidence on the variation of sidewash over the fin and rudder, and of the effect of the body shape at the tail on fin and rudder lift.
 - (c) the scarcity of direct measurements of tail efficiency.

LIST OF SYMBOLS

a_0	Two-dimensional slope of aerofoil lift coefficient against incidence curves
a_1	Three-dimensional slope of aerofoil lift coefficient against incidence curves
a_1'	a_1 for a fin with tailplane assembly including sidewash and tail efficiency factors
a_2	Rate of change of aerofoil lift coefficient with control angle
$(a_2/a_1)_s$	The sectional value of a_2/a_1 for an aerofoil with a plain sealed hinged flap
A	Geometrical aspect ratio
A_E	Effective aspect ratio
A_E'	Effective aspect ratio based on assumption of minimum induced drag
b	Total span of an aerofoil
c	Chord of an aerofoil
C_f	The chord of a hinged flap behind the hinge
C_l	The rolling moment coefficient (Rolling moment/ $\frac{1}{2}\rho V^2 S b$)
C_L	The lift coefficient (Lift/ $\frac{1}{2}\rho V^2 S$)
C_r	The aerofoil root chord
C_t	The aerofoil tip chord
d	The distance of end fins from the body centre-line
f	The part span correction factor for elevators (or flaps)
h	The total fin height
h'	The distance of the tailplane from the top of the fin
K	The aspect ratio correction factor on rolling moment
K_1	} Correction factors used in the synthesis of approximate end plate corrections for a horizontal endplate on vertical fins
K_2	
l_b	The total body length
m	The rolling power factor allowing for aileron position
n	The factor correcting a_2/a_1 for the effect of gap and balance
n_v	Rate of change of yawing moment with sideslip ($dC_n/d\beta$)
s	The wing semi-span
S	Total wing area
S''	Gross fin and rudder area
\bar{V}	Tail volume ($\frac{S'l'}{S_c}$)
$\bar{\bar{V}}$	The fin and rudder volume ($S''l''/Sb$)
w	The body depth at the longitudinal position of the fin and rudder
w_1	The body width at the longitudinal position of the tailplane
y_v	Rate of change of side force with sideslip ($\frac{1}{2}dC_y/d\beta$)
Z	The correction factor to allow for the effect of central cutout on a_2
α	Wing incidence
τ	The monoplane coefficient of Glauert
ξ	Aileron angle

REFERENCES

- | <i>No.</i> | <i>Author</i> | <i>Title, etc.</i> |
|------------|----------------------------|--|
| 1 | Naylor and Lyons | An Analysis of the Lifting Characteristics of Aerofoils and Controls with Special Reference to Methods of Estimation for Design Use. R.A.E. Report No. Aero. 1840. A.R.C. 7149. June, 1943. (Unpublished.) |
| 2 | Pass | Analysis of Wind-tunnel Data on Stability and Control. N.A.C.A. T.N.775. September, 1940. |
| 3 | Ames and Sears | Determination of Control Surface Characteristics from N.A.C.A. Plain Flap and Tab Data. N.A.C.A. Rep. 721. 1941. |
| 4 | Rotta | Aerodynamic Forces on a Wing fitted with a Lateral Plate. R.T.P. Translation No. 2039. (<i>Ing-Archiv</i> , Vol. 13, No. 3, 1942, pp. 119-131). |
| 5 | Katzoff and Mutterperl .. | The End Plate Effect of a Horizontal Tail Surface on a Vertical Tail Surface. N.A.C.A. T.N.797. February, 1941. |
| 6 | Mangler | Die Auftriebsverteilung am Tragflügel mit seitlichen Scheiben. <i>Luftfahrtforschung</i> . 20th May, 1939. |
| 7 | Multhopp | Aerodynamics of the Fuselage. <i>Luftfahrtforschung</i> . 29th March, 1941. R.T.P. Translation No. 1220. |
| 8 | Recant and Wallace | Wind-tunnel Investigation of the Effect of Vertical Position of the Wing on the Side Flow in the Region of the Vertical Tail. N.A.C.A. T.N.804. 1941. |
| 9 | Bamber and House | Wind-tunnel Investigation of Effect of Yaw on Lateral Stability Characteristics. II. Rectangular NACA 23012 Wing with a Circular Fuselage and Fin. N.A.C.A. T.N.730. September, 1939. |
| 10 | Recant and Wallace | Wind-tunnel Investigation of Effect of Yaw on Lateral Stability Characteristics. III. Symmetrically Tapered Wing at Various Positions on Circular Fuselage with and without a Vertical Tail. N.A.C.A. T.N.825. 1941. |
| 11 | Imlay | The Estimation of the Rate of Change of Yawing Moment with Sideslip. N.A.C.A. T.N.636. February, 1938. |
| 12 | Glauert | The Elements of Aerofoil and Airscrew Theory. Cambridge University Press. 1926. |
| 13 | Shaw and White | Measurements of Hinge Moments and Pressure Plotting on a Swordfish Rudder in the 24-ft. Tunnel. R. & M. 1976. September, 1938. |
| 14 | Harris | Reduction of Hinge Moment of Airplane Control Surface by Tabs. N.A.C.A. Report 528. 1936. |
| 15 | Zimmerman | Characteristics of Clark Y Airfoil of Small Aspect Ratios. N.A.C.A. Report 431. 1932. |
| 16 | Silverstein and Katzoff .. | Aerodynamic Characteristics of Horizontal Tail Surfaces. N.A.C.A. Report 688. 1940. |
| 17 | Goett and Reeder | Effects of Elevator Nose Shape, Gap, Balance and Tabs on the Aerodynamic Characteristics of a Horizontal Tail Surface. N.A.C.A. Report 675. 1940. |
| 18 | Adamson and Barnes | The Effect of Nose Shape and Gaps on Elevator Balance and the Effect of Tabs on a 16 per cent. Thick Tailplane. R. & M. 2326. May, 1940. (To be published.) |
| 19 | Jacobs and Sherman | Airfoil Section Characteristics as affected by Variations of the Reynolds Number. N.A.C.A. Report 586. 1937. |
| 20 | Priestley | Variations of Effective Aspect Ratio and Slope of the Lift Curve due to Twin Fins. R.A.E. Report No. Aero. 1814. A.R.C. 6796. April, 1943. (Unpublished.) |
| 21 | Levačić | Rolling Moment due to Sideslip. Part I. R.A.E. Report No. Aero. 2028. A.R.C. 8709. April, 1945. Part II. R.A.E. Report No. Aero. 2092. A.R.C. 9278. November, 1945. Part III. R.A.E. Report. No. Aero. 2139. A.R.C. 9987. July, 1946. (Unpublished.) |

TABLE 1
Key to Fig. 1

No. IN REFERENCE LIST	AIRCRAFT &/OR CONTROL	SYMBOL
15	TAILPLANE, SQUARE TIPS	X
15	TAILPLANE, FAIRED TIPS	⊗
15	TAILPLANE, SEMICIRCULAR TIPS	x
-	TAILPLANE	⊙ ⊠ ⊡
14	TAILPLANE	+
-	AIRCRAFT 1 TAILPLANE	⊙
17	TAILPLANE	⊖
-	AIRCRAFT 2 TAILPLANE	⊘
-	AIRCRAFT 3 (ORIGINAL)	⊕
-	AIRCRAFT 3 (ENLARGED)	⊕
-	AIRCRAFT 4 FIN	Δ
-	AIRCRAFT 5 TAILPLANE	T
-	AIRCRAFT 5 TAILPLANE (E.C.1240 SECTION)	T
-	BLACKBURN 0018-J TAILPLANE	⊕
-	TAILPLANE	⊕
-	AIRCRAFT 6 TAILPLANE	⊕
18	TAILPLANE, 16% THICK.	⊕
16	TAILPLANE, GOTTINGEN 409	⊕
16	TAILPLANE	∇
-	AIRCRAFT 7 - FIN	⊕
-	AIRCRAFT 7 - FIN	⊕

11

TABLE 2
Key to Figs. 4 and 5.

No. IN REFERENCE LIST	AIRCRAFT	WING POSITION	SYMBOL	
9, 10	AIRCRAFT 2	HIGH	+	
	N.A.C.A. MODEL §	"	x	
	FLYING BOAT 1	"	*	
	FLYING BOAT 2	"	*	
	AIRCRAFT 8	"	*	
	AIRCRAFT 9	MID	⊠	
	AIRCRAFT 10	"	⊠	
	AIRCRAFT 11	"	⊠	
	AIRCRAFT 12	"	⊠	
	AIRCRAFT 13	"	⊠	
	9, 10	N.A.C.A. MODEL §	"	⊠
		AIRCRAFT 14 (4 1/2% DIHEDRAL)	"	⊠
		AIRCRAFT 14 (6 1/2% DIHEDRAL)	"	⊠
AIRCRAFT 1		"	⊠	
AIRCRAFT 4 (LARGE CENTRAL FIN)		"	⊠	
AIRCRAFT 4 (SMALL CENTRAL FIN)		"	⊠	
AIRCRAFT 15 §		"	⊠	
AIRCRAFT 16		"	⊠	
AIRCRAFT 17		"	⊠	
AIRCRAFT 18		"	⊠	
AIRCRAFT 19		"	⊠	
9, 10		N.A.C.A. MODEL §	LOW	⊙
		AIRCRAFT 20	"	⊙
	AIRCRAFT 20 (ENLARGED FIN)	"	⊙	
	AIRCRAFT 21	"	⊙	
	AIRCRAFT 22	"	⊙	
	AIRCRAFT 5 §	"	⊙	
	AIRCRAFT 23	"	⊙	
	AIRCRAFT 23 (ENLARGED FIN)	"	⊙	
	AIRCRAFT 24	"	⊙	
	AIRCRAFT 25	"	⊙	
AIRCRAFT 26 (WITH HORIZONTAL TAIL)	"	⊙		
AIRCRAFT 26 (WITHOUT HORIZONTAL TAIL)	"	⊙		

§ TESTS CARRIED OUT WITH & WITHOUT TAILPLANE ON BODY.

TABLE 3
Key to Figs. 6, 7 and 8

No IN REFERENCE LIST	AIRCRAFT	SYMBOL
	AIRCRAFT 27	⊙
	FLYING BOAT 3 WITH SMALL END FINS	⊖
	AIRCRAFT 4 (NORMAL FINS)	+
	AIRCRAFT 4 (SMALL FINS)	⊕
	AIRCRAFT 4 (FINS WITH UNSHIELDED HORN-BALANCED RUDDERS)	⊕
	AIRCRAFT 9(TWIN FINS)	⊗
	AIRCRAFT 3 (ORIGINAL FINS)	△
	AIRCRAFT 3 (ENLARGED FINS)	⊞
	AIRCRAFT 28	△
	AIRCRAFT 28	▽
	AIRCRAFT 1 (TWIN FINS)	□
	AIRCRAFT 29	⊠
	AIRCRAFT 29	⊡
	AIRCRAFT 8 (ORIGINAL TAILPLANE)	⊠
	AIRCRAFT 8 (ORIGINAL TAILPLANE)	⊞
	AIRCRAFT 8 (ORIGINAL TAILPLANE)	⊞
	AIRCRAFT 8 (ENLARGED TAILPLANE)	⊞
	AIRCRAFT 30	⊕
	AIRCRAFT 30 (ENLARGED FINS)	⊕
	AIRCRAFT 10	□
	AIRCRAFT 9	x
	FLYING BOAT 1	⊕
	AIRCRAFT 13	⊞
	AIRCRAFT 11	•
	AIRCRAFT 5	T
	AIRCRAFT 14	⊞
	AIRCRAFT 15	⊞
	AIRCRAFT 12	⊖
	AIRCRAFT 22	⊖
	AIRCRAFT 21	⊖
	AIRCRAFT 21A	⊖
	AIRCRAFT 23	⊖
	AIRCRAFT 31	⊖
	FLYING BOAT 2	*
	AIRCRAFT 32	⊖
	AIRCRAFT 33	⊖
	AIRCRAFT 34	⊖
	AIRCRAFT 35	⊖
	AIRCRAFT 36	⊖
	AIRCRAFT 37	⊖
	AIRCRAFT 25	⊖
	AIRCRAFT 16	⊖
	AIRCRAFT 18	⊖
	AIRSHIP 1	⊖
	AIRSHIP 1A	⊖
	BOMBS WITH BLUFF-ENDED BODIES	⊖
	BOMBS WITH FAIRED BODIES	⊖

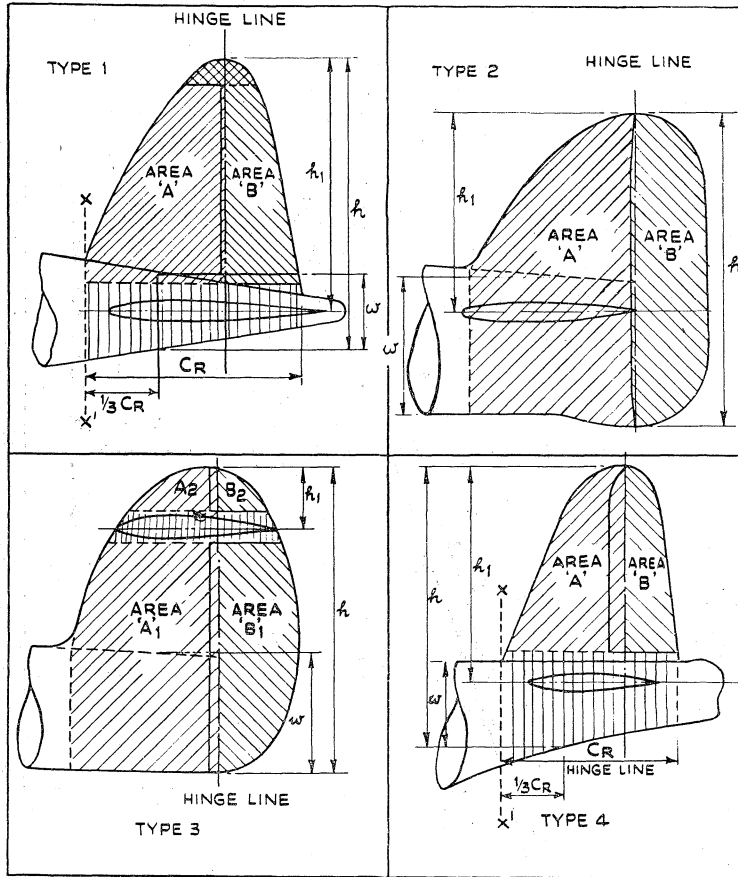

- (a) GROSS FIN AREA, $S =$ TOTAL SHADED AREA IN THE ABOVE SKETCHES.
- (b) FIN HEIGHT, h_1 , IN TYPES 2 & 3 IS MEASURED FROM TOP TO BOTTOM OF FIN; IN TYPES 1 & 4 IT IS MEASURED FROM TOP OF FIN TO POINT ON UNDERSIDE OF FUSELAGE $\frac{1}{3} C_R$ AFT OF LINE $X-X'$.
- (c) GEOMETRIC ASPECT RATIO = $\frac{h_1^2}{\text{TOTAL SHADED AREA}}$
- (d) LOCAL $C_f/C = \frac{\text{AREA A}' + \text{AREA B}'}{\text{AREA B}'}$. FOR TYPE 3, THE LOCAL C_f/C FROM TOP OF FIN TO TOP OF TAILPLANE CUT-OUT = $\frac{B_2}{A_2 + B_2}$ & FROM BOTTOM OF TAILPLANE CUT-OUT TO BOTTOM OF FIN = $\frac{B_1}{A_1 + B_1}$
- (e) OWING TO DIFFICULTY OF DEFINITION, THE TAPER RATIO IS TAKEN AS UNITY (THE MAXIMUM ERROR INVOLVED $\approx 4\%$)
- (f) IN ESTIMATING α_1 , THE GAP IS TREATED AS BEING FULL SPAN.

FIG. 2. Typical Examples of Fins and Rudders.

FIG. 1. Relation between Lift Slope and Aspect Ratio for Rectangular Aerofoils.

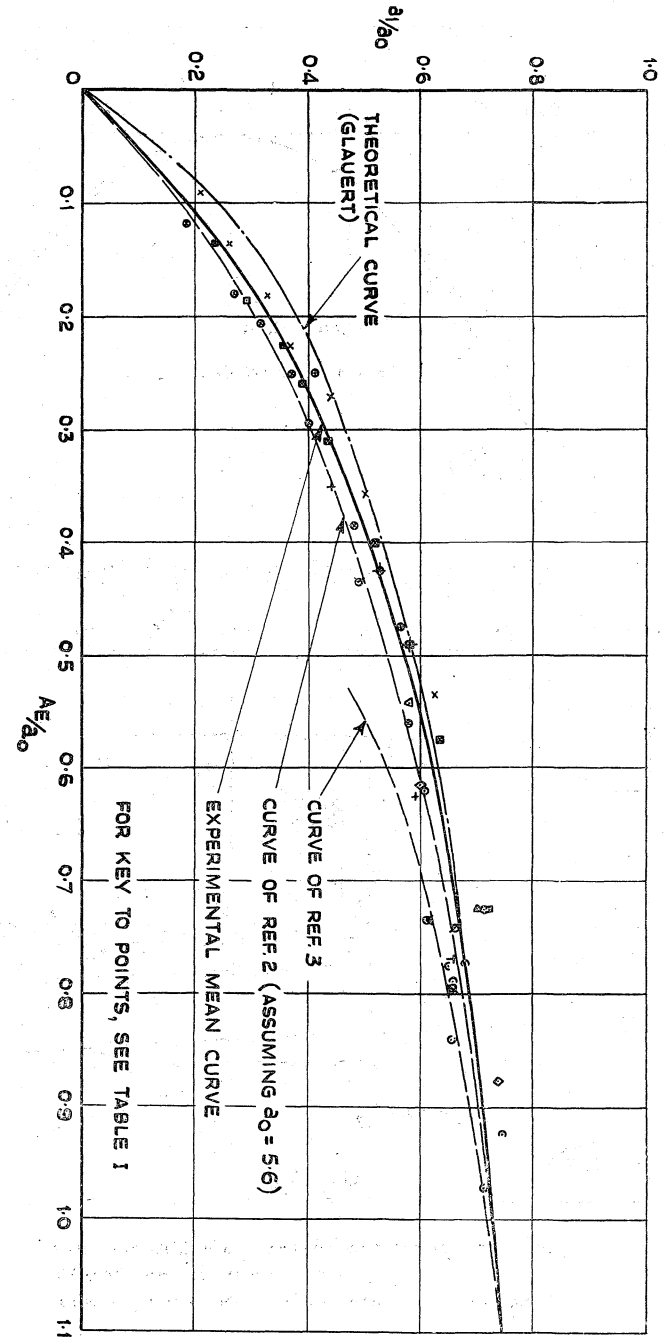

Fig. 4. Variation of a_1'/a for a Central Fin in Position upon an Aircraft, with Tailplane on the Body.

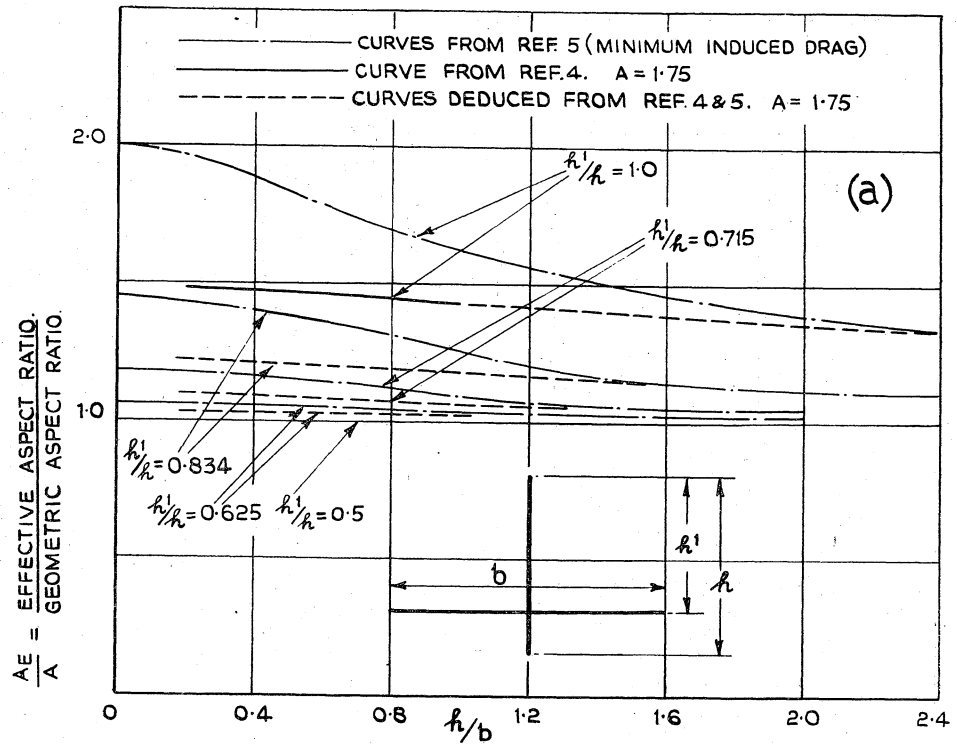
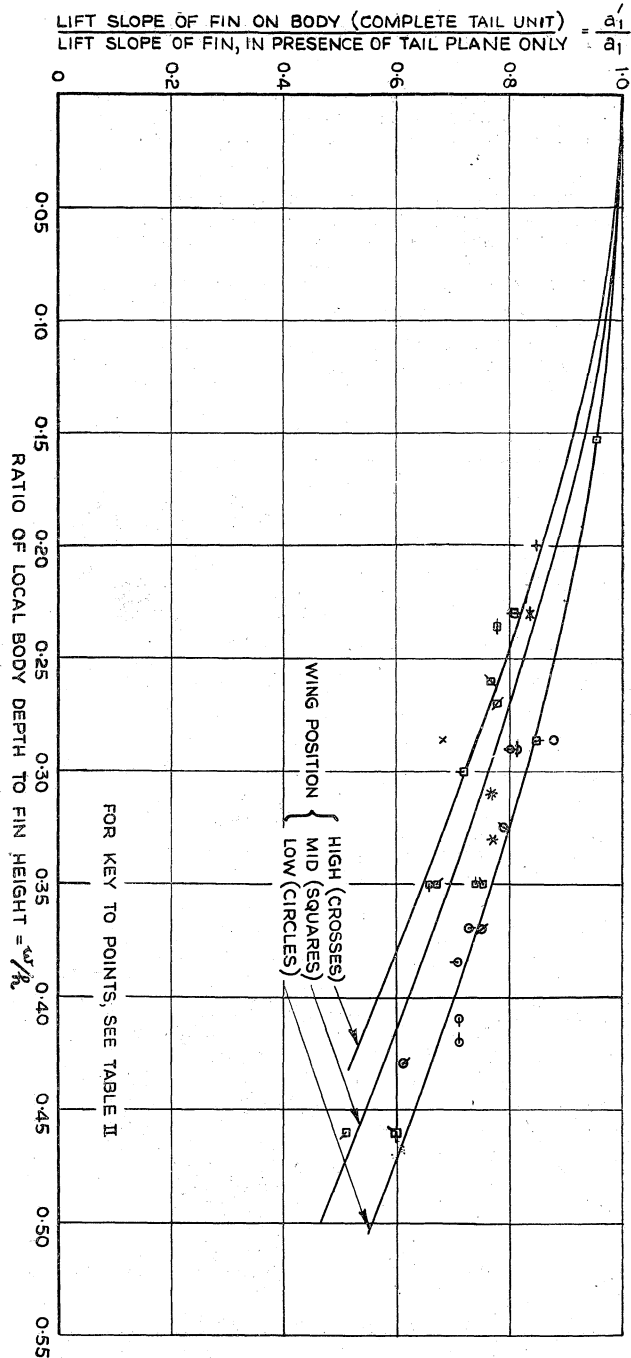

FIG. 3 (a). Endplate Correction of a Tailplane on a Central Fin.

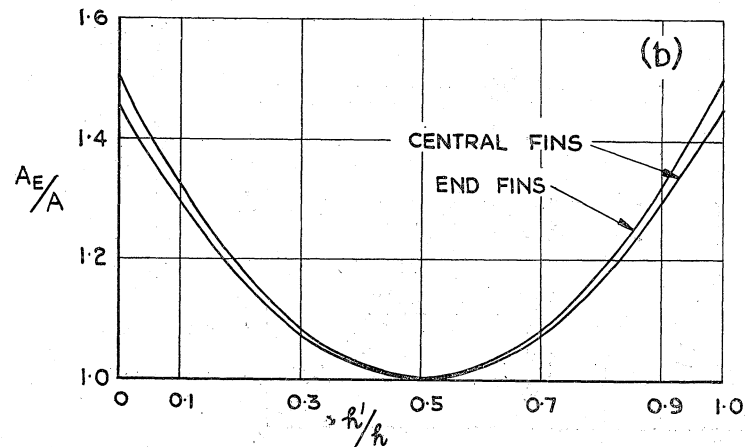

FIG. 3 (b). Simplified Endplate Corrections for Central and Twin Fins.

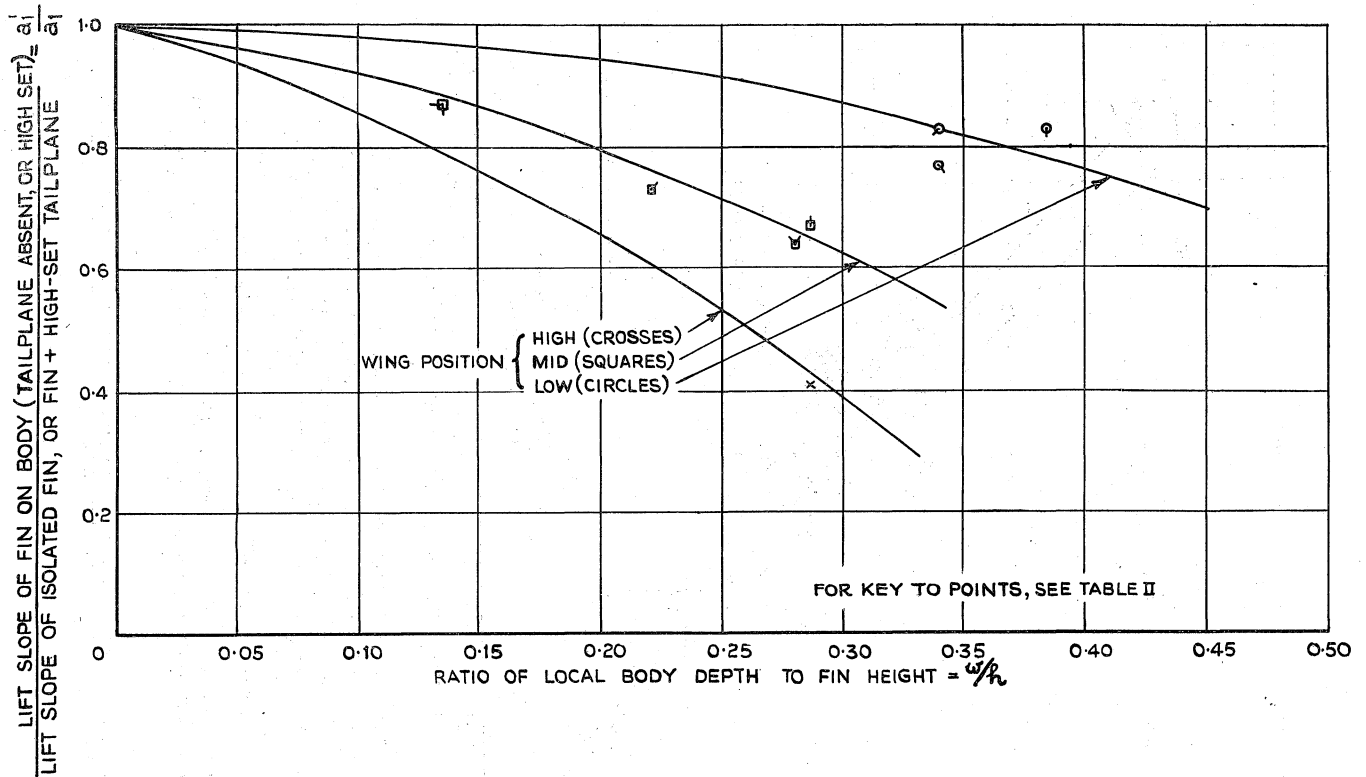

Fig. 5. Variation of a_1'/a_1 for a Central Fin in Position upon an Aircraft with Tailplane Absent, or High-set and Clear of Body.

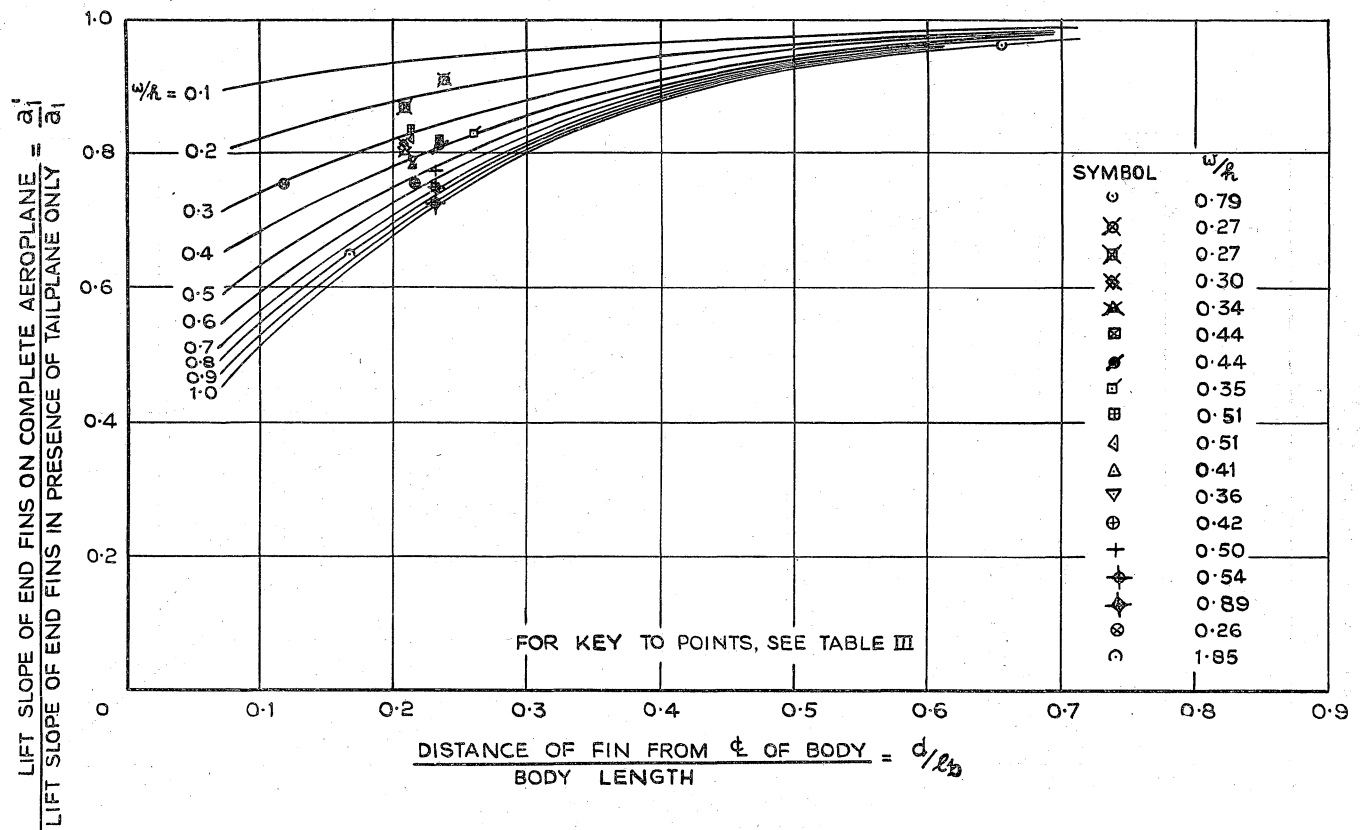

Fig. 6. Variation of a_1'/a_1 for End Fins in Position upon a Complete Aircraft.

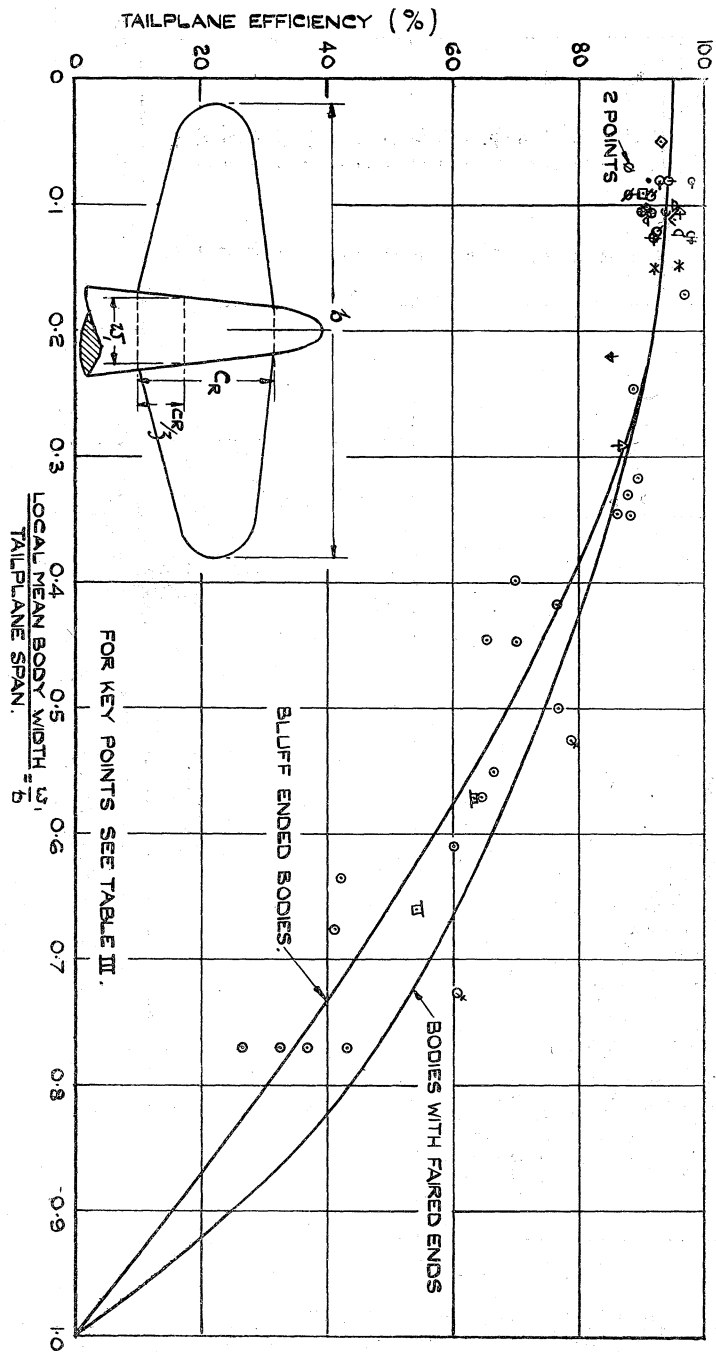
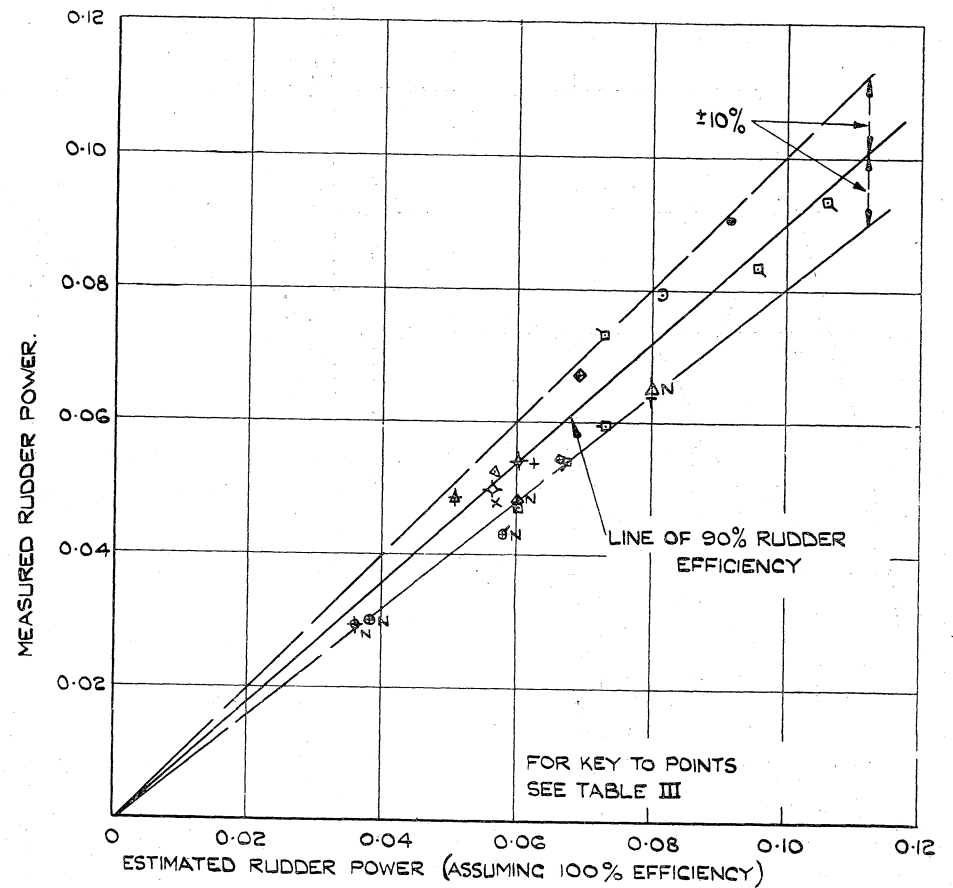

Fig. 8. Variation of Tailplane Efficiency with Local Body Thickness.



NOTE - IN THE ABOVE FIGURE, RUDDER POWER IS BASED ON THE VERTICAL TAIL AREA, AS DEFINED IN FIG 2. A FIN & RUDDER EFFICIENCY OF 100% WAS ASSUMED IN THE ESTIMATION. COMPARING THE MEASURED & ESTIMATED VALUES, THE MEAN EFFICIENCY IS FOUND TO BE 90%

$$i.e. (a_2 \bar{v})_{MEASURED} \approx 0.90 (a_2 \bar{v})_{ESTIMATED}$$

THE POINTS MARKED 'N' IN THE FIGURE, DENOTE SMALL FINS IN THE REGION OF THE NACELLE WAKE & FOR THESE FINS, THE MEAN EFFICIENCY IS 80%

FIG. 7. Comparison of Measured and Estimated Values of Rudder Power.

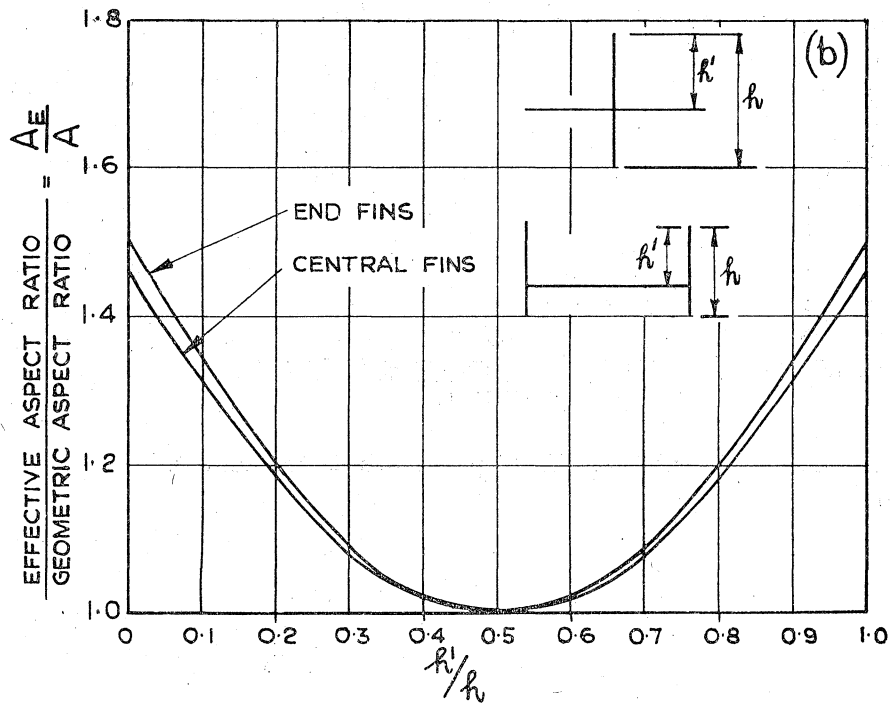
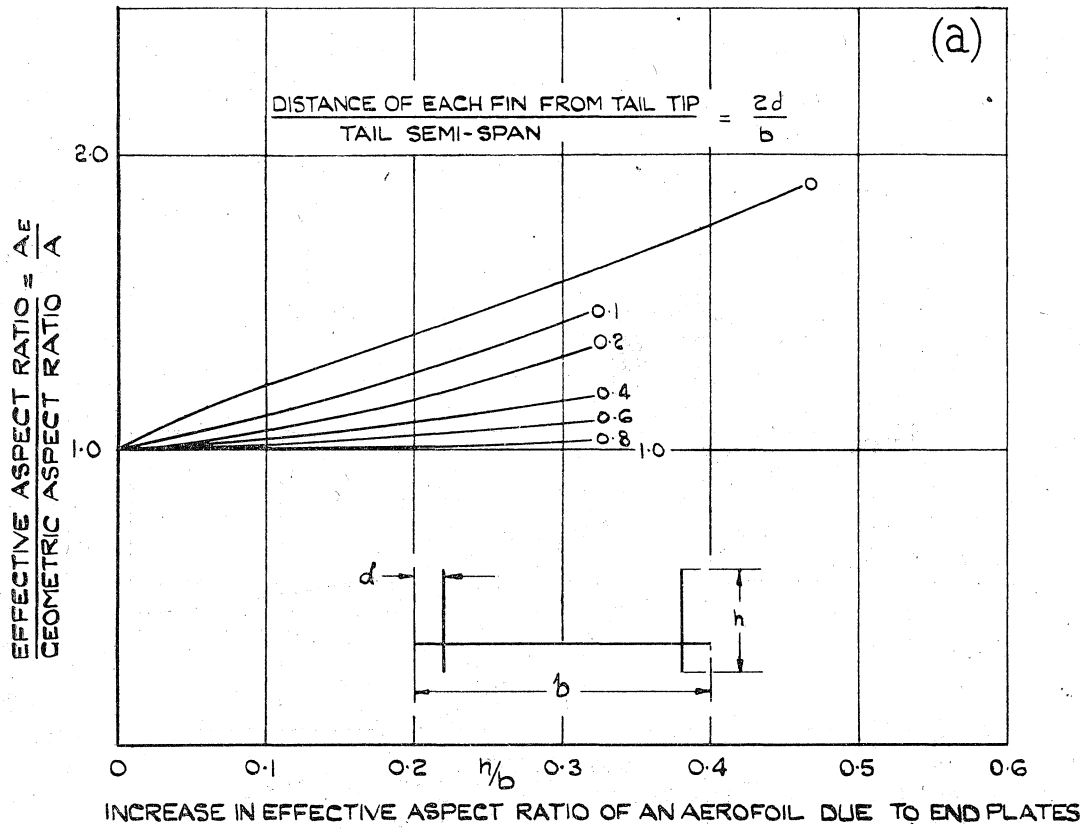

FIG. 9. Estimation of Effective Aspect Ratio.

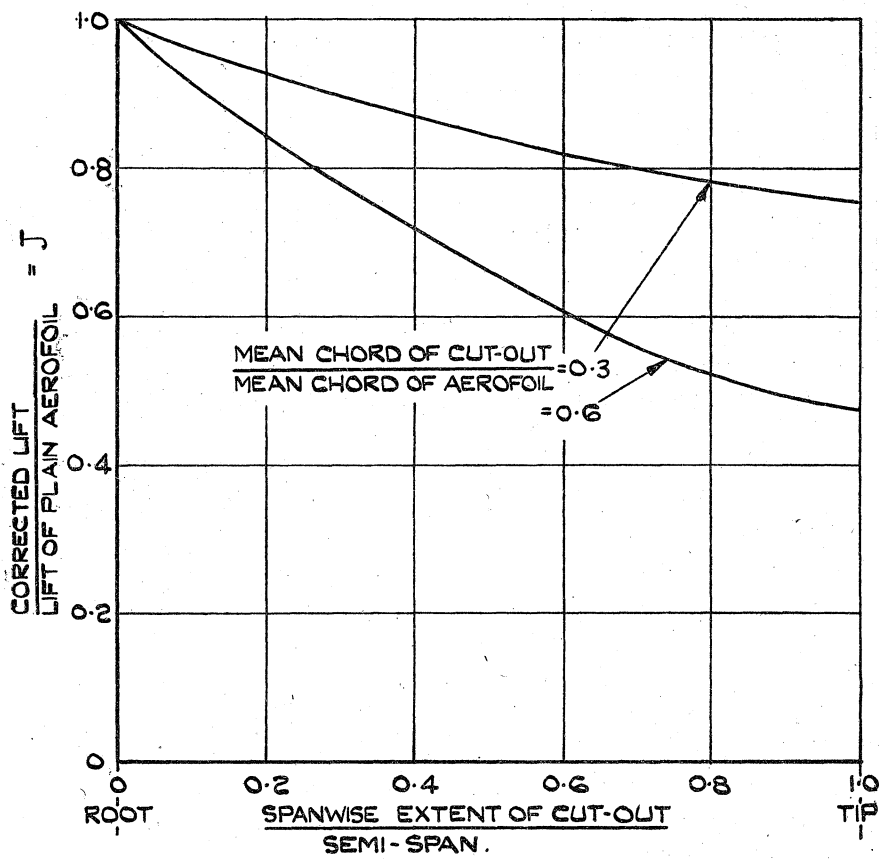

FIG. 11. Reduction in Lift Slope due to a Central Cut-out.

METHOD OF ESTIMATING α_1 FOR AN AEROFOIL
WITH OR WITHOUT END-PLATES

① NECESSARY DATA

- (a) TRAILING EDGE ANGLE
- (b) CONTROL GAP SIZE. - IF $< 0.0025\bar{c}$ TREAT AS SEALED
IF $> 0.0025\bar{c}$ TREAT AS UNSEALED.
- (c) CONTROL GAP POSITION, MEASURED FROM TRAILING
EDGE & EXPRESSED AS A PERCENTAGE OF THE
AEROFOIL MEAN CHORD
- (d) EFFECTIVE ASPECT RATIO (SEE FIGS. 9(a) & (b) FOR ENDPLATE CORRECTIONS)
- (e) TAPER RATIO = $\frac{\text{ROOT CHORD}}{\text{TIP CHORD}}$

② EXAMPLE OF METHOD

TO ESTIMATE THE LIFT SLOPE OF AN AEROFOIL
FOR THE FOLLOWING CONDITIONS :-

- (a) TRAILING EDGE ANGLE = 14°
- (b) UNSEALED, FULL SPAN CONTROL GAP AT 40%
OF THE MEAN CHORD AHEAD OF THE TRAILING EDGE
- (c) EFFECTIVE ASPECT RATIO = 4
- (d) TAPER RATIO = 1.5

THE TRACE A.B.C.D. INDICATES THE METHOD ADOPTED

- (i) A VERTICAL LINE A.B. IS DRAWN THROUGH 14° ON THE
T.E. ANGLE SCALE TO MEET THE APPROPRIATE GAP
CORRECTION CURVE (I.E. GAP 40% \bar{c} AHEAD OF
THE T.E.) AT B.
- (ii) FROM B, A HORIZONTAL LINE IS DRAWN TO MEET
THE ASPECT RATIO CORRECTION CURVE ($A_E = 4$) AT C.
- (iii) FROM C, A VERTICAL LINE IS DRAWN TO MEET THE
TAPER RATIO CORRECTION CURVE ($C_R/C_T = 1.5$) AT D.
- (iv) THE REQUIRED VALUE OF α_1 IS READ OFF THE CIRCULAR
SCALE I.E. $\alpha_1 = 3.45$. FOR A REAR TAILPLANE ON THE
BODY, THIS VALUE MUST BE CORRECTED FOR
TAILPLANE EFFICIENCY (SEE FIG. 8.)

③ NOTE.

FOR THE EFFECTS OF A CENTRAL CUT-OUT SEE FIG. 11.

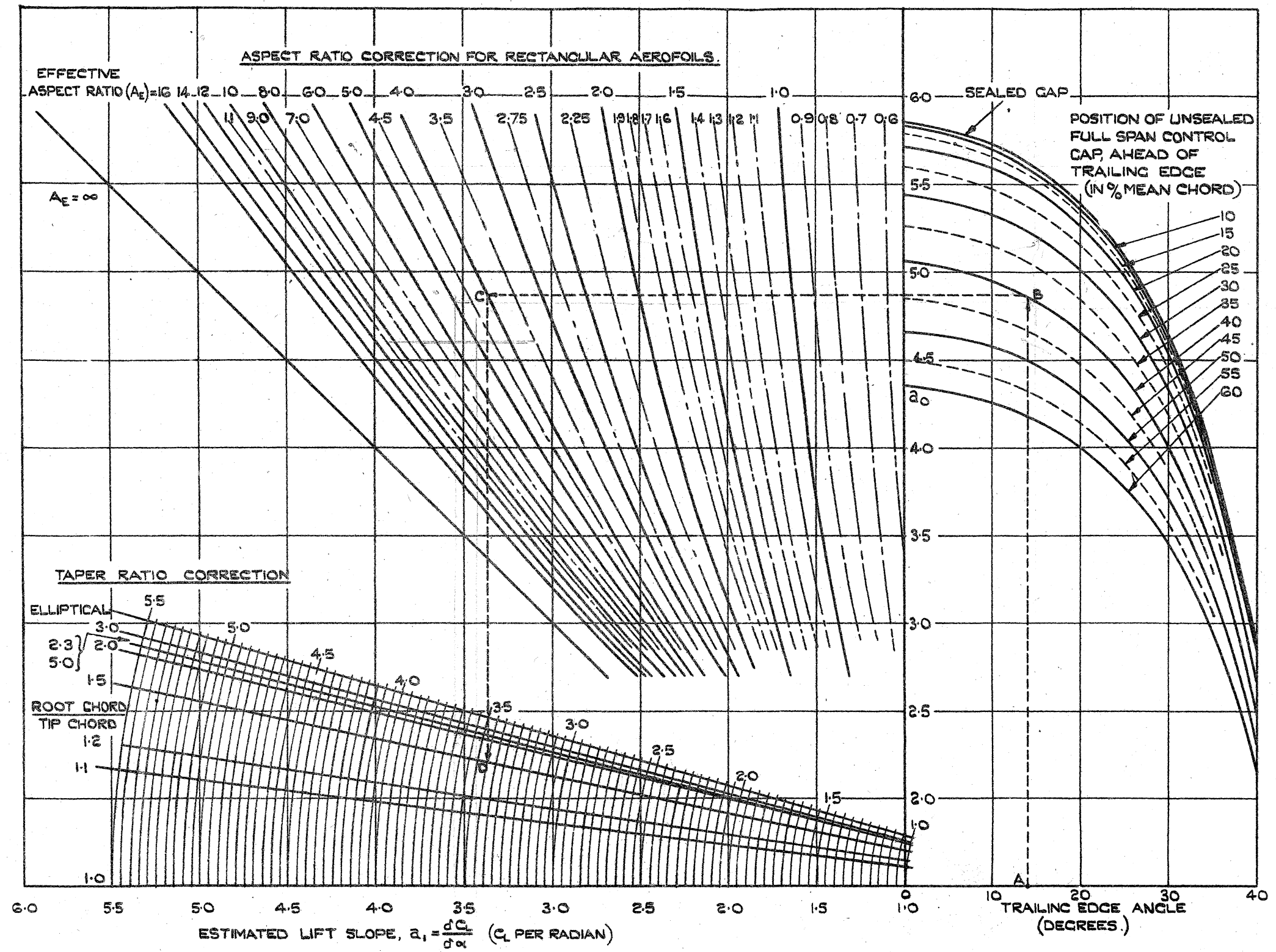

CHART FOR ESTIMATION OF a_1

FIG. 12.

GENERAL NOTE:-
 OWING TO THE DIFFICULTY OF DEFINITION, THE TAPER RATIO TERM IS HEREIN NEGLECTED. THE ERROR SO INTRODUCED IS LESS THAN 4%.

METHOD OF ESTIMATING a'_1 FOR A CENTRAL FIN IN POSITION ON AN AEROPLANE

- ① **NECESSARY DATA.**
 IN ADDITION TO THE LIST OF NECESSARY DATA GIVEN IN § ① OF FIG. 10 (SEE FIG. 2. FOR DEFINITIONS OF FIN AREA & ASPECT RATIO), THE FOLLOWING ITEMS ARE REQUIRED:-

- (a) $\frac{\text{VERTICAL DISTANCE OF TAILPLANE FROM TOP OF FIN}}{\text{TOTAL FIN HEIGHT}} = \frac{h'}{h}$
 (b) $\frac{\text{BODY HEIGHT AT FIN}}{\text{TOTAL FIN HEIGHT}} = \frac{w}{h}$ (SEE FIG. 2. FOR DEFINITIONS OF w & h)

② **METHOD OF ESTIMATION.**

- (a) **TAILPLANE ON BODY**
 (i) ESTIMATE THE VALUE OF a_1 AS LAID DOWN IN § 2 OF FIG. 10.
 (ii) USING THE APPROPRIATE VALUE OF w/h , READ THE VALUE OF a'_1/a_1 OFF THE APPROPRIATE FULL-LINE CURVE IN FIG.(a) ON LEFT.
 (iii) TO OBTAIN THE VALUE OF a'_1 , MULTIPLY THE RESULTS OF (i) & (ii) ABOVE
 i.e. $a'_1 = a_1 \times a'_1/a_1$
- (b) **TAILPLANE ABSENT, OR HIGH-SET & CLEAR OF BODY.**
 (i) ESTIMATE THE VALUE OF a_1 AS LAID DOWN IN § 2 OF FIG. 10.
 (ii) USING THE APPROPRIATE VALUE OF w/h , READ THE VALUE OF a'_1/a_1 OFF THE APPROPRIATE DOTTED CURVE IN FIG.(a) ON LEFT.
 (iii) TO OBTAIN THE VALUE OF a'_1 , MULTIPLY THE RESULTS OF (i) & (ii) ABOVE.
 i.e. $a'_1 = a_1 \times a'_1/a_1$

$\Delta n_v \text{ DUE TO FIN} = a'_1 \bar{V}$

METHOD OF ESTIMATING a'_1 FOR AN END FIN IN POSITION ON AN AEROPLANE.

- ① **NECESSARY DATA.**
 IN ADDITION TO THE LIST OF NECESSARY DATA, GIVEN IN § ① OF FIG. 10. THE FOLLOWING ITEMS ARE REQUIRED:-

- (a) $\frac{\text{VERTICAL DISTANCE OF TAILPLANE FROM TOP OF FIN}}{\text{TOTAL FIN HEIGHT}} = \frac{h'}{h}$
 (b) $\frac{\text{BODY HEIGHT AT FIN}}{\text{TOTAL FIN HEIGHT}} = \frac{w}{h}$
 (c) $\frac{\text{HORIZONTAL DISTANCE OF FIN FROM BODY}}{\text{TOTAL BODY LENGTH}} = \frac{d}{l_b}$

② **METHOD OF ESTIMATION**

- (i) ESTIMATE THE VALUE OF a_1 , AS LAID DOWN IN § ② OF FIG. 10.
 (ii) USING THE APPROPRIATE VALUES OF d/l_b & w/h , READ THE VALUE OF a'_1/a_1 OFF THE CURVE IN FIG.(b) ON LEFT.
 (iii) TO OBTAIN THE VALUE OF a'_1 , MULTIPLY THE RESULTS OF (i) & (ii) ABOVE. i.e. $a'_1 = a_1 \times a'_1/a_1$

$\Delta n_v \text{ DUE TO FIN} = a'_1 \bar{V}$

CHARTS FOR ESTIMATING a'_1 & Δn_v OF FIN.

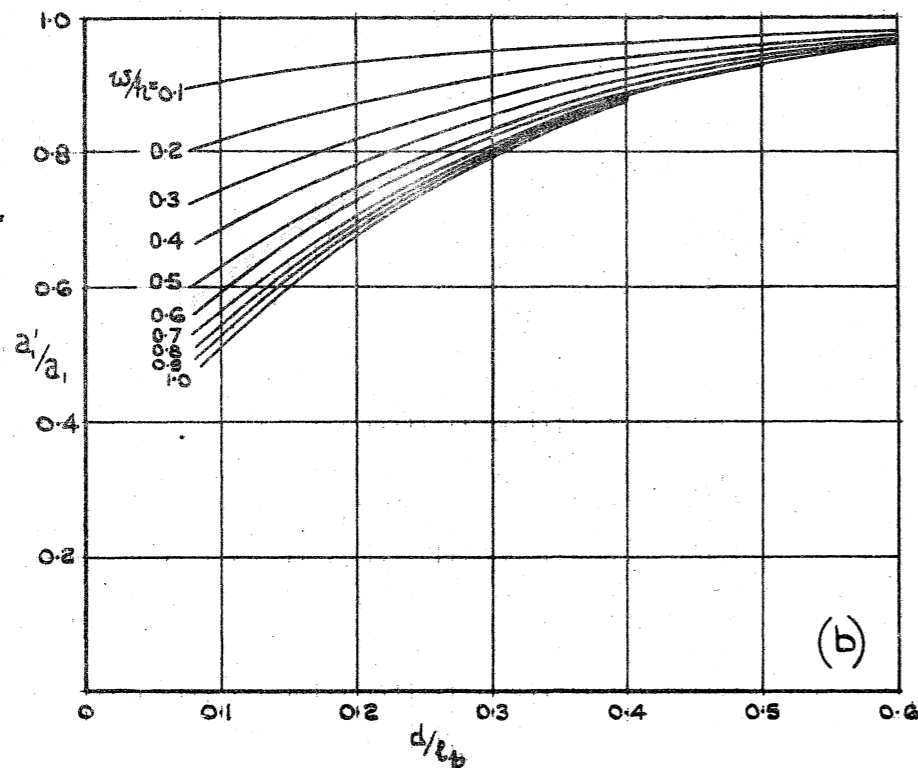
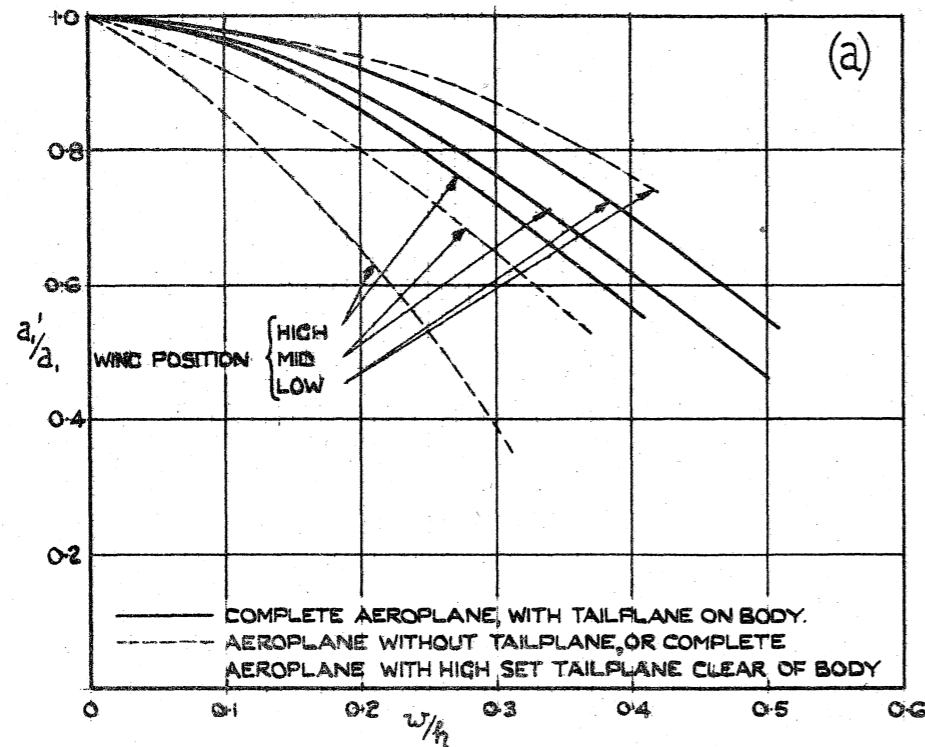
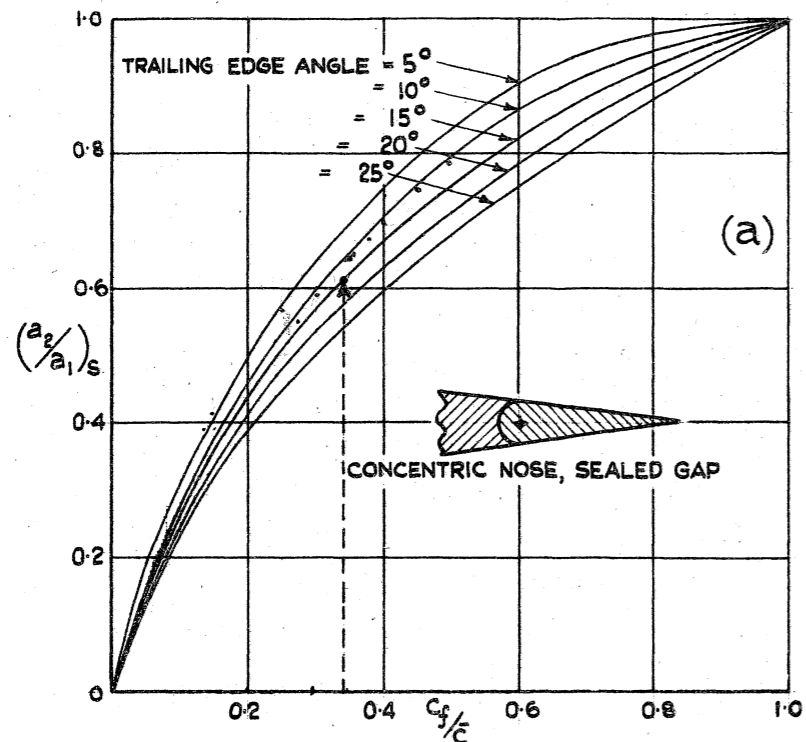
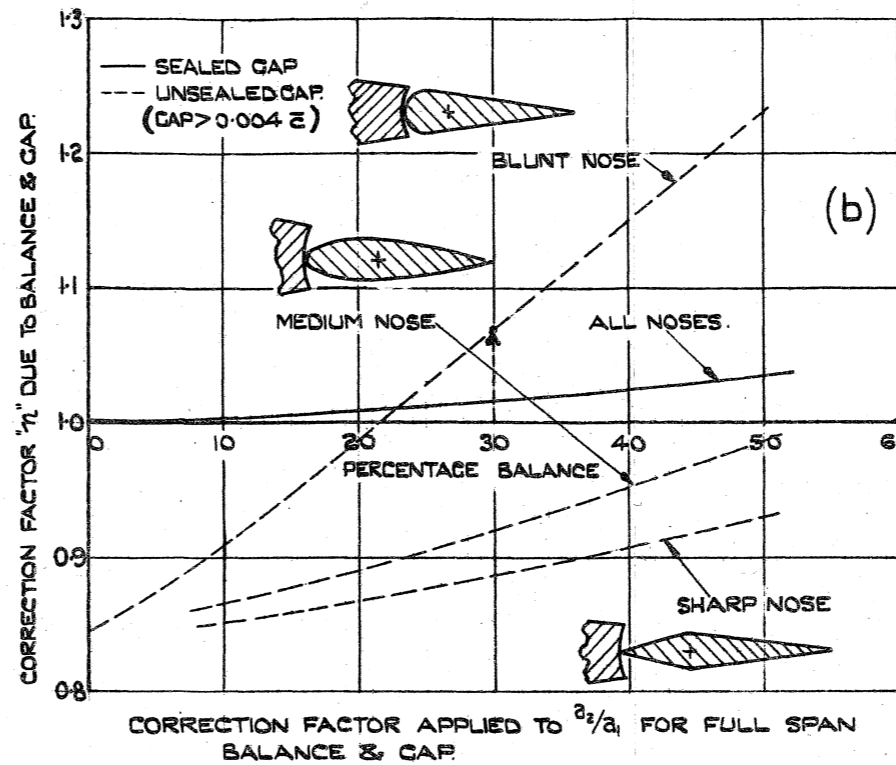

FIG 13.



VARIATION OF $(a_2/a_1)_s$ WITH CONTROL CHORD & TRAILING EDGE ANGLE FOR FULL-SPAN CONTROLS



CORRECTION FACTOR APPLIED TO a_2/a_1 FOR FULL SPAN BALANCE & GAP

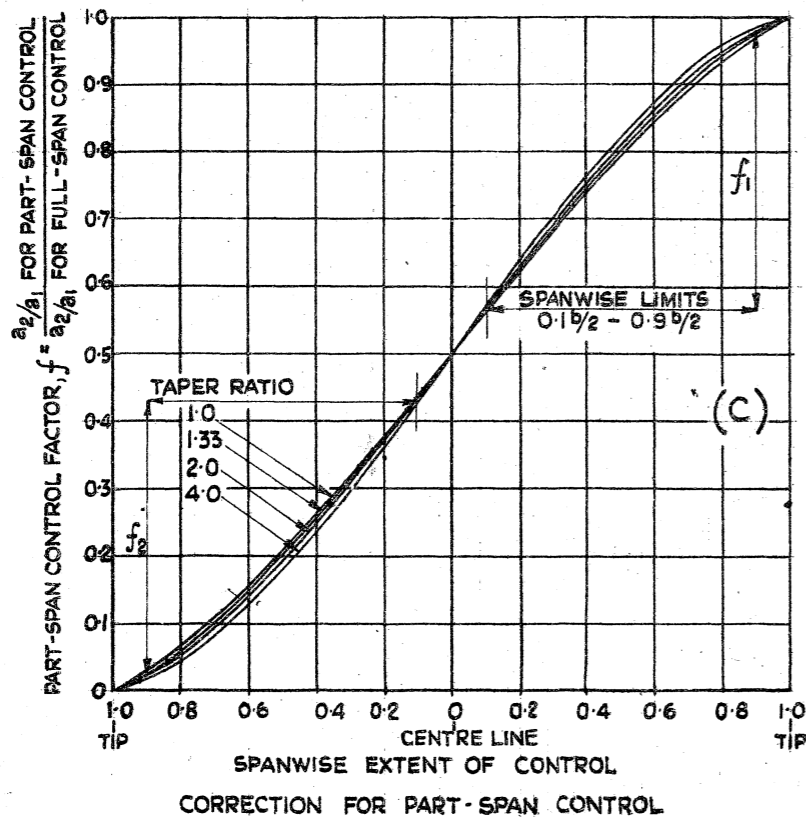

CORRECTION FOR PART-SPAN CONTROL

METHOD OF ESTIMATING a_2/a_1

① NECESSARY DATA.

- (a) TRAILING EDGE ANGLE
- (b) CONTROL CHORD RATIO = $\frac{\text{CONTROL CHORD AFT OF HINGE LINE} = C_f}{\text{TOTAL AEROFOIL CHORD} = c}$
- (c) PERCENTAGE BALANCE, NOSE SHAPE AND GAP, FOR SET-BACK HINGE
- (d) SPANWISE LIMITS OF CONTROL, & SPANWISE EXTENT OF HORN, IF ANY, EXPRESSED AS A PERCENTAGE OF THE SEMI-SPAN. (NOTE:- IF THE INBOARD END OF THE CONTROL LIES ON, OR NEAR THE SIDE OF THE BODY, IT SHOULD BE TREATED AS THOUGH EXTENDING TO THE ϕ)
- (e) TAPER RATIO

② EXAMPLE OF METHOD

CONSIDER A TAILPLANE & ELEVATOR HAVING THE FOLLOWING DATA.

- (a) T.E. ANGLE = 15°
 - (b) $C_f/c = 34\%$
 - (c) 30% BLUNT NOSE BALANCE, GAP UNSEALED
 - (d) SPANWISE LIMITS OF CONTROL $0.1b/2 - 0.9b/2$
 - (e) TAPER RATIO = 2:1
- FROM FIG. 2, $(a_2/a_1)_s = 0.61$ } HENCE $(a_2/a_1)_s \eta = 0.65$. N.B. SECTIONAL VALUE OF a_2/a_1 ,
 FROM FIG. b, $\eta = 1.07$
 FROM FIG. c, $f_1 = 0.98 - 0.57 = 0.41$. $f_2 = 0.43 - 0.02 = 0.41$
 HENCE $a_2/a_1 = [(a_2/a_1)_s \eta_1 f_1 + (a_2/a_1)_s \eta_2 f_2 + \dots] = [0.65 \times (0.41 + 0.41)] = 0.53$

CHARTS FOR ESTIMATION OF (a_2/a_1)

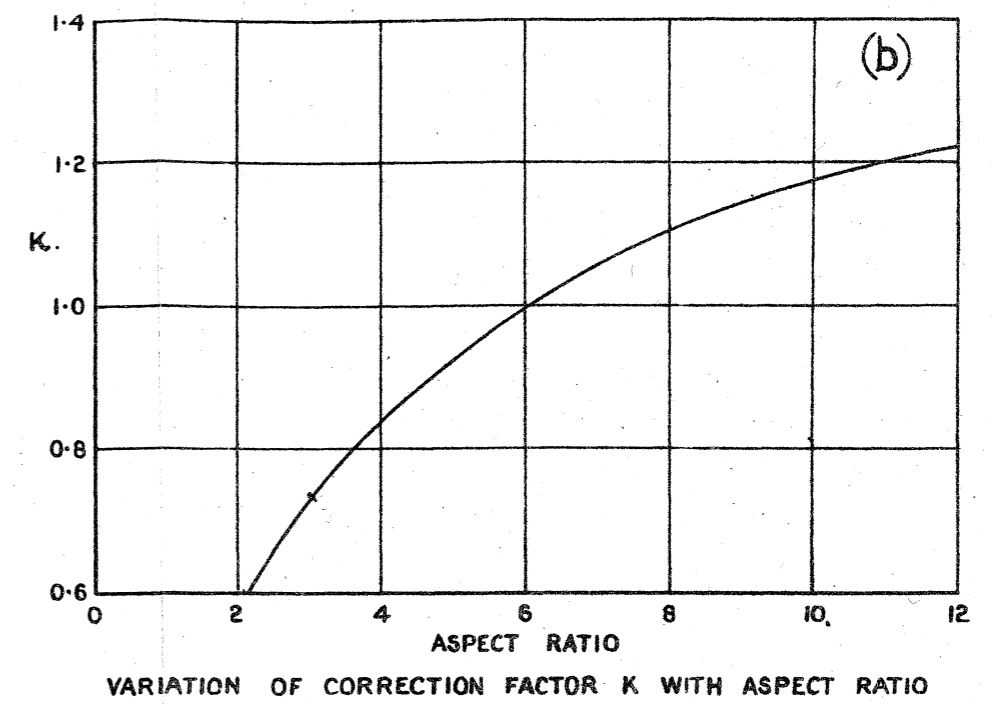
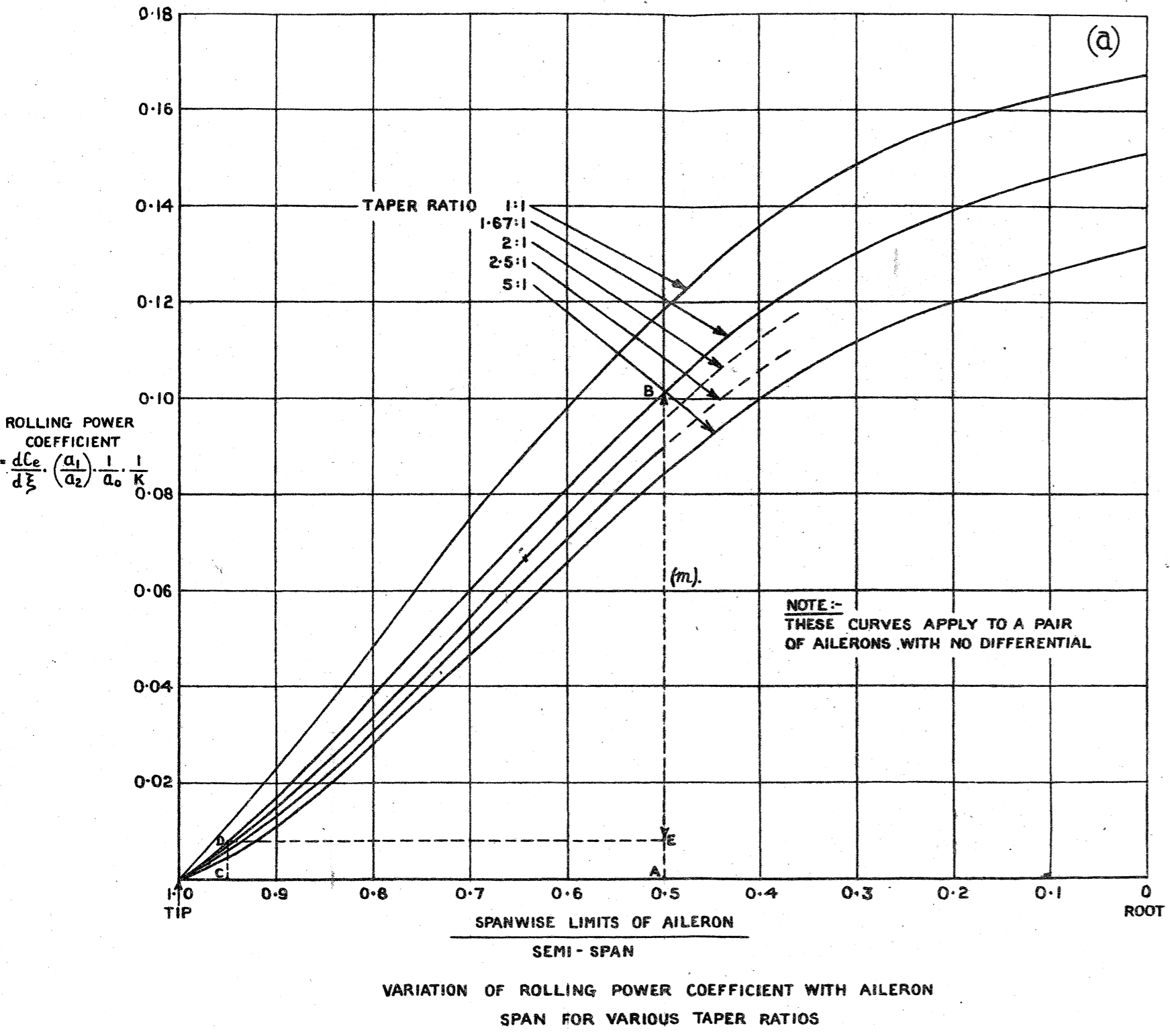

METHOD OF ESTIMATION OF ROLLING POWER

- ① **NECESSARY DATA**
- (a) AEROFOIL SECTION DATA AT MID-AILERON, TO DETERMINE a_0 (SEE FIG. 10)
 - (b) AEROFOIL SECTION DATA AT MID-AILERON, TO DETERMINE SECTIONAL a_2/a_1 (SEE FIG. 13)
 - (c) SPANWISE LIMITS OF AILERON
 - (d) TAPER RATIO OF WING
 - (e) ASPECT RATIO OF WING
- ② **EXAMPLE**
- (a) THE PERTINENT DATA ARE AS FOLLOWS :-
 - (i) WING PROFILE NACA 23012 - TRAILING EDGE ANGLE = 14.6°
 - (ii) SPANWISE LIMITS OF AILERON = 0.55 - 0.95 s
 - (iii) AILERON CONTROL CHORD RATIO = 20%
 - (iv) SET BACK HINGE BALANCE = 25% (UNSEALED GAP, ROUND NOSE)
 - (v) WING TAPER RATIO = 1.67:1
 - (vi) WING ASPECT RATIO = 7.4
 - (b) IN FIG. (a) ABOVE DRAW LINES A-B AT 0.55 & C-D AT 0.95S. THE DIFFERENCE IN LENGTH OF THESE LINES (=BE=m) GIVES THE VALUE OF $\frac{dC_l}{d\xi} \left(\frac{a_1}{a_2}\right) \cdot \frac{1}{a_0} \cdot \frac{1}{K} = 0.105$ (FOR A=6)
 - (c) FROM FIG. (b) ABOVE WE OBTAIN THE CORRECTION FACTOR FOR A=7.4, K=1.07
 - (d) FROM FIG. 10, WE OBTAIN THE VALUE OF $a_0 = 5.36$
 - (e) FROM FIG. 13, WE OBTAIN THE SECTIONAL VALUE OF $a_2/a_1 = 0.40$
 - (f) FROM § (b), (c), (d) & (e) ABOVE WE OBTAIN $\frac{dC_l}{d\xi} = 0.105 \times 1.07 \times 0.4 \times 5.36 = 0.241$ ($C_l/RADIAN$)

ESTIMATION OF ROLLING POWER

Fig. 15. ESTIMATION OF ROLLING POWER
 Corrections : Line 5 from bottom, for 0.105 read 0.093.
 Bottom line, for 0.105 read 0.093 and for 0.241 read 0.213.

(88555)

TAIL UNIT OF LOW-WING AIRCRAFT.

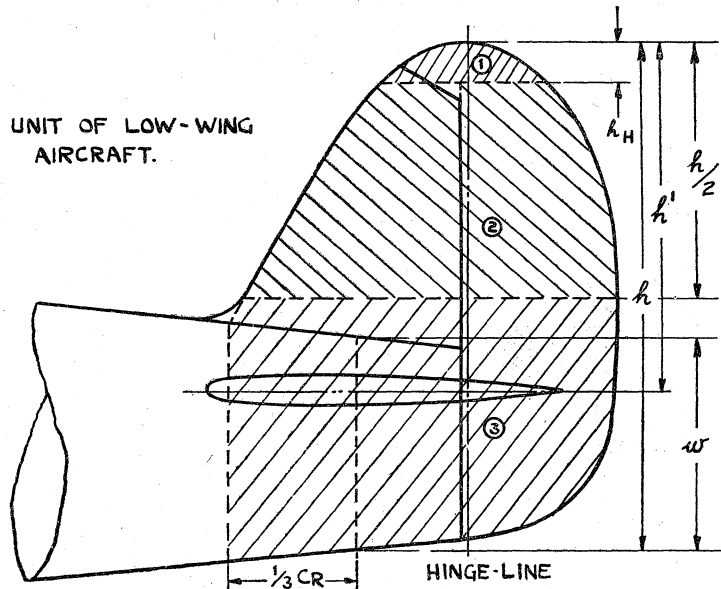

① GEOMETRIC DATA.

- (a) FIN & RUDDER VOLUME = $\bar{V} = \frac{S' l''}{S b} = 0.045$.
 (b) FIN & RUDDER HEIGHT = $h = 7.06$ FT.
 (c) DISTANCE OF TAILPLANE FROM TOP OF FIN = $h' = 4.86$ FT.
 (d) FIN & RUDDER ASPECT RATIO = 2.17
 (e) BODY DEPTH = $w = 2.92$ FT.
 (f) HORN SPAN OBTAINED BY CONVERTING FROM A PART-SHIELDED TO AN UNSHIELDED HORN OF THE SAME AREA = $h_H = 0.54$ FT.
 (g) CONTROL CHORD RATIO = $c_f/z = 42.5\%$
 (h) GAP UNSEALED, CONCENTRIC NOSE (i.e. % BALANCE = 8%)
 (i) TRAILING EDGE ANGLE = 10°

② METHOD OF ESTIMATION.

- (a) LET SUBSCRIPTS 1, 2 & 3 REFER TO THE AREAS INDICATED ABOVE. FOR UPPER HALF OF FIN & RUDDER, THE CONTROL EXTENDS FROM 0 TO $0.847 \frac{h}{2}$ & THE HORN FROM 0.847 TO $1.0 \frac{h}{2}$: FOR THE LOWER HALF, THE CONTROL IS FULL-SPAN.
 (b) FROM FIG. 13(a), $(a_2/a_1)_{S_1} = 1.0$, $(a_2/a_1)_{S_2} = (a_2/a_1)_{S_3} = 0.73$
 FROM FIG. 13(b), $n_1 = 1.0$, $n_2 = n_3 = 0.89$
 FROM FIG. 13(c), $f_1 = 0.05$, $f_2 = 0.45$, $f_3 = 0.5$.
 HENCE $a_2/a_1 = [0.05 + 0.73(0.89 \times 0.45 + 0.5 \times 0.89)] = 0.67$.
 (c) FROM FIG. 10 $a_1 = 2.75$
 (d) FROM FIG. 7 RUDDER EFFICIENCY = 90 %
 (e) FROM (b), (c) & (d), ABOVE:-
 $a_2 = 0.67 \times 2.75 \times 0.90 = 1.66$.
 (f) FROM (e) & § ①(a) RUDDER POWER = $1.66 \times 0.045 = 0.075$.

FIG. 14. Method of Estimating Rudder Power.

Publications of the Aeronautical Research Committee

TECHNICAL REPORTS OF THE AERONAUTICAL RESEARCH COMMITTEE—

- 1934-35 Vol I Aerodynamics 40s (40s 8d)
Vol II Seaplanes, Structures, Engines, Materials, etc
40s (40s 8d)
- 1935-36 Vol I Aerodynamics 30s (30s 7d)
Vol II Structures, Flutter, Engines, Seaplanes, etc
30s (30s 7d)
- 1936 Vol I Aerodynamics General, Performance, Airscrews,
Flutter and Spinning 40s (40s 9d)
Vol II Stability and Control, Structures, Seaplanes,
Engines, etc 50s (50s 10d)
- 1937 Vol I Aerodynamics General, Performance, Airscrews,
Flutter and Spinning 40s (40s 9d)
Vol II Stability and Control, Structures, Seaplanes,
Engines, etc 60s (61s)
- 1938 Vol I Aerodynamics General, Performance, Airscrews,
50s (51s)
Vol II Stability and Control, Flutter, Structures,
Seaplanes, Wind Tunnels, Materials 30s
(30s 9d)

ANNUAL REPORTS OF THE AERONAUTICAL RESEARCH COMMITTEE—

- 1933-34 1s 6d (1s 8d)
1934-35 1s 6d (1s 8d)
April 1, 1935 to December 31, 1936 4s (4s 4d)
1937 2s (2s 2d)
1938 1s 6d (1s 8d)

INDEXES TO THE TECHNICAL REPORTS OF THE ADVISORY COMMITTEE ON AERONAUTICS—

- December 1, 1936 — June 30, 1939 R & M No 1850 1s 3d (1s 5d)
July 1, 1939 — June 30, 1945 R & M No 1950 1s (1s 2d)
July 1, 1945 — June 30, 1946 R & M No 2050 1s (1s 1d)
July 1, 1946 — December 31, 1946 R & M No 2150 1s 3d (1s 4d)
January 1, 1947 — June 30, 1947 R & M No 2250 1s 3d (1s 4d)

Prices in brackets include postage

Obtainable from

His Majesty's Stationery Office

London W C 2 York House, Kingsway
[Post Orders—P O Box No 569, London, S E 1]
Edinburgh 2 13A Castle Street Manchester 2 39 King Street
Birmingham 3 2 Edmund Street Cardiff 1 St Andrew's Crescent
Bristol 1 Tower Lane Belfast 80 Chichester Street

or through any bookseller