

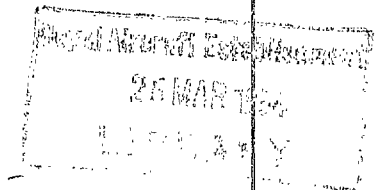

MINISTRY OF SUPPLY

AERONAUTICAL RESEARCH COUNCIL
REPORTS AND MEMORANDA



Multiple-Jet White-Smoke Generators

By

C. SALTER, M.A.,
of the Aerodynamics Division, N.P.L.

Crown Copyright Reserved

LONDON: HER MAJESTY'S STATIONERY OFFICE

1953

FIVE SHILLINGS NET

Multiple-Jet White-Smoke Generators

By

C. SALTER, M.A.,
OF THE AERODYNAMICS DIVISION, N.P.L.

*Reports and Memoranda No. 2657**
March, 1950

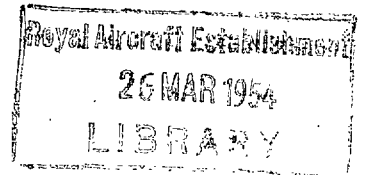

Summary.—Descriptions are given of equipment devised for the generation of fairly large quantities of an optically dense white smoke and special attention has been paid to the need for delivering this through long ducts or against an appreciable back-pressure.

The smoke consists of very small particles of condensed paraffin vapour and is obtained by directing jets of cool air on to high-speed jets of the vapour issuing from very small orifices.

The optimum outputs are about 6 cu ft (170 litres) and 8 cu ft (230 litres) per minute from No. 1 and No. 2 generators, respectively, but considerably larger quantities can be delivered with a slight loss of opacity.

Under normal operating conditions the rate of use of paraffin is rather less than 2 cu in. (33 c.c.) (No. 1) and 3 cu in. (49 c.c.) (No. 2) per minute.

1. *Introduction.*—When a jet of cool fast-moving air is directed into a high-speed jet of paraffin vapour issuing from a very small orifice a dense white cloud is obtained which is neither corrosive, poisonous, nor particularly unpleasant and which is easily photographed. Such a 'smoke' has been in use for some years¹.

The need frequently arises, however, for larger quantities than can be obtained from a single vapour jet and two generators have been built embodying a number of jets, the one 16 and the other 24.

The smoke-producing component described in R. & M. 2023, being made of Pyrex glass is essentially of a fragile nature and it has long been realised that an all-metal construction is highly desirable. Early attempts to eliminate the glass-work led to the difficulty of preventing direct conduction of heat from the paraffin evaporating component to the air tubes and to the condensed vapour. These influences vitiated the quality of the smoke at its generation and also tended to result in partial re-evaporation.

The first generator to be completed (No. 1 with 16 jets) makes use of an insulating cylinder in order to prevent excessive heat conduction. The second (No. 2 with 24 jets) is of all-metal construction and water cooling is introduced at an early stage after condensation of the vapour.

The requirements of the equipment are that it shall deliver a large quantity of smoke, sometimes against an appreciable back-pressure, and that it shall operate for long periods without over-heating and with no further attention than replenishment of the paraffin supply. It is not insisted, however, that this state has as yet been fully achieved.

* Published with the permission of the Director, National Physical Laboratory.

2. *General Arrangement and Observations.*—Fig. 1 is a photograph of No. 1 and Fig. 2a one of No. 2 generators respectively. They are slightly different from those described in the report partly for convenience and partly as a result of experience in use. The differences will be discussed later and additional suggestions will be put forward.

The layouts are illustrated in Figs. 3 to 6, while the other drawings give more detailed information. In general, the figures are drawn to scale but considerable latitude is permissible in many respects. Where, however, specific dimensions are quoted these should not be altered appreciably unless the changes are obviously not detrimental. With the assistance of the remarks in the text it is hoped that the systems will require little explanation as regards the minor details of design and construction. The apparatus is constructed mainly of brass.

In order to produce the high-speed, highly turbulent jets of vapour it is necessary to deliver the paraffin, at a moderate pressure, through a filter to a boiler where it is vaporized (Figs. 3 and 5). The vapour is then forced through orifices about 0.014 in. in diameter (No. 80 drill) into a mixing chamber (Figs. 8 and 12). The size of the smoke particles is partially dependent on the diameter of these orifices and can be modified accordingly¹.

By means of a fan or compressed air supply, turbulent jets of cool air moving at a fairly high speed are then directed on to the vapour jets (Figs. 8, 9, 12, 13). The quality and quantity of the smoke thus generated can also be adjusted to a considerable extent by altering the amount of air supplied. Severe restriction of the air, for example, results in a smoke which is extremely dense optically but at the same time very heavy.

An indicator is recommended for the amount of condensing air that is being introduced into the mixing chamber. It need only be a simple U-tube (*e.g.*, Fig. 5) measuring, in effect, the pressure drop required to develop the kinetic energy of the air jets together with incidental losses of head in the tubes.

It is also convenient to equalize the pressures in the mixing chamber and in the top part of the paraffin reservoir (Figs. 3 and 5), in order to make the height of the latter independent of the delivery pressure of the smoke, this being determined by the operating conditions at the outlet.

The condensed vapour is then passed on to a smoke reservoir and cooler (Figs. 3 and 5) where, in the one case, surplus air from the fan, by-passed by the pressure control valve, is used for cooling the smoke, and in the other case water circulation is applied.

Although an appreciable adjustment of output can be achieved by altering the rate of flow of condensing air or the current in the heater winding or both simultaneously it is necessary to make arrangements to by-pass any smoke that is not required for the work in hand and to ensure as far as possible that no choking can occur in the outlet pipes. A two-way smoke valve is used for this purpose (Figs. 4 and 6) and as an extra safeguard a relief valve should also be installed.

Sundry receivers are required for draining off any liquid that might collect in the various parts of the system especially in the starting up process although with correct handling the amount accumulated should be very small. The design must be such as to avoid air-locks as well as unnecessary pockets of liquid paraffin.

It is found that pulsations sometimes tend to build up in the generator. The cause has not yet been investigated but they are easily prevented by the insertion of a narrow-bore tube in the paraffin feed pipe.

3. *Paraffin Reservoir and Filter.*—These are sketched in Fig. 7. The reservoir is to be adjustable in height so that, if necessary, a head of about 18 in. can be maintained above the level of the orifice plate in the boiler unit. The paraffin is fed from it, through a tap and a length of rubber hose, with an inside diameter of $\frac{5}{16}$ in., to the narrow-bore pulsation-damping tube leading into the filter and thence to the bottom of the boiler. Rubber tubing in contact

with the paraffin has not yet caused any trouble but a safer alternative might be plastic tubing with an internal loose-fitting coiled spring extending its full length. The fuel gauge has been found to be a most useful adjunct. The pressure-balance connection to the mixing chamber is by ordinary rubber tubing.

In the filter, a gauze of mesh 60 to the inch should prevent anything large enough to block the orifices from passing through, but unless it can be assumed that clean paraffin will always be used it would be wise to incorporate another filter in the filling hole of the reservoir.

The photographs (Fig. 1) show that as constructed, the filter for the No. 1 generator forms the base of the boiler. It is recommended, however, that it should be kept separate, partly in order to reduce the starting-up period, partly for accessibility and partly because it then allows more flexibility in the design of the boiler.

4. *Boiler Units.*—The boiler units are illustrated in Figs. 8 and 12. The paraffin is vaporized in the vertical annular space, the top part of which will contain only vapour which is forced through the holes in the orifice plate and then enters the mixing chamber.

The wall of the boiler tube is to be $\frac{1}{8}$ in. thick, as it has been found that a thinner tube is not sufficiently robust to withstand accidental overheating. The main object of the solid centre rod is to prevent excessive ebullition. It is quite probable that, considering the question of assembly, the radial dimension of the annular space can well be made less than the $\frac{3}{16}$ in. specified. If, too, the centre rod were made of Mycalex it would assist in maintaining the highest temperature at the top of the boiler.

Any liquid that forms in the mixing chamber by condensation or entering inadvertently during the starting-up process drains away as illustrated. The drain tube should have an inside diameter of not less than $\frac{1}{4}$ in. and should be well inclined. In practice, it has also been found desirable to run a relief tube from the drain receiver to the two-way smoke valve (Figs. 3 and 5).

The insulating pillars supporting the first boiler (Fig. 11) can be made of a hard material such as cement or brick. No. 2 boiler is supported on an asbestos block.

5. *Orifice Plates.*—These are fitted to the top of the boiler tube and contain the appropriate number of holes arranged as in Figs. 9 and 13. It will be noticed in the latter figure that mutual shielding of the jets with respect to the stream of cooling air has been reduced to a minimum.

Two different schemes are illustrated in Figs. 8 and 12; in the first the solid centre rod is integral with the plate. It is important that the paraffin vapour should issue only through the fine holes and at least four (preferably six) screws should be used in order to secure the plate to the end of the tube.

The holes are about 0.014 in. in diameter (No. 80 drill) and they are to be countersunk on the inlet side (the under surface of the plate) so that the actual length of the fine bore is quite short, say about $\frac{1}{16}$ in. (see inset, Fig. 8).

The shallow cone top of the orifice plate prevents the possible formation of a pool of liquid which might interfere with the functioning of the vapour jets and complicate the starting-up process.

6. *Mixing Chamber.*—The main difference between the two units lies in the design of the mixing chamber and the associated variations in the air-feed tubes.

In the first case, each of the 16 paraffin jets has its own air jet (Fig. 9) and the walls of the chamber are made of insulating material so that conduction of heat from the boiler to the air box (and so to the condensing air) and to the upper part of the boiler unit (Fig. 8) is prevented. The air box does remain quite cool in use. The lead-off pipe, however, becomes warm because of the latent heat of the paraffin vapour which is inevitably carried into the smoke.

The natural angle of both air and paraffin jets being about 20 deg, the alignment of the air and vapour holes is not very critical.

In the second generator the air supply to the 24 jets is by two narrow slots (Figs. 12 and 13) and the walls of the mixing chamber are made of brass, which is as thin as possible, so that the transfer of heat by conduction is limited. The metallic connection with the air tubes is also restricted and in use they remain quite cool except very near the slots.

The height of the air holes above the orifice plate does not appear to be very critical but the axis of the air jets should be of the order of $\frac{1}{2}$ in. above the orifices.

The bolted flanged joint adjacent to AA (Fig. 12) is introduced in order to facilitate cleaning the jets with a fine wire if it is required. This, however, is rarely necessary.

The side tubes (Figs. 12 and 13) and the corresponding side tubes in the lead-off pipe in Fig. 8 are connected to the top of the paraffin reservoir and the U-tube respectively, by ordinary rubber tubing.

7. *Construction of Insulating Cylinders.*—As a temporary measure the experimental cylinders originally used were cast from a mixture of 3 parts by weight of Sillimanite and one of cement fondu which was passed through a 50-mesh screen and thoroughly dry-mixed. Fig. 16 gives the essential details of the moulding box. When partially dry the castings can be turned to the correct dimensions. In fact the air holes can actually be drilled out but not without considerable care.

These cylinders have been found to be completely satisfactory. The permanent arrangement, however, consists of a set of five Mycalex rings, three being 1 in. thick and the two end ones $\frac{1}{2}$ in. thick. (It appears to be impossible to obtain complete cylinders at present). The centre ring is drilled with 16 partially tapered holes as illustrated. The rings are then dowelled together and all joints are sealed with paper gaskets and jointing cement, except for the asbestos sheet (without jointing cement) on top of the uppermost ring.

The whole of the No. 1 boiler unit is held together by four vertical rods screwed into the base plate (Figs. 1 and 8).

8. *Condensing Air Indicator and Size of Air Holes.*—The flow of condensing air is indicated by the U-tube in the form of the pressure drop from the air junction box to the mixing chamber (Figs. 4 and 5). It must of course be calibrated if it is desired to obtain the exact relation between quantity of condensing air and head of water, but in practice the best range of indication, which is found to be roughly proportional to the square of the quantity, can be found by visual observation during the first trials.

The requisite length of U-tube will depend on the diameter of the air holes. A working length of 20 in. should be ample and this can of course be shortened by the use of a liquid heavier than water.

It is desirable to ensure that the air entering the mixing chamber shall be moving at a fairly high speed, in the order of 200 ft/sec. On the other hand, as much of the pressure head of the fan is absorbed in developing kinetic energy in the air jets, and as a margin is required for back pressure at the final delivery point, it is necessary to set a suitable limit and for this reason the size of the air holes may be fairly critical.

In the insulating cylinder of the apparatus shown in the photographs (Fig. 1) the air holes have been finally opened up with a 0.096 in. drill so that the diameters lie between 0.096 and 0.1 in. In this case the U-tube reading is 7 in. head of water for a flow of 6 cu ft/min., approximately. With holes 0.08 in. in diameter the reading would be roughly 11 in.

Where the pressure available is sufficient, bearing in mind the margin required in operation, it is recommended that the smaller size should be chosen, or better still a diameter of 0.075 in. The parallel length is about $\frac{1}{8}$ in.

In the No. 2 generator each slot is to be approximately 1 in. long and $\frac{1}{16}$ in. wide.

9. *Fans and Pressure Control Valves.*—The vacuum cleaner fan of Fig. 1 has an impeller diameter of $4\frac{1}{2}$ in. and, at low volume deliveries, runs at 12,000 r.p.m. It then develops a pressure head of about 12 in. of water so that the margin for overcoming back-pressure at the smoke exit is not large (see section 8).

Consequently the second generator has been fitted with a three-stage fan (also of standard vacuum cleaner design) developing 33 in. water gauge. It is encased in a cylindrical housing tapering off at one end to a 2-in. outlet tube. In this case the pressure is controlled by a loose slotted sleeve adjustable to cover, wholly or partly, a similar slot in the outlet tube (Figs. 5 and 6). As water cooling is employed in this case the surplus air is not required for cooling the smoke.

A convenient pressure control valve for the No. 1 generator is illustrated in Fig. 10. It slips over the fan outlet and, by a single movement, controls the pressure and quantity of the air supply to the mixing chamber, while at the same time it passes on the surplus for cooling, prevents any stalling of the fan and has in itself a fairly high efficiency. Stops are fitted to suit the range of movement (90 deg is sufficient), only the cooling air aperture being subject to restriction.

If a three-stage fan should be used (Fig. 16) the stops are to be located so that either aperture can be throttled.

10. *Air Junction Boxes.*—These are merely a convenient means of assisting the uniform distribution to the mixing chamber of the air required for condensation of the paraffin vapour. They are sufficiently illustrated in Figs. 10 and 13.

All connecting tubes in the air-feed system are of fairly large diameter in order to reduce incidental losses of pressure, and sharp bends are avoided as far as possible.

11. *Air Box—No. 1 Generator.*—In order to feed the condensing air fairly uniformly to the 16 tapered air holes the air box illustrated in Fig. 9 is clamped round the insulating cylinder. Drain pipes are fitted in case liquid paraffin should accidentally run back through the air holes but it is found in practice that this is not likely to occur, so that if desired, the corresponding drain receiver may be eliminated and a couple of taps fitted to the drain tubes instead.

As a further simplification it should be fairly easy to design an equally effective air box in the form of a volute thereby eliminating the need for the junction box and multiple connecting tubes.

12. *Air Tubes—No. 2 Generator.*—The tubes connecting the air junction box to the air slots are made of thin walled copper and are specially bent and shaped as illustrated in Figs. 13 and 14. The tubes are also bent in such a way as to permit any liquid paraffin that might accidentally flow into the slots to leak away immediately. In practice this trouble has never occurred but it is not desirable to avoid provision for draining the tubes.

The copper tubes on the prototype generator have an inside diameter of $\frac{5}{8}$ in. and a wall thickness of 0.02 in. Bending is not difficult if they are first filled with lead, resin, pressed sand, etc., or with one of the proprietary products. In Fig. 13, the tube diameter is given as $\frac{3}{4}$ in. outside diameter in order to provide a slightly longer slot. The latter is to be about $\frac{1}{16}$ in. wide and should be inclined slightly upwards so as to assist the free flow of the mixture to the cooler.

13. *Cooler and Smoke Reservoir.*—Sketches of the coolers, which are also to some extent smoke reservoirs where the turbulence dies away and the larger particles settle out, are given in Figs. 11 and 14. In each case, as drawn, the smoke enters the cooler at the top and passes out to the smoke valve at the lower end but modifications to this will be discussed later.

Connections to the smoke connecting tube and thence to the lead-off pipe above the mixing chamber are by reinforced rubber hose. This is for insulation against conducted heat. No trouble has been experienced in the use of rubber hose in these positions but they may require replacement at long intervals.

14. *Two-Way Smoke Valve*.—In order to ensure as far as practicable that the operation of the generator shall not be affected by variations in the amount of smoke required for the work in hand, or by constrictions in the delivery pipes, a two-way smoke valve (Figs. 11 and 15) is introduced. Rotating the inner cylinder by-passes unwanted smoke to a safe place and, with simultaneous adjustment of the pressure control valve, enables the delivery pressure to be varied over a wide range.

Stops are fitted to limit the range of movement of the rotating part and a suitable drain pipe is required,—sometimes also in the pipes leading away from the valve to the final outlet.

It has been found a little difficult to prevent leakage of smoke from the original two-way smoke valve (Fig. 11), and it is proposed that a lid should be added holding a hard felt sealing washer as shown in Fig. 15. There are other possible types of valves but the design should be such that there is always a path for the smoke either through the operating circuit or to free air through the by-pass tube. It is also normally desirable to be able to make use of the full available pressure head of the fan when required and this involves some precision of manufacture.

15. *Drain Receivers*.—A sketch of a typical receiver is given in Fig. 10. The transparent ends are highly advantageous and assist in indicating correct operation of the equipment, when there should be no flow of liquid from the mixing chamber and air box in particular.

Connections are by $\frac{1}{4}$ -in. inside diameter copper tubes and pipe unions.

16. *Heater Windings*.—The boiler cylinder is first wrapped with four layers of mica sheet, each 0.002 in. thick, which are clamped in position by a metal band at each end (Figs. 8 and 12). These clamps hold the ends of the coil and the leads are taken out through strings of fish-spine beads.

The generator of Fig. 1 has a heater consisting of 41 turns of No. 22 s.w.g. Brightray wire tightly wound and spaced as shown in the figure in order to maintain the greatest temperature at the top and so prevent excessive ebullition. The resistance of the coil is about $16\frac{1}{2}$ ohms and its length (including two 6 in. leads) is 225 in.

This wire will carry a current of 8 amperes with safety but the normal operating current may be as low as 6 amperes (600 watts). It is immaterial whether a.c. or d.c. is used but if the supply is a.c., the heater is conveniently fed from an auto-transformer. An ammeter is required in series with the coil.

Where the apparatus is to be used on 230 volt mains the winding should consist of 385 in. (total length) of No. 26 s.w.g. Brightray wire spaced 16 turns to the inch. The total resistance will be about $67\frac{1}{2}$ ohms giving a maximum current of 3.4 amperes (780 watts) and a resistance in series, of about 10 ohms, should be inserted for adjustment.

In the No. 2 Generator the 230 volt heater coil consists of 420 in. of No. 24 Brightray wire corresponding to about 68 turns with 6 in. or so of loose lead at each end, insulated as before with fish-spine beads. Winding is commenced at the top clamp allowing 16 turns to the inch. The total resistance is rather more than 49 ohms and the maximum current is nearly 4.7 amperes (1050 watts in the coil). A 10-ohm resistance in series is adequate for control and an ammeter reading up to 5 amperes is desirable.

A thick layer of heat-insulating material (1 in. or more) is required and it is made easier to lag the closely spaced winding without danger of short circuits if a thin layer of ceramic cement is first applied and left to dry.

There is ample room on the base-plate for switches, rheostats, etc., but, especially in the case of the air-cooled unit, the rheostat should certainly be located so that it does not interfere with the cooling system.

17. *Operation.*—With the free paraffin surface in the reservoir 2 in. below the level of the orifice plate, the smoke valve open to the by-pass side and the pressure control valve set for a moderate flow of condensing air, current is passed through the coil until the vapour jets are heard to be coming into action. This will take 5 to 10 minutes with initial currents of $7\frac{1}{2}$ amperes (No. 1 Generator as wound), 3·4 amperes (No. 1, 230 volt winding) and 4·7 amperes (No. 2).

The fan is then switched on and the paraffin reservoir slowly raised; at the same time the condensing air supply is increased to a maximum consistent with a good smoke. The reservoir is to be as high as possible, with the proviso that liquid paraffin is not to get through the orifices and so drain off from the mixing chamber. Only experience will show what this level should be, and how rapidly the reservoir can be raised. It is instructive to examine what happens at the surface of the orifice plate when this process is applied, and the surface can be exposed by removing the superstructure, but with the fan left out of action.

At this stage, if the equipment is to be used for a long period (say more than 30 minutes), the water cooling should be applied to the No. 2 Generator.

The apparatus becomes thoroughly warmed up in 10 or 20 minutes and in this period the heating current should be reduced as much as possible. This may be only 6 amperes (No. 1 as wound), 3 amperes (No. 1, 230 volt winding) and 4 to $4\frac{1}{2}$ amperes (No. 2). At the same time the reservoir may have to be lowered and the amount of condensing air adjusted. The current, paraffin level and U-tube readings should all be noted for future reference.

In order to deliver smoke to the site where it is to be used the partial or complete changeover of the smoke valve is to be combined with an adjustment of the pressure control valve so as to maintain the same reading on the U-tube, thereby allowing for the back-pressure in the delivery pipe.

The sequence of shutting down the plant is to open the smoke by-pass, lower the paraffin reservoir and switch off the heating current. The fan can well be left running for a short while in order to clear the remains of the smoke.

18. *Operating Data.*—Under normal operating conditions the rate of use of paraffin is rather less than 2 cu in. (No. 1) and 3 cu in. (No. 2) per minute.

Some physical properties of ordinary paraffin are as follows:—

Distillation range 140 deg C to 285 deg C.

Specific heat of liquid

0·48 calories per gram per deg C at 20 deg C.

0·51 " " " " " " " 60 deg C.

0·57 " " " " " " " 140 deg C.

and of the residual carbons at the top end of the distillation range

0·65 calories per gram at 250 deg C.

Latent heat of vaporization

59·9 calories per gram at commencement

and 42 " " " " " " " end of distillation.

Specific heat of vapour

0·49 calories per gram per deg C at 200 deg C.

19. *Safety Precautions.*—It is not easy to avoid accidental spillage of paraffin from time to time and as a precaution against fire risk it is suggested that the apparatus be set up on a rigid base plate and lowered into a lidless metal box. In order to allow easy removal for occasional operational attention, such as emptying the drain receivers where accessibility is otherwise

inadequate, handles can easily be attached to the base. In this case it is preferable that the switches and rheostat should be outside the box with a plug and socket coupling for the heater and fan leads.

An explosion resulting from a fortuitously correct mixture of paraffin vapour and air has always been regarded as a possibility, but extensive use of the apparatus under a variety of conditions seemed to show that this was unlikely. At last, however, an occasion arose when the heater was left switched on for a considerable time with the fan not in use. An explosion then took place which blew out the end of the cooling cylinder which had been sweated into the main tube (No. 1 cooler).

This incident gave a clue to the type of safety valve to employ, *i.e.*, a large aperture valve which opens quickly and is situated near the main concentration of hot mixture.

A design is shown in Fig. 15 incorporated in the two-way smoke valve of No. 2 generator. The lid is held in place by three springs which are normally just strong enough to ensure good sealing with the felt washer. Because of the pressure drop in the air slots the normal working pressure in the smoke valve is always less than the maximum fan pressure. The latter is 33 in. water gauge, *i.e.*, 1.2 lb sq in. or 15 lb total on the lid.

If, therefore each spring has a tension of the order of 5 lb, there should be a fair margin for sealing against leaks. If also the extension associated with this load is large the extra extension due to undesirably large pressures in the smoke valve will be correspondingly large, thereby increasing the rapidity with which the apertures in the inner movable cylinder are exposed to free air.

It is necessary to arrange pins and slots in such a position as to prevent rotation of the lid in normal use.

Details of the steel springs in use are as follows:—

| | |
|------------------------------------|-----------------------|
| Diameter of wire | 0.064 in. (16 s.w.g.) |
| Number of turns | 41 |
| Mean diameter of coil | 0.55 in. |
| Unstretched length of coil | 2.7 in. |
| Extension per lb | $\frac{3}{16}$ in. |

If such a device is incorporated in the first design it can be made to replace the rubber hose couplings of the smoke connecting tube.

20. *Concluding Remarks and Possible Modifications.*—While the report describes smoke generators which, in their essential details, have been found to be perfectly satisfactory, numerous variations can be suggested which would lead to constructional simplicity or to the use of apparatus ready to hand, *e.g.*, fans and filters. At the same time it might be useful to suggest other modifications that have not yet been examined some of which might lead to improved efficiency.

(a) It will be noticed that the water cooler of the photograph (Fig. 2a) is, unlike the design illustrated in Fig. 5, set up vertically above the boiler. There are two reasons for this. First, the soft felt originally inserted for sealing the lid of the smoke valve was not entirely leak proof against the paraffin liquid, and secondly, it was desired to consider whether the bent smoke connecting tube was detrimental to the quality of the smoke. It is considered that a definite improvement was obtained but an intermediate position can be recommended in order to simplify the problem of achieving compactness, sealing the lid, and keeping the cooler away from the stream of hot convected air rising from the boiler.

(b) The question of whether bends should be eliminated from the smoke tubes is associated with the problem of cooling and the choice of high or low-speed transmission to the delivery point. Turbulent flow will of course lead to more rapid cooling but probably at the cost of

excessive condensation on the walls. It is now considered that the best method of cooling is by radiation, so that the turbulence generated by the jets should be allowed to dissipate quickly, the incidence of further turbulence limited by low speeds of smoke transmission and sharp bends in the ducting avoided wherever it is convenient.

(c) The two designs are based on the assumption that compactness is a desirable feature, but it has been found that this is not always important. If, in such cases, the equipment is modified after the style of Fig. 2, the smoke reservoir (which is the inside tube of the cooler in No. 2 generator) might be made the same diameter as the two-way smoke valve and connected to the mixing chamber by a section of tube shaped in the form of the frustum of a cone, the lower end being about 2 in. and the upper 4 in. in diameter.

Also, in the No. 2 design, the lower part of this conical piece might be placed fairly close to the slots (dotted lines of Fig. 12) with the object of reducing the incidence of a scrubbing effect of the smoke on the walls of the mixing chamber.

In the present stage, this still leaves right-angled turns in the two-way smoke valve, but it is easy to incline the outlet tubes if desired, or even to maintain a nearly straight flow by suitable modifications of design while still incorporating a safety valve based on the principles discussed in section 19.

(d) There are occasions when the whole of the smoke output is always required in a permanent arrangement of the plant, as in a long chimney. In these cases it will often be possible to dispense with the cooler and rely on natural cooling of the ducting, which will be rendered more effective by a moderate inclination of the latter to the vertical.

(e) While this report was being written the possibility of using an oil immersion heater was examined. A photograph of the heater used is reproduced in Fig. 2b. The rated power of the element is 500 watts (230 volts) and the depth of immersion is about 6 in. This has been incorporated in an experimental boiler with a covering of ceramic cement 1 in. thick on the outside, and has been found to be amply powerful enough even for a 24-jet orifice plate. It appears that the power input can be reduced to roughly one half in this way and the construction is also simplified.

REFERENCES

- | <i>No.</i> | <i>Author</i> | <i>Title, etc.</i> |
|------------|----------------------------------|--|
| 1 | J. H. Preston and N. E. Sweeting | .. An Improved Smoke Generator for Use in the Visualization of Air Flow, particularly Boundary-layer Flow at High Reynolds Numbers. R. & M. 2023. October, 1943. |
-

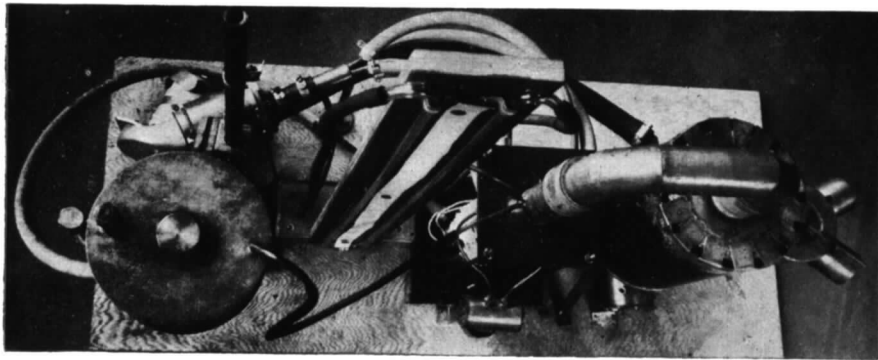
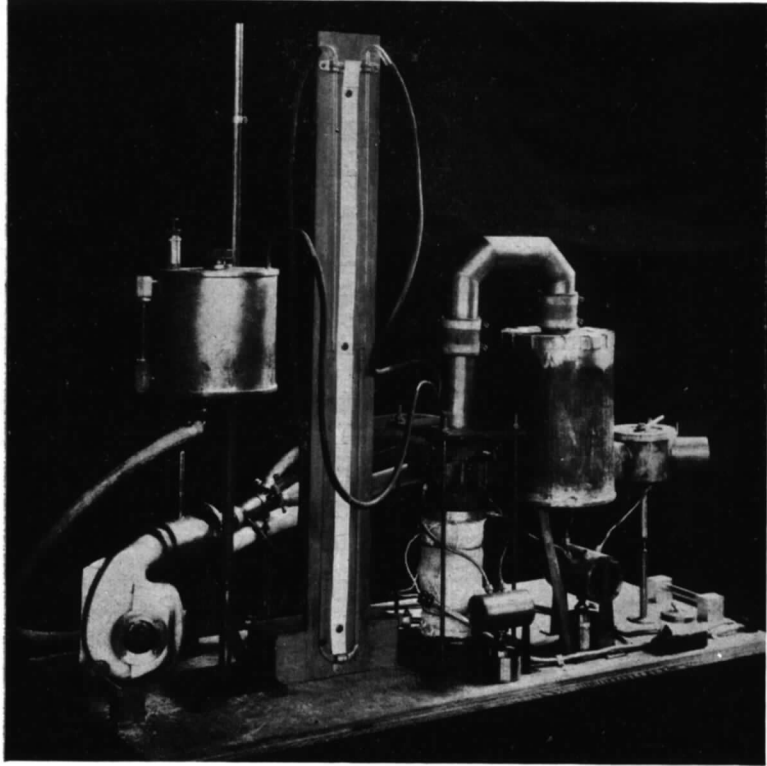

FIG. 1.

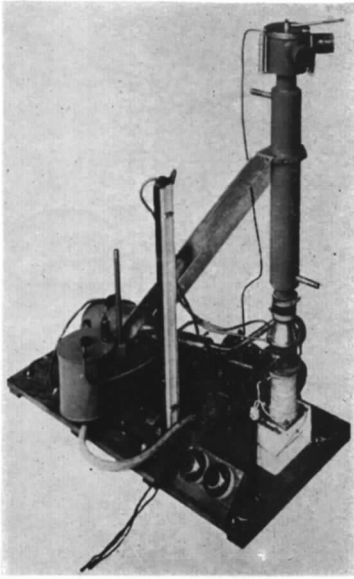

FIG. 2a. No. 2 Generator.

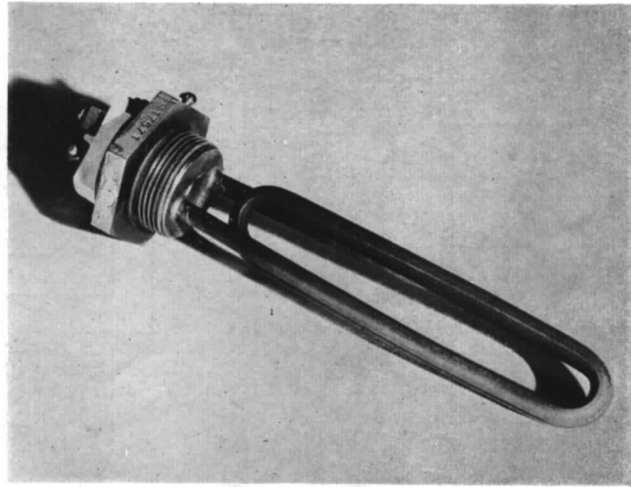

FIG. 2b. 500-watt immersion heater.

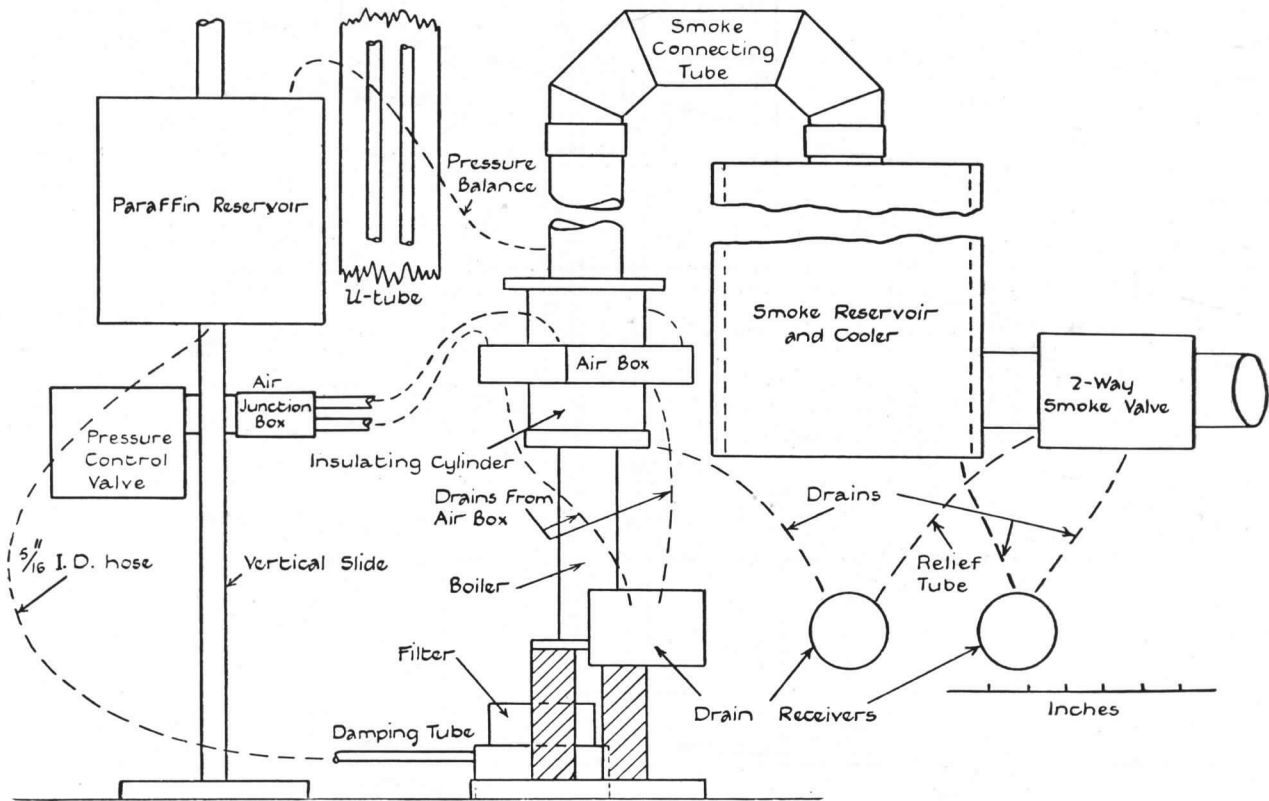

FIG. 3. General layout in elevation. No. 1 generator.

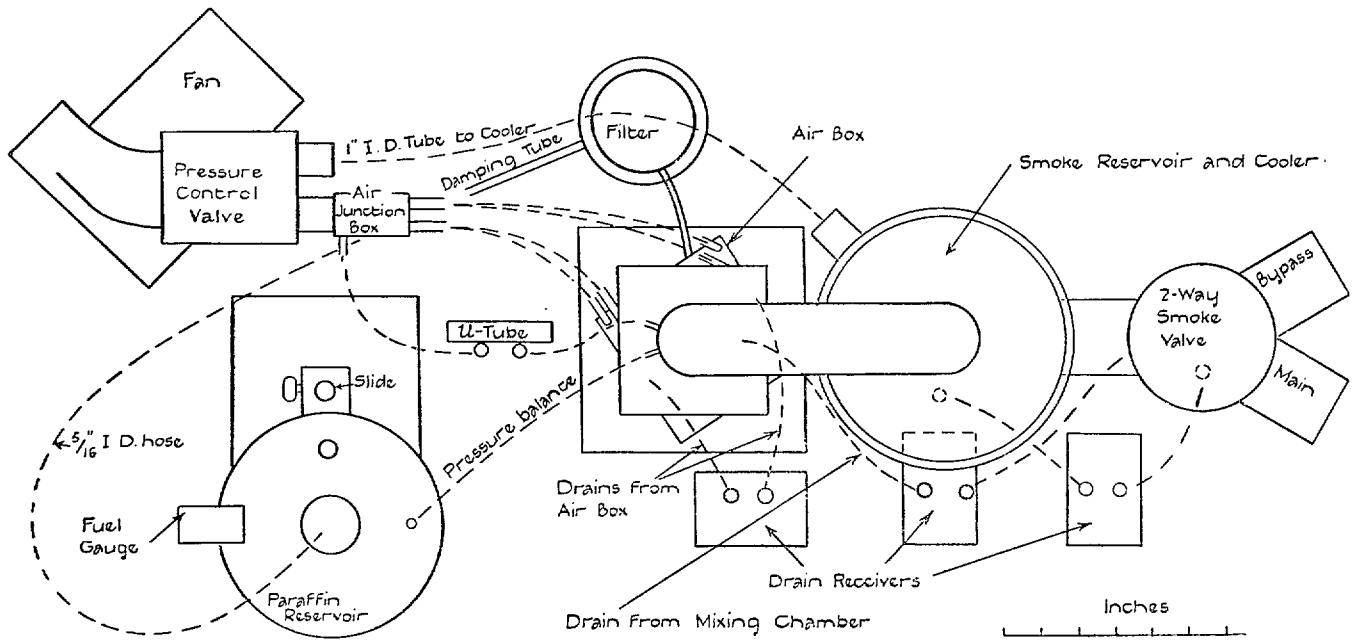

FIG. 4. General layout in plan. No. 1 Generator.

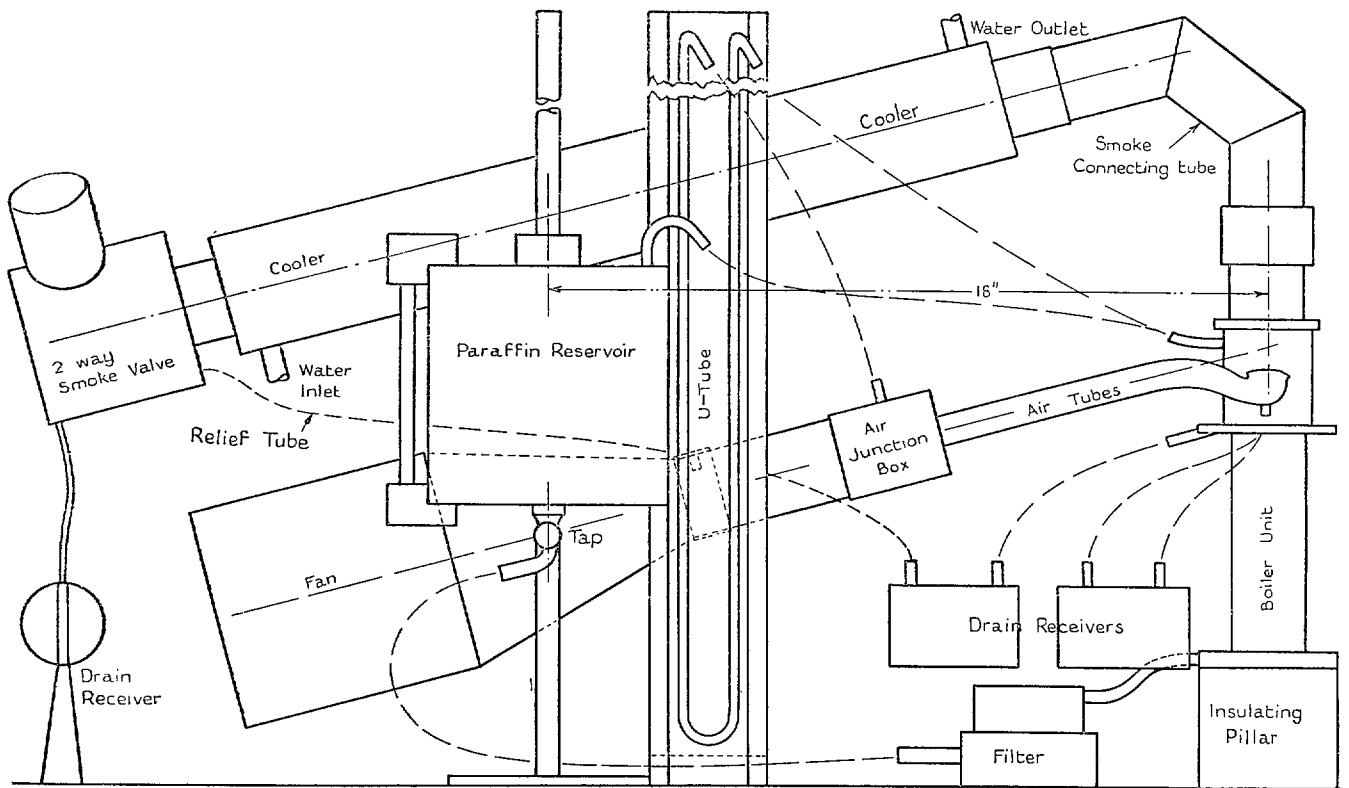

FIG. 5. No. 2 multi-jet white-smoke generator. Elevation.

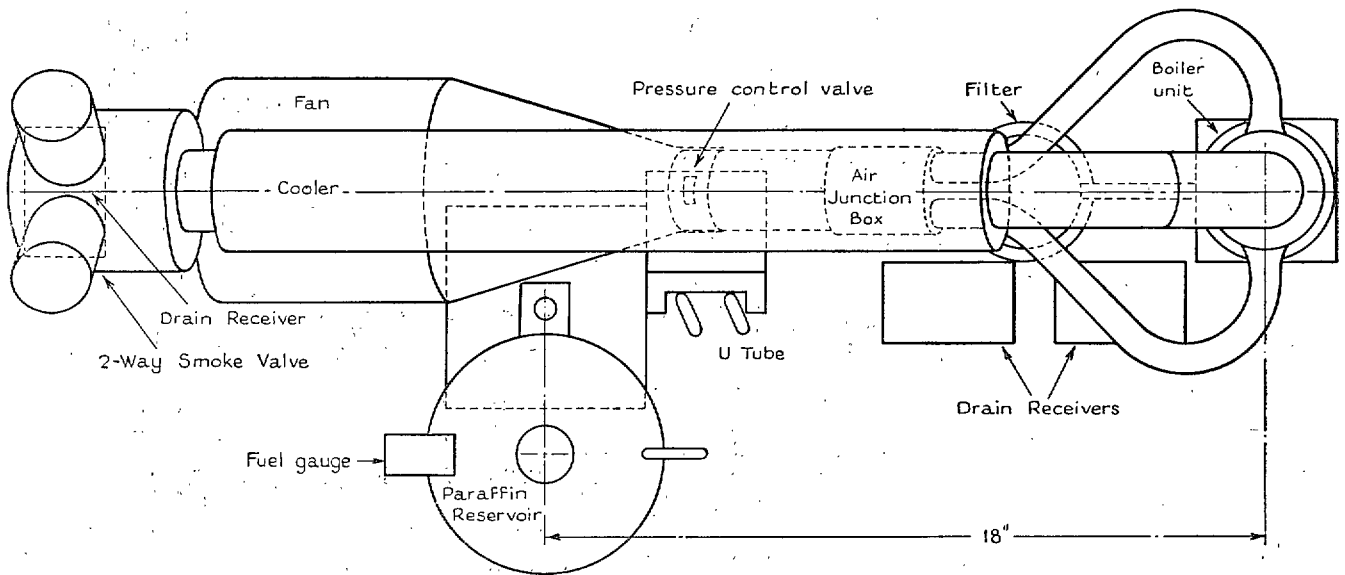

FIG. 6. No. 2 multi-jet white-smoke generator (Plan).

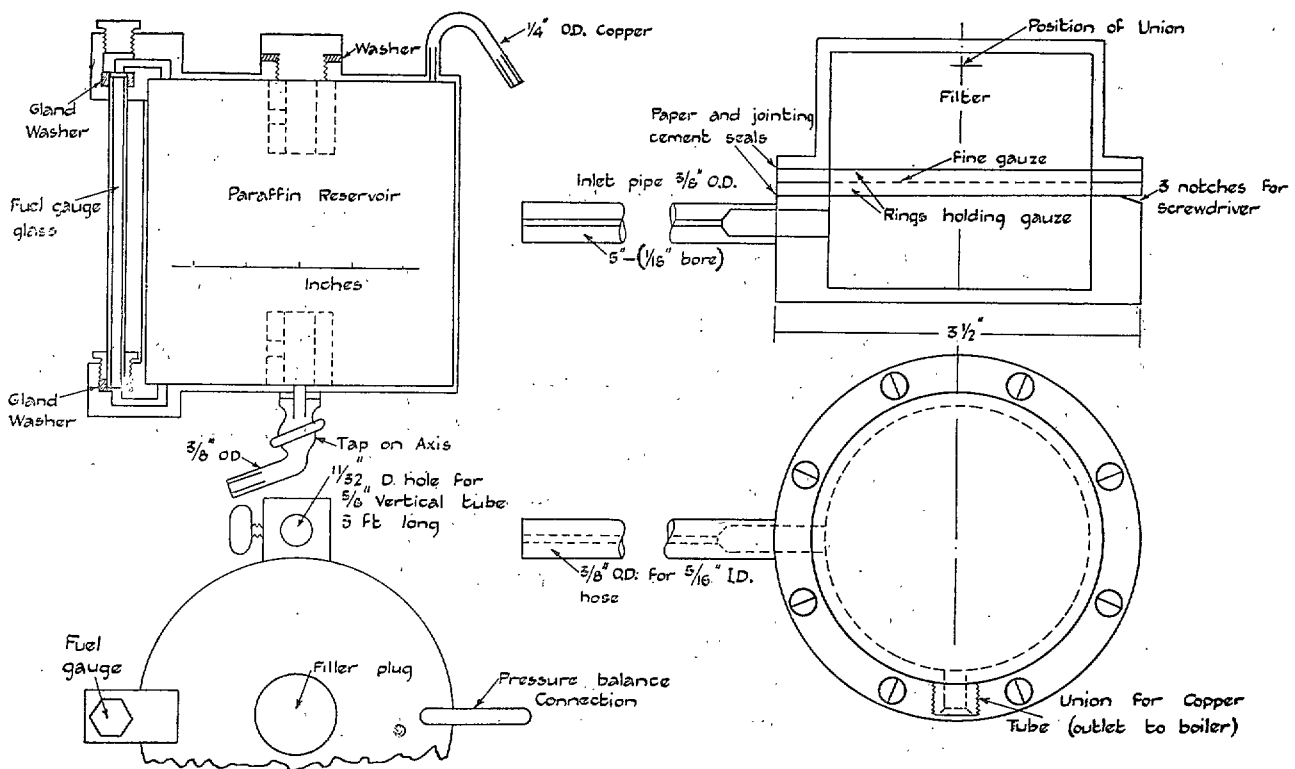

FIG. 7. Paraffin reservoir and filter.

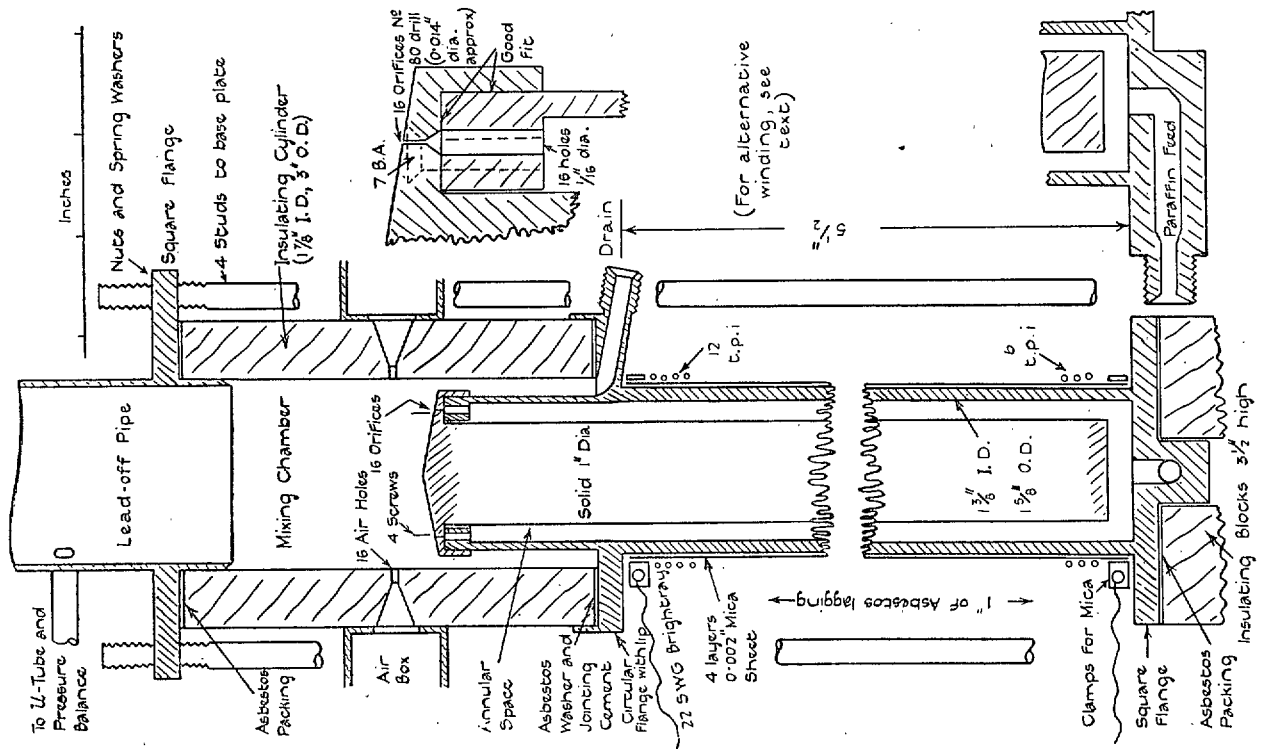

FIG. 8. Boiler and mixing chamber. No. 1 generator.

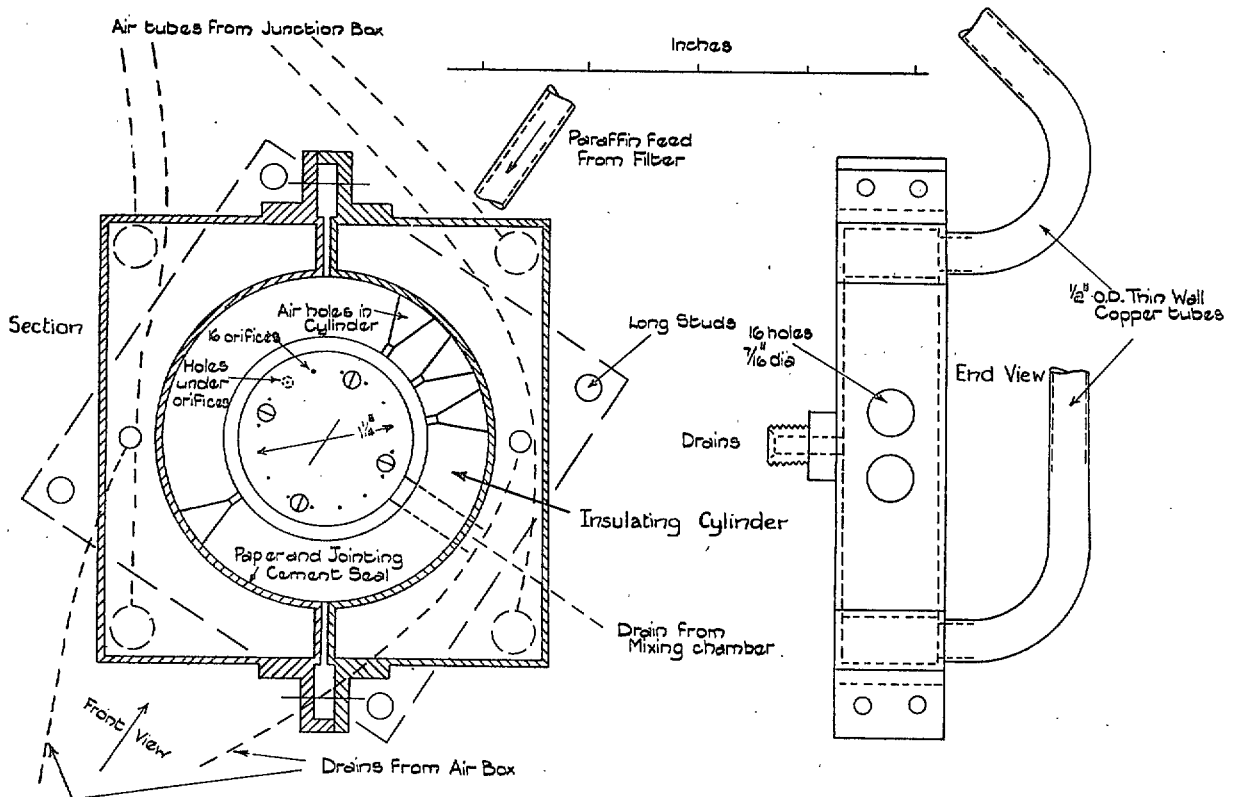

FIG. 9. Air box and orifice plate. No. 1 generator.

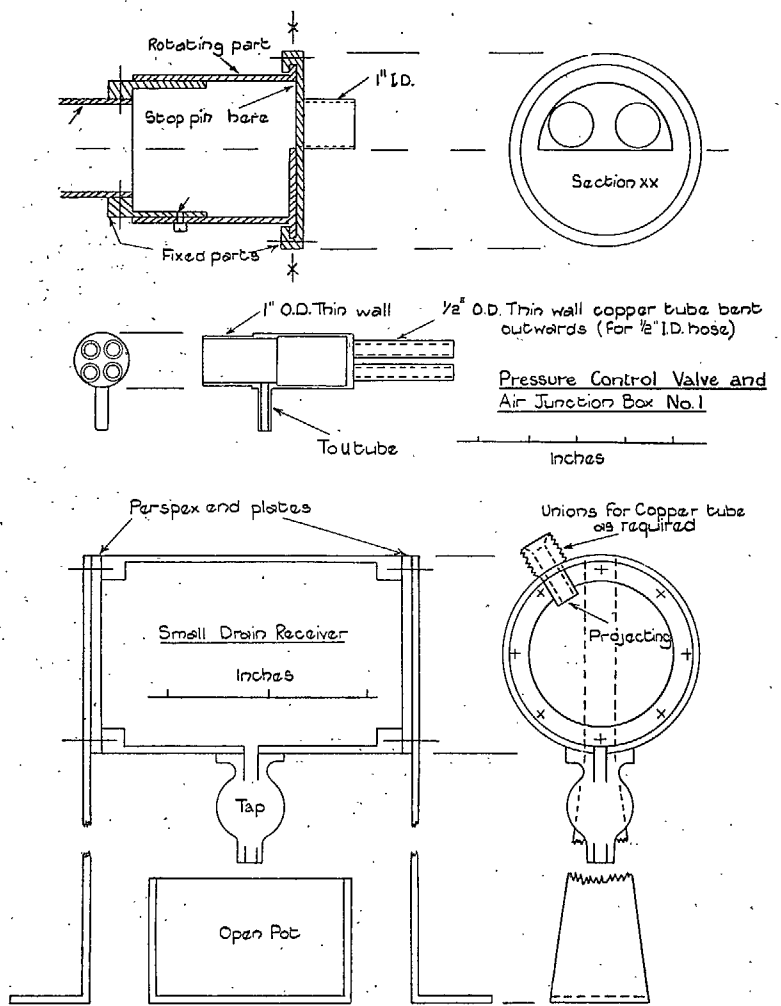

FIG. 10. Air distributors and drain receivers. No. 1 generator.

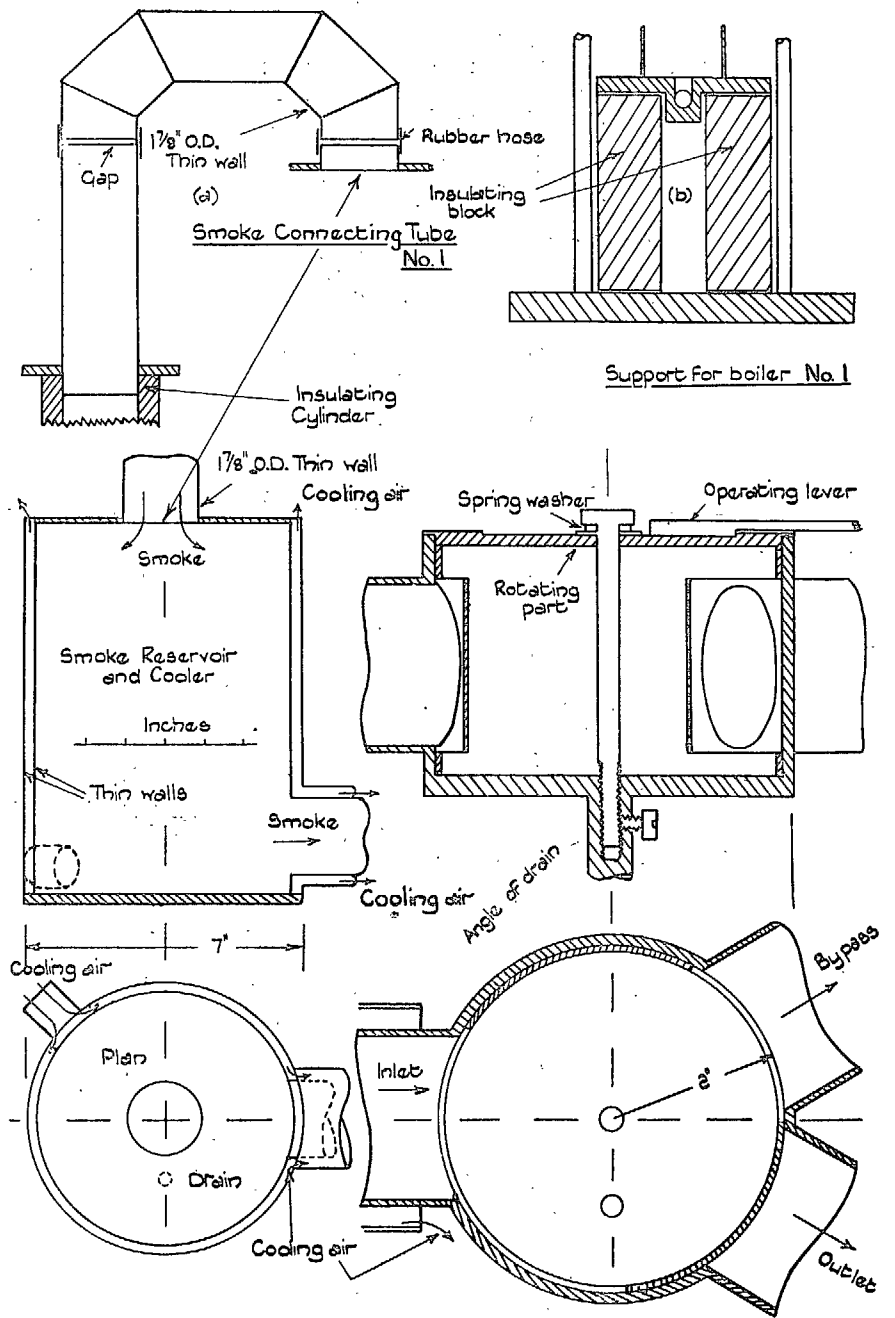

FIG. 11. Smoke reservoir and two-way smoke valve. No. 1 generator.

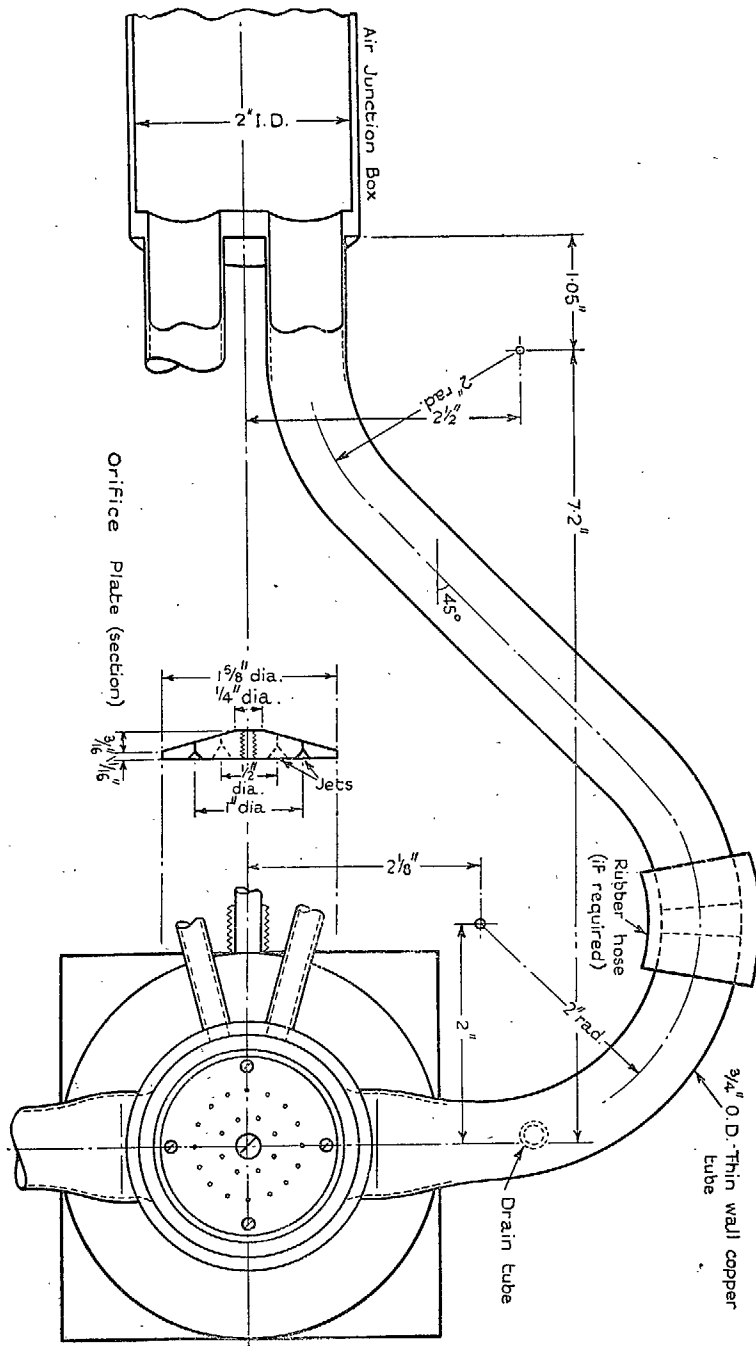

FIG. 13. Plan view of boiler unit, air tubes and orifice plate. (Section AA, Fig. 3).

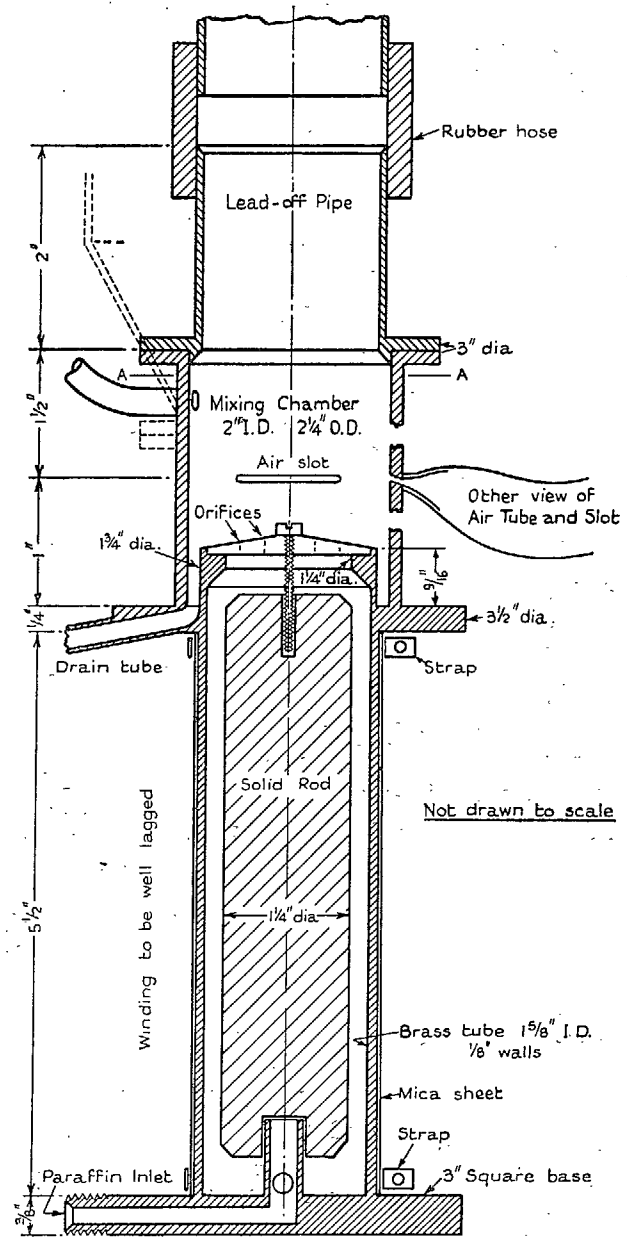

FIG. 12. Sectional drawing of boiler unit No. 2 generator.

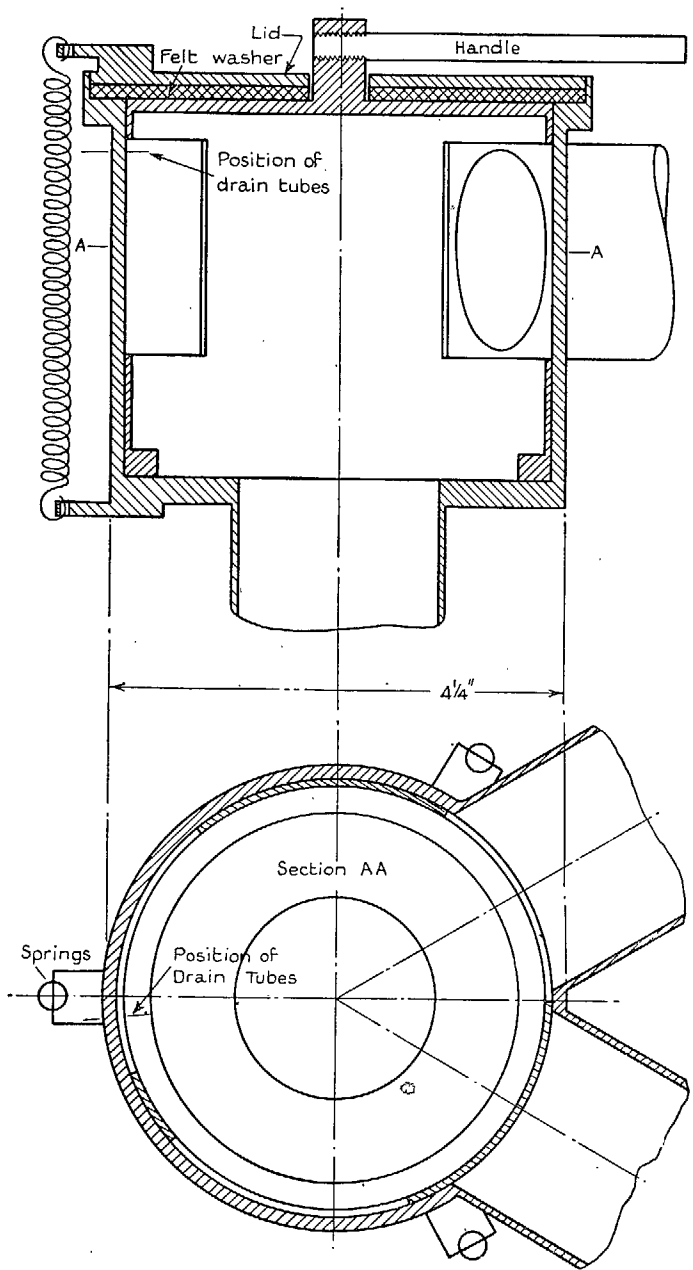

FIG. 15. Two-way smoke and safety valve.

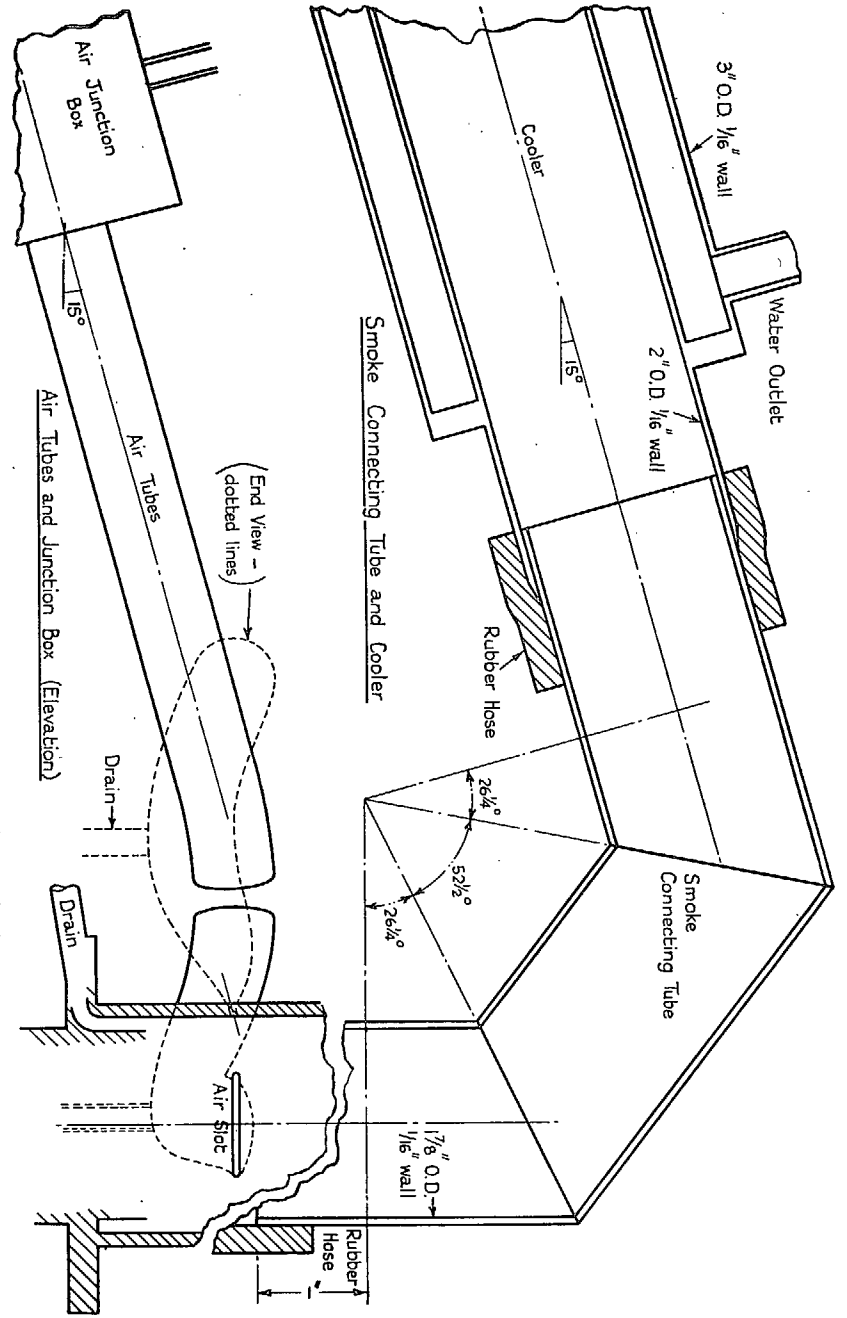

Fig. 14. Air tubes and junction box (elevation).

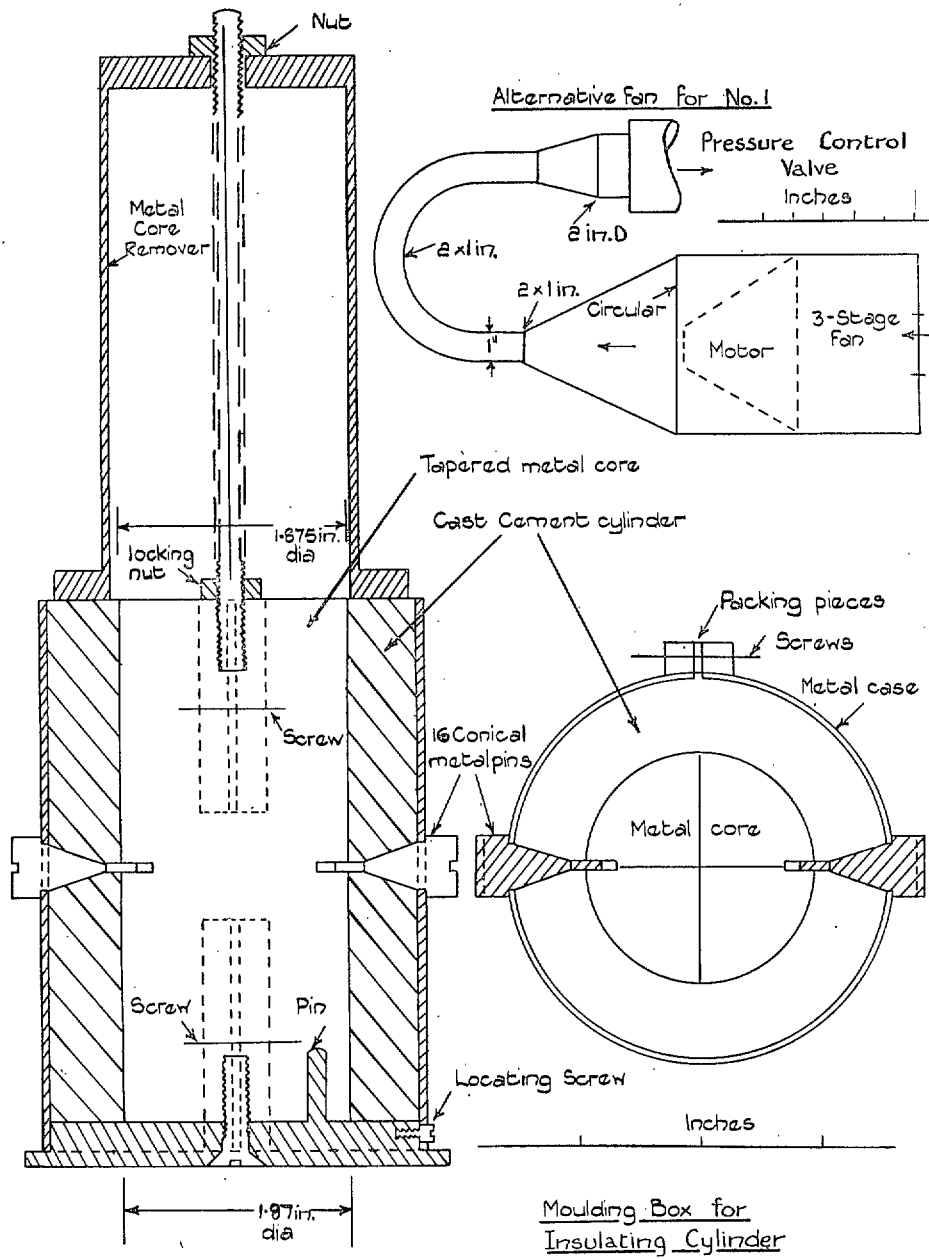

FIG. 16. Moulding box for insulating cylinder.

Publications of the Aeronautical Research Council

ANNUAL TECHNICAL REPORTS OF THE AERONAUTICAL RESEARCH COUNCIL (BOUND VOLUMES)

- 1936 Vol. I. Aerodynamics General, Performance, Airscrews, Flutter and Spinning. 40s. (40s. 9d.)
 Vol. II. Stability and Control, Structures, Seaplanes, Engines, etc. 50s. (50s. 10d.)
- 1937 Vol. I. Aerodynamics General, Performance, Airscrews, Flutter and Spinning. 40s. (40s. 10d.)
 Vol. II. Stability and Control, Structures, Seaplanes, Engines, etc. 60s. (61s.)
- 1938 Vol. I. Aerodynamics General, Performance, Airscrews. 50s. (51s.)
 Vol. II. Stability and Control, Flutter, Structures, Seaplanes, Wind Tunnels, Materials. 30s. (30s. 9d.)
- 1939 Vol. I. Aerodynamics General, Performance, Airscrews, Engines. 50s. (50s. 11d.)
 Vol. II. Stability and Control, Flutter and Vibration, Instruments, Structures, Seaplanes, etc. 63s. (64s. 2d.)
- 1940 Aero and Hydrodynamics, Aerofoils, Airscrews, Engines, Flutter, Icing, Stability and Control, Structures, and a miscellaneous section. 50s. (51s.)
- 1941 Aero and Hydrodynamics, Aerofoils, Airscrews, Engines, Flutter, Stability and Control, Structures. 63s. (64s. 2d.)
- 1942 Vol. I. Aero and Hydrodynamics, Aerofoils, Airscrews, Engines. 75s. (76s. 3d.)
 Vol. II. Noise, Parachutes, Stability and Control, Structures, Vibration, Wind Tunnels. 47s. 6d. (48s. 5d.)
- 1943 Vol. I. (*In the press.*)
 Vol. II. (*In the press.*)

ANNUAL REPORTS OF THE AERONAUTICAL RESEARCH COUNCIL—

| | | | |
|---------------------------------|-------------------|---------|-------------------|
| 1933-34 | 1s. 6d. (1s. 8d.) | 1937 | 2s. (2s. 2d.) |
| 1934-35 | 1s. 6d. (1s. 8d.) | 1938 | 1s. 6d. (1s. 8d.) |
| April 1, 1935 to Dec. 31, 1936. | 4s. (4s. 4d.) | 1939-48 | 3s. (3s. 2d.) |

INDEX TO ALL REPORTS AND MEMORANDA PUBLISHED IN THE ANNUAL TECHNICAL REPORTS, AND SEPARATELY—

April, 1950 - - - - R. & M. No. 2600. 2s. 6d. (2s. 7½d.)

AUTHOR INDEX TO ALL REPORTS AND MEMORANDA OF THE AERONAUTICAL RESEARCH COUNCIL—

1909-1949 - - - - R. & M. No. 2570. 15s. (15s. 3d.)

INDEXES TO THE TECHNICAL REPORTS OF THE AERONAUTICAL RESEARCH COUNCIL—

| | | |
|-----------------------------------|-------------------|---------------------|
| December 1, 1936 — June 30, 1939. | R. & M. No. 1850. | 1s. 3d. (1s. 4½d.) |
| July 1, 1939 — June 30, 1945. | R. & M. No. 1950. | 1s. (1s. 1½d.) |
| July 1, 1945 — June 30, 1946. | R. & M. No. 2050. | 1s. (1s. 1½d.) |
| July 1, 1946 — December 31, 1946. | R. & M. No. 2150. | 1s. 3d. (1s. 4½d.) |
| January 1, 1947 — June 30, 1947. | R. & M. No. 2250. | 1s. 3d. (1s. 4½d.) |
| July, 1951 - - - - | R. & M. No. 2350. | 1s. 9d. (1s. 10½d.) |

Prices in brackets include postage.

Obtainable from

HER MAJESTY'S STATIONERY OFFICE

York House, Kingsway, London W.C.2 ; 423 Oxford Street, London W.1 (Post Orders : P.O. Box No. 569, London S.E.1) ; 13A Castle Street, Edinburgh 2 ; 39 King Street, Manchester 2 ; 2 Edmund Street, Birmingham 3 ; 1 St. Andrew's Crescent, Cardiff ; Tower Lane, Bristol 1 ; 80 Chichester Street, Belfast OR THROUGH ANY BOOKSELLER