

C.P. No. 210
(17,795)
A.R.C. Technical Report

C.P. No. 210
(17,795)
A.R.C. Technical Report



MINISTRY OF SUPPLY

AERONAUTICAL RESEARCH COUNCIL
CURRENT PAPERS

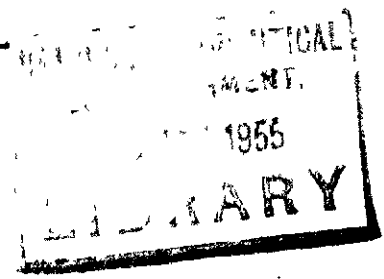

Optical Characteristics of Laminated Camera Windows

By

A. C. Marchant and B. M. Mathieson

LONDON: HER MAJESTY'S STATIONERY OFFICE

1955

Price 2s. 6d. net

U.D.C. No. 771.31 : 666.9

Technical Note No. PH.489

March, 1955

ROYAL AIRCRAFT ESTABLISHMENT

Optical Characteristics of Laminated Camera Windows

by

A.C. Marchant
and
B.M. Mathieson

SUMMARY

This Note describes optical tests on laminated camera windows of both plane and spherical form. Photographic tests of their effect upon the resolving power of an associated camera system have been carried out. The wedge angle of the windows has been measured, and the surface flatness and internal homogeneity of the plane windows tested; while the effects of the curved windows, upon the correction of the camera lens associated with them, has been assessed visually.

It is concluded that the laminating process does not, in itself, introduce deleterious effects on optical performance. Plane windows, unless optically worked to a high degree of flatness, may introduce a focal shift which will, in practice, reduce resolving power. Curved windows, even when worked to have zero power, are shown to reduce overall resolution through the introduction of astigmatism and field curvature.

LIST OF CONTENTS

		<u>Page</u>
1	Introduction	3
2	Constructional Details	3
3	Experimental Tests	4
	3.1 Flat Windows	4
	3.2 Curved Windows	4
4	Results	5
	4.1 Flat Windows	5
	4.2 Curved Windows	6
5	Discussion	6
	5.1 Flat Windows	6
	5.2 Curved Windows	8
6	Conclusions	9
7	Acknowledgement	10
	References	11

Appendices I and II

LIST OF TABLES

	<u>Table</u>
Wedge angle of Laminated Camera Windows	I
Departure from flatness	II

LIST OF ILLUSTRATIONS

	<u>Figure</u>
Construction of Flat Laminated Windows	1
" " Curved " "	2
Resolution Tests on Flat Camera Windows	3
Interferograms of Flat Window Surfaces	4
Resolution tests on Curved Camera Windows	5
" " " " " Window No.2	6
Astigmatism Measurements on Lens - Window Systems	7
" " " Lens - Window System; Curved Camera Window No.2 }	8

1 Introduction

The advent of higher air-speeds and the introduction of pressurisation have considerably increased the requirements for strength and safety of the camera windows in modern aircraft¹. While being resistant to shattering, the windows must be capable of retaining cabin pressures under all conditions. Laminated windows, comprising a sandwich of plastic material between two sheets of good quality glass, meet these mechanical requirements well; although their optical characteristics, and in particular their effects upon the performance of aircraft cameras used with them, have not been very fully studied. The characteristics of curved windows, whose use may be necessary in the interests of aerodynamic efficiency, have been studied theoretically^{2,3,4}, but a practical test of their effect upon the photographic lens associated with them, seemed desirable. One important result of the theory is to show that, to avoid a serious defocussing effect in an associated camera, the curved windows should be figured so as to have zero optical power.

In the following work three flat, and three spherical curved laminated windows made under contract 6/Inst/7636/CB.22(b) by Messrs. Triplex Ltd., have been examined for their optical properties, with the requirements of a recent specification⁵ in mind. In brief, it is specified that the windows shall be of such quality that the reduction in resolving power of an associated camera equipment shall be not greater than 10%. The wedge angle of each window is required to be less than four minutes of arc.

2 Constructional Details

2.1 The windows examined are circular, the plastic interlayer being of polyvinal butyral: viz. "Vinal".

2.2 The flat windows are designed to maintain cabin pressure, should the glass become fractured in flight. The interlayer is accordingly built up to a thickness of 0.125" from five layers of hard Vinal sheet. The total diameter of the interlayer is 12", and that of the glass components 10". The centre layer of the Vinal is cut away to a diameter of 9½", and a flat ring of 24 gauge aluminium coated aluminium alloy ("Alclad") sheet inserted. A section of such a window is shown in Fig. 1. The Alclad rim AB is clamped to the aircraft skin, so that if the glass is broken, the seal remains. The lamination is effected by means of heat and pressure in an autoclave, and the outer surfaces optically polished to be sensibly flat. The optical working has to be done after lamination, since the process has been found to deform the glass. It has not, however, proved to be necessary to work the inner surfaces to any high degree of accuracy⁶, the refractive index of the interlayer being close to that of the glass. The three windows examined had glass component thicknesses arranged as follows:-

Window A. One ¼" twin ground high quality plate glass component, and one ½" component of stirred Schlieren plate glass.

Window D. Two ¼" twin ground plate glass components.

Window I. Two ½" stirred Schlieren plate glass components.

2.3 The three curved windows have a thin Vinal interlayer (0.02") and a total thickness at the centre of approximately 0.90". 10" diameter discs of Schlieren type ream free glass, ½" thickness, were bent to approximately 19" radius in a refractory mould. After annealing, the surfaces were polished, and two such discs laminated together. The convex outer surface was finally ground and polished to a radius of curvature of 19.97" and the

concave surface to such a radius that the complete window should have zero power. A diametral section of a window is shown in Fig.2, all three windows being of approximately the same dimensions.

3 Experimental Tests

3.1 Flat Windows

(a) Photographic Resolution Test. This test followed the basic procedure described in an earlier Technical Note⁷. The image-forming system comprised a 36" f/6.3 lens, selected as being typical of those in service at the present time, mounted in front of a 210" collimator. Using the normal low contrast Cobb chart as object, a photographic run through the focus of the lens was taken at the centre, and also near the margin of its field. Each window was then placed in front of the lens, and the runs repeated.

(b) Interferometric Test. The external surfaces of the laminated windows, were examined in a Fizeau interferoscope similar to that described in an earlier Technical Note⁸.

Interference fringes in monochromatic light ($\lambda = 5461 \text{ \AA}$) were obtained in the thin air-gap between one surface of the window, and an optically flat surface. The reference flat was supported above the surface under test, and separated from it by a distance of about 0.02 mm. For a perfectly plane window, inclined with respect to the reference surface, a series of straight, parallel, and equally spaced fringes should then be obtained. Departures from flatness are revealed by distortion of the fringes and in certain cases by an alteration of their spacing.

Both surfaces of each of the three windows were examined in this way, and the fringe pattern photographed.

(c) Measurement of Wedge Angle. The wedge angle of the windows was obtained by measurement of the deviation of light rays passing through the window, and incident roughly normal to the first surface. If necessary the window was orientated so that the apex of the wedge lay perpendicular to the direction of measurement. From the value obtained for the deviation D , the angle W of the wedge could be calculated from the simple formula:

$$W = \frac{D}{(n - 1)}$$

where n is the mean refractive index of the window.

(d) Shadowgraph Test. This test has been fully described elsewhere⁸. The windows were placed in turn between a "point source" of light, and a screen. The shadow cast on the screen would then show the position of ream, bubbles, and other local discontinuities in the glass or plastic interlayer.

3.2 Curved Windows

(a) Photographic Resolution Test. The low-contrast resolution test procedure, described above for the case of the flat windows, was again employed.

test was next placed in front of the lens, with its concave surface towards and close to it; and the measurements repeated. The axes of window and lens were maintained accurately parallel and coincident throughout the test.

The procedure was repeated using the 48" f/8 lens, as a check on the results obtained. For this purpose window 2 only was employed, as having the smallest residual power. (See Section 5.2.)

(c) Star Test. The axial image formed by the test lens, of a point source of white light in the local plane of the collimator, was observed with a high-power microscope. By observing the change in the appearance of the "star image" when a window is placed in front of the lens, it is possible to estimate the extent to which the axial aberrations of the lens are modified by those of the window. Both the 36" and the 48" lenses were used in this test.

(d) Measurement of wedge angle. For the purposes of this test, the "wedge angle" for a curved window was taken to be the angle between the normals to the external surfaces, at their centres. This angle was measured using an auto-collimating telescope. A supplementary negative lens was placed in front of the telescope objective, and the position of the window under test so adjusted that the virtual focus of the divergent cone of light from the auto-collimator was coincident with the centre of curvature of the concave surface of the window. Light rays reflected by this surface were then returned along their original path, and brought to a focus in the focal plane of the telescope eyepiece. This was provided with cross-hairs, and by re-adjusting the focus of the auto-collimator so that the reflected light from the convex surface, through the thickness of the window, was next brought to a focus, it was possible to measure the angular separation of the reflected images. The window was masked so that only a small central zone was operative during the measurements, and the above procedure then ensured that these were made with respect to the normal to the centre of the concave surface. The angle A of the wedge was then calculated from the simple relation:

$$A = \frac{\alpha}{n} ,$$

where α is the measured angle, and n the mean refractive index of the window.

4 Results

4.1 Flat Windows

(a) Photographic resolution test. The results of this test are illustrated in Fig. 3, in which the logarithm of ground resolution is plotted against distance from the plane of visual focus⁷. The resultant curve, for the tangential lines in the photographic image, is shown dotted; and that for the radial lines, continuous. It will be seen that the general shape of the curves is unchanged when the windows are in position, but that with windows A and I the peaks are shifted in an outward direction, that is away from the lens, indicating that the focal length of the latter has, effectively, been increased.

In these curves, a loss of 10% in resolving power corresponds to an ordinate change of -0.046. It is clear that the maximum attainable resolving power is in all cases affected by the presence of the window to less than the specified limit.

(b) Interferometric Test. Two of the interferograms obtained are shown in Fig.4, the fringe pattern covering the central 7" diameter of each window. The slightly elliptical fringes shown in 4(a) were given by window I, and typify a mainly spherical surface with a very small cylindrical error. The same fringe shape was shown by the reverse surface of this window, and by both surfaces of window A. Pressure applied by the finger to the centre of the reference flat caused the fringes to move inwards, indicating that the test surface was concave in each case. The surfaces of window D 4(b) were more complex in shape; taking the form, roughly, of a central ridge with a depression on either side of it. The mean number of fringes intersecting a 3" radius, for windows A and I, are given in Table II.

(c) Wedge Angle. The values of the wedge angle for the three windows are shown in Table I. In no case do they exceed the specified maximum.

(d) Shadowgraph Test. The three windows proved to be remarkably free from surface defects, bubbles and vein, when examined by this method. Faint parallel striations were seen when the windows were held very obliquely in the illuminating beam, in which position internal defects of this nature are more readily shown⁸, but these would be entirely harmless in practice.

4.2 Curved Windows

(a) Photographic Resolution Test. The results of this test on the axis and at the edge of the field are shown graphically in Figs.5 and 6, for the 36" and 48" lenses respectively. As in the case of the flat windows, a drop in the peak resolving power, due to the presence of the window, is undetectable. It will be seen, however, that the position of these peaks is in general, altered when the windows are inserted, and that this shift is much greater at the edges of the field than it is on the axis of the lens. The reasons for these effects are discussed in Section 5.2.

(b) Astigmatism Measurements. The measured (perpendicular) distances of the radial and tangential foci from the plane of visual focus are plotted against field angle in Figs.7 and 8. These graphs show a marked increase in the field curvature of the lens, in each case. This is seen to be due mainly to a modification of the tangential field curvature, the radial field being influenced to a smaller extent. It is also apparent that windows 1 and 3 cause a slight focus shift of the test lens when placed in position in front of it; since the curves for "lens only" and those for "lens with window" would otherwise intersect at the 0.0 mm focus position for a field angle of zero (Fig.7).

(c) Star Test. Apart from a change of focus with windows 1 and 3, there was little change in the appearance of the star image when the windows were placed in front of the 36" lens. In the case of the 48" lens, however, there was a noticeable increase in the spherical aberration of the system. The longitudinal chromatic aberration was unaffected in all cases.

(d) Wedge angle. The values of wedge angle for the three windows are shown in Table I. The angle of window 1 (only) is slightly greater than the specified maximum.

5 Discussion

5.1 Flat Windows

The results of the interferometric tests show that windows A and I have a concave curvature on both surfaces, and should therefore behave as a weak negative lens. When such a window is placed in front of a camera lens, the focus of the latter will be shifted outward by a small amount.

The focal shift, of a camera lens of given focal length, can be calculated⁸ from the interference pattern of the window associated with it. Taking the simple case of a spherical negative curvature on both window surfaces we have:-

$$\text{Effective focal length of window} = - \frac{2 r^2}{\lambda (m_1 + m_2)} \equiv f$$

where m_1 and m_2 are the number of (circular) fringes intersecting a radius of length r , on each side of the window. λ is the wavelength of the light used in the interferometer and the refractive index of the window is 1.5, with sufficient accuracy. Now the shift of focus for a camera lens of equivalent focal length F is given, to a first approximation, by

$$\delta F = - \frac{F^2}{f} \quad (1)$$

so that:

$$\delta F = \frac{F^2 \lambda (m_1 + m_2)}{2 r^2} . \quad (2)$$

From Fig.4 it will be seen that there are about 12 roughly circular fringes over the central 3" radius zone of window I. This is approximately the area covered by the 36" lens. The reverse side of the window has about the same curvature. Hence, substituting in (2) we have, approximately:

$$\delta F = 0.035 \text{ in.} = 0.875 \text{ mm.}$$

Comparison of the curves for "lens only" and for window I, Fig.3, at 0° or 7° , will show that a shift of about this amount is, in fact obtained.

In estimating the effect which this shift will have upon the overall resolution of the lens, it is assumed that the photographic film is situated in the plane of best overall resolution, as determined by tests on the lens alone. Cameras for Service use will normally be adjusted so that this condition is obtained, and it is not in practice desirable that the setting, once made, should be altered. This plane of best photographic focus is indicated by dotted lines in Figs.3, 5 and 6. As previously mentioned, a drop of 10% in resolution corresponds, in these curves, to an ordinate change of -0.046. On this basis, it is clear from Fig.3 that, at the centre of the field, the change of resolution in the plane of best photographic focus, due to the focal shift introduced by window A, is not significant. The shift due to window I is, however, sufficiently large to cause a drop of more than 10% in resolution. The shift introduced by window D is very small, due presumably to the complex nature of its surfaces; giving in effect a combination of a positive and negative lens, which results in a small total power. The slight axial astigmatism shown is associated with the small cylindrical error in the surfaces of the windows. The effect of the focal shift is much more pronounced at the edges of the lens field, as will be seen on examination of the curves for the 7° field angle in Fig.3. Here, the drop in resolution in the plane of best photographic focus is about 30% for both windows A and I.

The fact that the maximum resolving power is unaltered when the window is inserted, indicates that any deleterious effects in a particular

focal plane are due mainly to the departures from flatness of the external surfaces of the windows, and not to the laminating process. This conclusion is supported by the homogeneity shown in the shadowgraph test.

Equation (2) above, shows that the focal shift introduced by a window is proportional to the total number of fringes associated with the two surfaces. Considering the curve in Fig. 3, for lens only at 7° field angle, it is clear that an outward shift of 0.2 mm, with respect to the plane of best photographic focus, will cause a degradation of resolving power of about 10%, the specified limit. Substituting this value for the shift in equation (2), we find that the total curvature of the surfaces must not exceed 6 fringes, or 2 fringes per inch radius, for a typical 36", f/6.3 lens. It should be noted that this figure is the algebraic sum of the curvatures of the two surfaces. Thus if one surface is convex, and the other concave, a higher curvature can be allowed on each, provided the total departure from flatness, in either the convex or concave direction, is not greater than 2 fringes per inch. The tolerance on surface curvature is increased for shorter focal length lenses of the same relative aperture, since by equation (1) the focal shift introduced by a given window is proportional to the square of the focal length of the lens. However, since it is possible that lenses of focal lengths longer than 36" may be used with these windows, it seems desirable that they should be worked at least to the degree of accuracy indicated above. These remarks are intended to apply to windows having a purely spherical surface curvature. Surface errors will normally be of this character; more complex shapes, with the very small departures from planeness under consideration, are unlikely to have more serious effects on resolution.

It was found, in the interferometer, that localised pressure on the outer rim of the thinner windows caused a noticeable distortion of the fringe pattern. The associated distortion of the windows is not thought to be a serious effect in the case of the uniform loading to be expected in pressured aircraft, since a slight and similar curvature would be added to the two surfaces. The effect should, however, be noted, since uneven strains introduced in mounting the windows might degrade the definition of a long-focus camera lens used with it.

5.2 Curved Windows

The results of the photographic resolution tests on both the 36" and 48" lenses, agree very well with those obtained from the visual tests. Both tests show a considerable increase in the field curvature of the test lens, together with a modification of the astigmatism; and in the case of windows 1 and 3, a shift of focus.

The curvature of field associated with these windows is to be anticipated from the optical properties of curved glass sheets. Some theoretical considerations are given in Appendix I. From these it is apparent that the process of figuring to zero power must inevitably introduce some field curvature, which is a consequence of the window shape only. The focal shift is consistent with a slight negative power on both windows. The factors accounting for this residual power are considered in Appendix II, and the tolerances which must be applied in manufacture, to ensure that the focus of an associated 36" lens is not shifted by more than a specified amount, are also estimated. It is clear from this that considerable manufacturing effort must be applied, if the essentially stringent requirements are to be met, and the windows are

having under-corrected fieldcurvature, would be somewhat improved. The focal shift, associated with windows possessing a slight residual power, has the same effect upon resolution as that discussed in Section 5.1. The loss of resolving power associated with the effects can be estimated from Fig.5 and 6. As before, a loss of 10% in resolving power corresponds to an ordinate change of -0.046 . Although the change in axial resolving power, in the plane of best photographic focus, is negligible; that occurring at the edges of the field greatly exceeds the specified limit, for all three windows. The loss of resolving power is least for window 2, for which the residual power, and hence the focal shift, are sensibly zero; but the change nevertheless still exceeds the limiting value, with either the 36" or the 48" lens in use. As shown by the star test, the spherical aberration introduced by the windows is completely overshadowed by that of the 36" lens, and its effect is only apparent in this test, when a highly corrected lens, such as the 48" f/8 lens considered here, is used in conjunction with it. The curve for axial resolving power, with window 2 (Fig.6), shows however that the effect is in practice, entirely negligible, the maximum resolution being unaltered.

It is evident from the above results that the overall resolving power of an aircraft camera will, in general, be degraded when it is used in conjunction with a curved window, even when this has been optically worked to have zero power. There is no evidence that this is a result of the laminating process, and the effect can therefore be taken to be a function of the window shape only. The loss of definition of the long-focus lenses under consideration, would be more serious, the shorter the mean radius of the window surfaces (Appendix I).

In general, it appears that the best means of ensuring satisfactory performance with a curved camera window, is to consider it as an integral part of the complete optical system when a new lens is being designed. In this way the aberrations introduced by the window can be compensated in the lens components which follow it. However, this would mean that different camera lenses could not necessarily be used with a given window. It seems possible that a compromise solution might be found in the use of auxiliary lenses of zero power, and whose radii are adjusted so that the field curvature introduced by the window could be annulled. It is not, however, clear to what extent the manufacturing and installation difficulties would be increased by such a relatively complex system; and the way in which the aberration characteristics (apart from field curvature) of the associated camera lens would be modified would require separate investigation.

6 Conclusions

6.1 The experimental work described has shown that the windows examined will reduce the resolving power of a long-focus camera lens associated with them. This reduction, in general, exceeds the specified limit of 10%. There is no evidence however, that the effect is due to the laminated structure of the windows.

6.2 In the case of the "flat" windows, the degradation of definition is due mainly to a focal shift of the camera lens, which is a consequence of a slight curvature on the external surfaces of the windows.

It appears that for lenses of focal lengths greater than about 24", the windows should be optically worked so that the algebraic sum of the departures from flatness on the two surfaces does not exceed 6 circular fringes over a 6" diameter. The required accuracy of working is, however, reduced the shorter the focal length of the lens to be used with the window.

The deformation of the thinner windows, due to pressure on the projecting inter-layer, while not considered to be a serious effect, should be borne in mind when fitting the windows to aircraft.

6.3 The curved windows, even when worked so as to have zero power, introduce positive field curvature, and the effect on an associated camera lens will depend on its state of correction. The overall resolution is likely to be improved, when the window is employed with a lens possessing negative field curvature, but reduced when lenses with flat fields or with positive field curvature, are in use. The astigmatic correction of the camera lens is also effected, although to a somewhat smaller extent.

In general, therefore, it appears necessary to design and manufacture the lens and window together, as a single optical system. This would, of course, mean that cameras would no longer be completely interchangeable, an important disadvantage in Service use.

It is shown in Appendices I and II of this note, that the residual power and the curvature of field associated with a spherical window, are both increased as the radius of curvature of the window is reduced. Windows designed for situations in which the radii of curvature are necessarily, from an aerodynamic standpoint, rather small, are therefore likely to reduce the resolution of an associated camera to a considerable extent. It is probable that only lenses of very short focal lengths (such as the lenses for ciné cameras) could be satisfactorily used in these circumstances; unless, as mentioned before, the window has been designed for use with a particular lens. In addition to the characteristic curvature of field, the expense incurred in the bending process and in the subsequent optical working, and the considerable effort required to achieve sensibly zero power, make the use of curved camera windows, in their present form, somewhat undesirable.

It seems possible that a solution to the problem of retaining interchangeability of equipment, and of avoiding an associated loss of image quality, might lie in the use of auxiliary correcting lenses to flatten the field of the curved windows, without introducing any power. However, such a system would necessarily be somewhat complex, and its optical characteristics would have to be carefully studied. It does not seem that such an investigation is justified at the present time, in view of the number of disadvantages which the curved windows have over the flat type, and of their added expense, and it appears desirable that, unless aerodynamic considerations make it impossible, the use of curved windows, with long-focus aircraft camera lenses, should be avoided.

6.4 It is satisfactory to note however that, notwithstanding the inherent difficulties of field curvature and astigmatism, laminated camera windows of spherical form can be manufactured to within prescribed tolerances for homogeneity and shape.

7 Acknowledgement

Thanks are due to Dr. Holland, of Messrs. Triplex Ltd., for his helpful co-operation during the course of this development contract.

REFERENCES

<u>No.</u>	<u>Author</u>	<u>Title, etc.</u>
1	R.W. Fish	"Camera Windows for Aircraft." RAE Technical Memorandum No. PH.63.
2	G.S. Speak and R.J. Pitt	"The effect of Concentric Spherical Glass Shells on the Performance of Camera Lenses." RAE Technical Memorandum No. PH.26.
3	R.W. Fish and H. Barnes	"Curved Windows for use with Ciné Gun Cameras in Aircraft." RAE Technical Memorandum No. PH.124.
4	R.J. Pitt and B.M. Mathieson	"The use of Curved Camera Windows in Aerial Photography." RAE Technical Note No. PH.438.
5		"Windows, Flat or Spherical, Laminated Glass." RAE Specification No. RPH.356.
6	R.W. Fish and G.M. Whittle	"Laminated Camera Windows: Notes on their manufacture and test." RAE Technical Note No. PH.437.
7	R.W. Fish	"Photographic Lens Testing" RAE Technical Note No. PH.443.
8	RAE Optics Section	"The Selection of Glass for Aircraft Camera Windows." RAE Technical Note No. PH.427.
9	L.C. Martin	"Technical Optics." Vol.1,(Pitman 1948), p.137.
10	L.C. Martin	Ibid. p.133.

APPENDIX I

The Petzval field curvature ($\frac{1}{R}$) associated with a glass plate of refractive index n , bounded by spherical surfaces of radii r_1 and r_2 , is given by⁹:-

$$\frac{1}{R} = \frac{n-1}{n} \left(\frac{1}{r_2} - \frac{1}{r_1} \right) \quad (A)$$

This curvature is independent of the thickness of the plate, or of the distance of the object field.

It is evident that the image field would be plane ($R = \infty$) if $r_1 = r_2$, as in the case of a window having external surfaces of equal radii.

However, as shown in Appendix II, in order that the window shall have zero power, r_2 must be made slightly less than r_1 . Since r_1 and r_2 have the same sign, this means that ($\frac{1}{R}$) will have a finite, positive, value.

Petzval field curvatures are additive, so that the effect of such a window is to add a positive quantity to the field curvature of a lens in front of which it is placed. That is to say, the final image surface is made more nearly convex towards the lens, a result which is borne out by the experimental result.

In practice the amount by which the lens field curvature is modified will be influenced by the astigmatism also introduced by the window. However, it can be shown that, for a simple optical system such as that under consideration, the tangential and radial field curvatures will be larger than the Petzval curvature, and of the same sign. In particular, the tangential field, at a given distance from the optical axis of the system, will be displaced from the Petzval surface by an amount three times the corresponding displacement for the radial field. This shows, qualitatively at least, why the tangential field of a photographic lens should be modified to a much greater extent than the radial field - the results described in Section 4.2(b) of the present note. Equation (C) (Appendix II) shows that, for a given value of thickness and refractive index, the difference in radii, required to give a window zero power, is a constant. It is thus clear from the above equation (A) that decreasing r_1 and r_2 will increase the curvature of field $\frac{1}{R}$. The degradation of the overall resolution of a given camera lens will thus be greater, the more steeply curved the window associated with it.

APPENDIX II

It can be shown that the focal length f of a simple lens of thickness t is given by

$$\frac{1}{f} = \frac{(n-1)}{r_1 r_2} \left(r_2 - r_1 + \frac{t(n-1)}{n} \right) \quad (B)$$

where r_1 , r_2 and n have the same significance as in Appendix I.

For zero power ($1/f = 0$) the values of r_1 and r_2 must be arranged so that:

$$r_2 = r_1 - \frac{t(n-1)}{n} . \quad (C)$$

In other words, if r_1 and r_2 are both positive, r_2 must be less than r_1 . Evidently, the question of whether or not the completed window has zero power, depends on the extent to which the values of r_1 , r_2 , t and n satisfy equation (C).

It is of interest, therefore to differentiate equation (B) with respect to these different variables, to see to what extent the power ($1/f$) is affected.

Differentiating with respect to r_2 , we have:-

$$\frac{\partial \left(\frac{1}{f} \right)}{\partial r_2} = \frac{n-1}{r_2^2} \left(1 - \frac{t(n-1)}{n r_1} \right) .$$

Inserting the approximate values: $r_1 = r_2 = 20''$, $t = 0.9''$, $n = 1.5$ we obtain (in appropriate units):-

$$\frac{\partial \left(\frac{1}{f} \right)}{\partial r_2} = \frac{\partial r_2}{812} . \quad (D)$$

We may assume that the power $1/f$ of the window was initially zero before the change of radius ∂r_2 . In this case the actual power of the window will be given by the expression (D).

Equation (1), in an earlier part of this Note, gives for the focal shift of a camera lens used with the window:

$$\delta F = - \frac{F^2}{f} .$$

Whence from (D):

$$\delta F = -F^2 \cdot \frac{\partial r_2}{812}.$$

For a 36" lens, and a maximum permissible shift of 0.2 mm, this gives:-

$$\underline{\frac{\partial r_2}{812} = 0.005''}.$$

Differentiating (B) now with respect to n , we have:-

$$\frac{\partial \left(\frac{1}{f} \right)}{\partial n} = \frac{r_2 - r_1}{r_1 r_2} + \frac{t(n^2 - 1)}{n^2 r_1 r_2}.$$

Inserting the values $r_1 = 19.97''$, $r_2 = 19.66''$, $n = 1.52$, $t = 0.9''$:
which are appropriate to a window with zero power (exact values are necessary here since both terms are small) we obtain:-

$$\partial \left(\frac{1}{f} \right) = \frac{\partial n}{1963}.$$

Hence, we have, for the maximum tolerance on n , for a 36" lens, and a focal shift of 0.2 mm:-

$$\underline{\partial n = 0.012}.$$

Finally, differentiating (B) with respect to t :

$$\frac{\partial \left(\frac{1}{f} \right)}{\partial t} = \frac{(n-1)^2}{n r_1 r_2}.$$

Hence,

$$\partial \left(\frac{1}{f} \right) = \frac{\partial t}{2400},$$

when $n = 1.5$, $r_1 = r_2 = 20''$ and for a maximum focal shift of 0.2 mm with

Although the limit on thickness and refractive index could be easily achieved, it will be seen that the tolerance on radius is very small, and extreme care in manufacture would be needed to guarantee the radii to the limits stated. In the last stage, therefore, the windows are best figured to have zero power by observation. It is doubtful, however, whether the normal methods of doing this would approach the sensitivity of an actual measurement, with a microscope, of the change in focus of a camera lens of long focal length.

It will be noticed, in the equation for $\partial(1/f)/\partial r_2$, that the power of the window, for a given ∂r_2 , will be greater, the smaller the value of r_2 . The tolerance on radius is therefore even smaller for steeply curved windows, and the manufacturing difficulties correspondingly increased.

TABLE I

Wedge angle of Laminated Camera Windows

Window		Wedge angle (Minutes of Arc)
Type	No.	
Flat	A	2
	D	4
	I	0.5
Curved	1	5
	2	4
	3	2

TABLE II

Departure from flatness

Window	Number of fringes per 3" radius All surfaces concave	
	Marked Side	Reverse Side
A	3	11
I	12	12

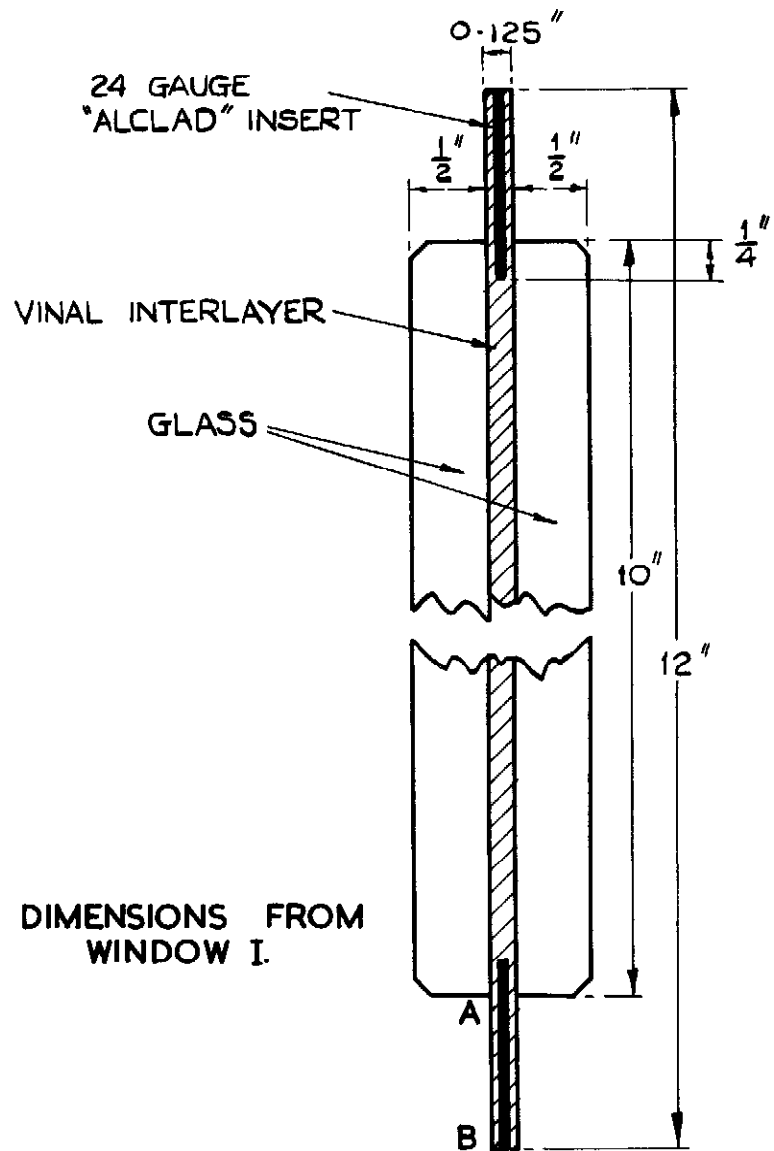

FIG. 1. CONSTRUCTION OF FLAT LAMINATED WINDOWS.

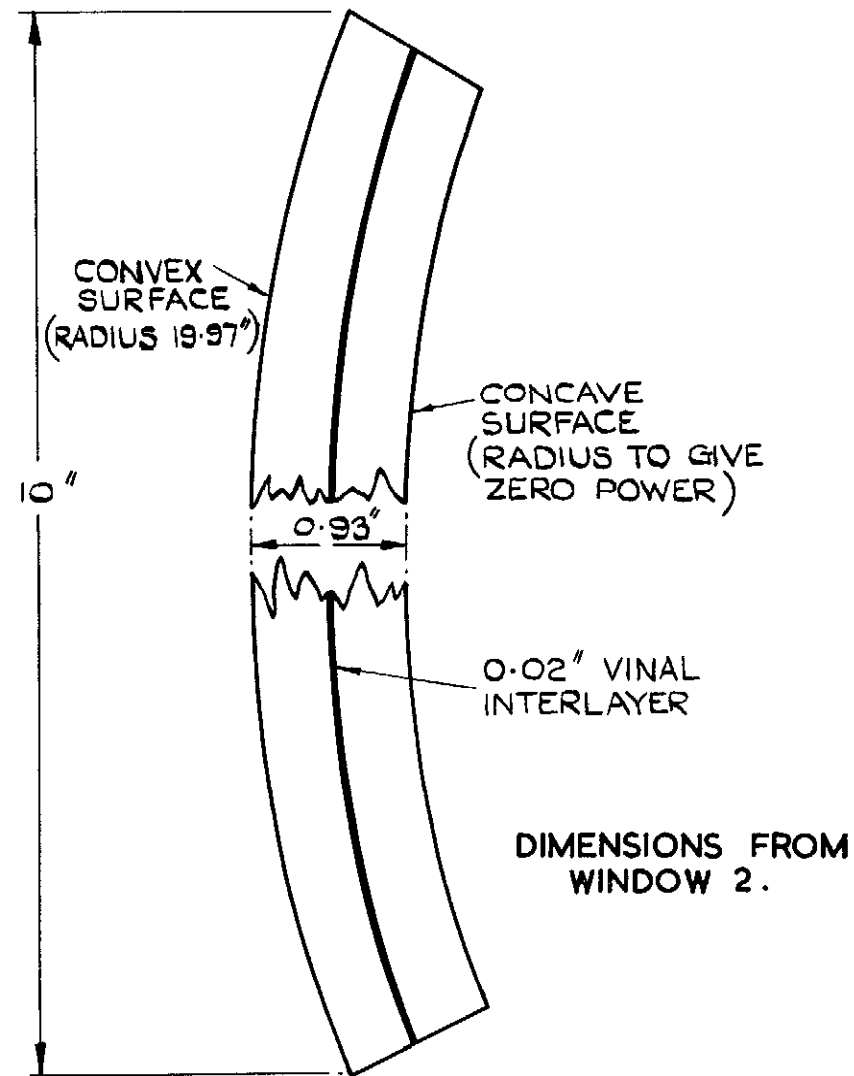

FIG. 2. CONSTRUCTION OF CURVED LAMINATED WINDOWS.

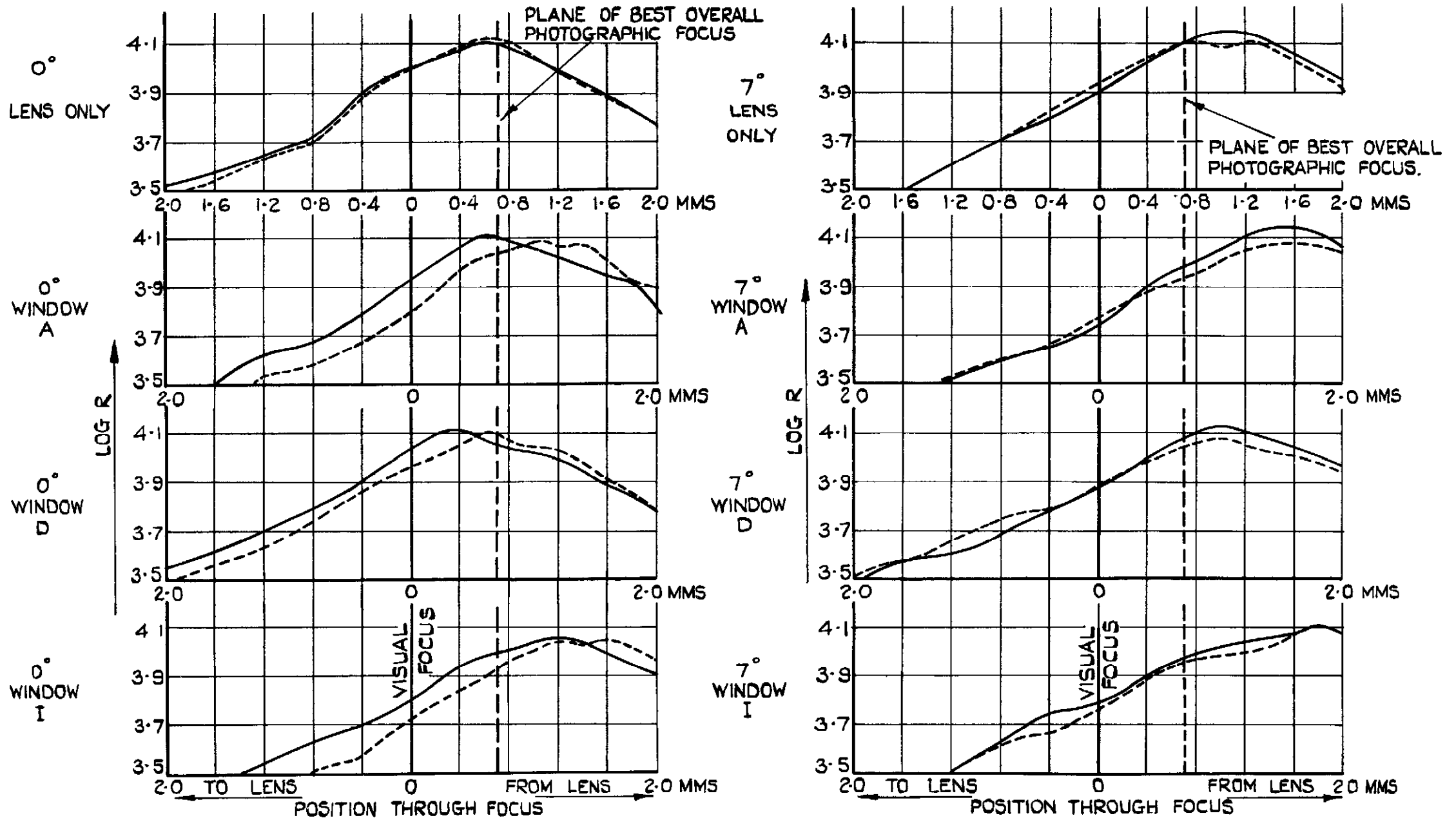
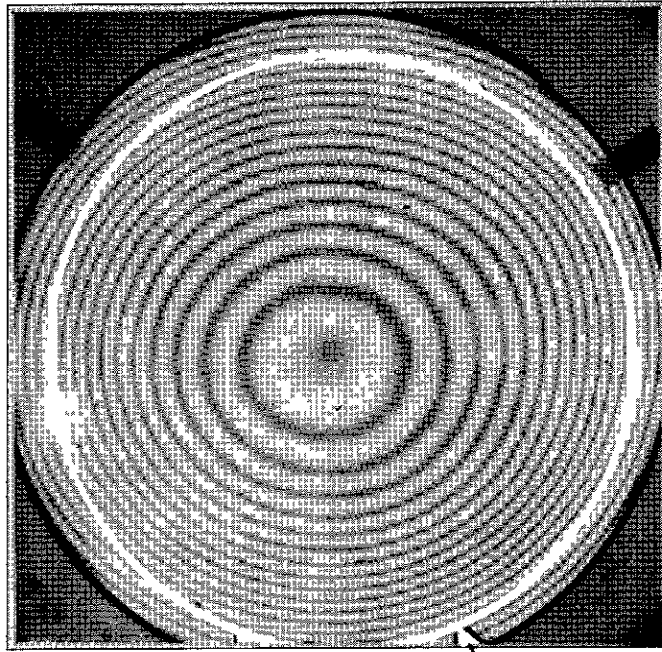
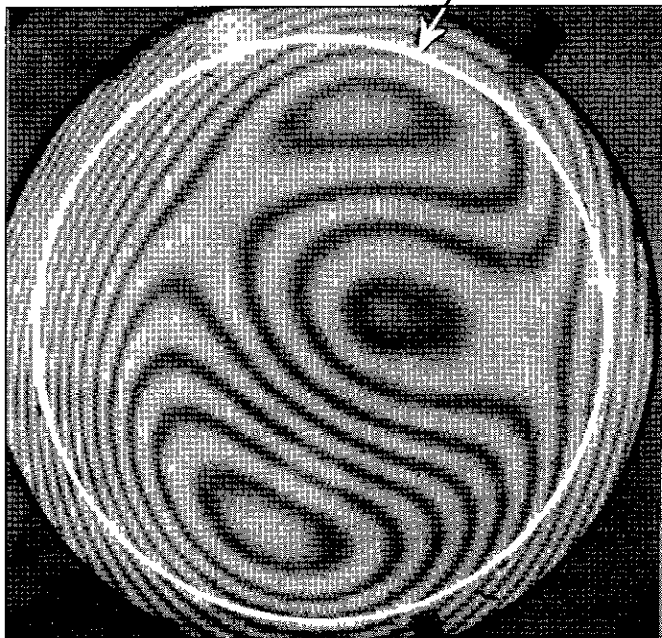

FIG. 3. RESOLUTION TESTS ON FLAT CAMERA WINDOWS.
 (USED WITH WRAY 36 IN. f/6.3 TELEPHOTO LENS No. 110127 AT f/6.3)



a. WINDOW I

6" diameter



b. WINDOW D

FIG 4a & b. INTERFEROGRAMS OF FLAT WINDOW SURFACES

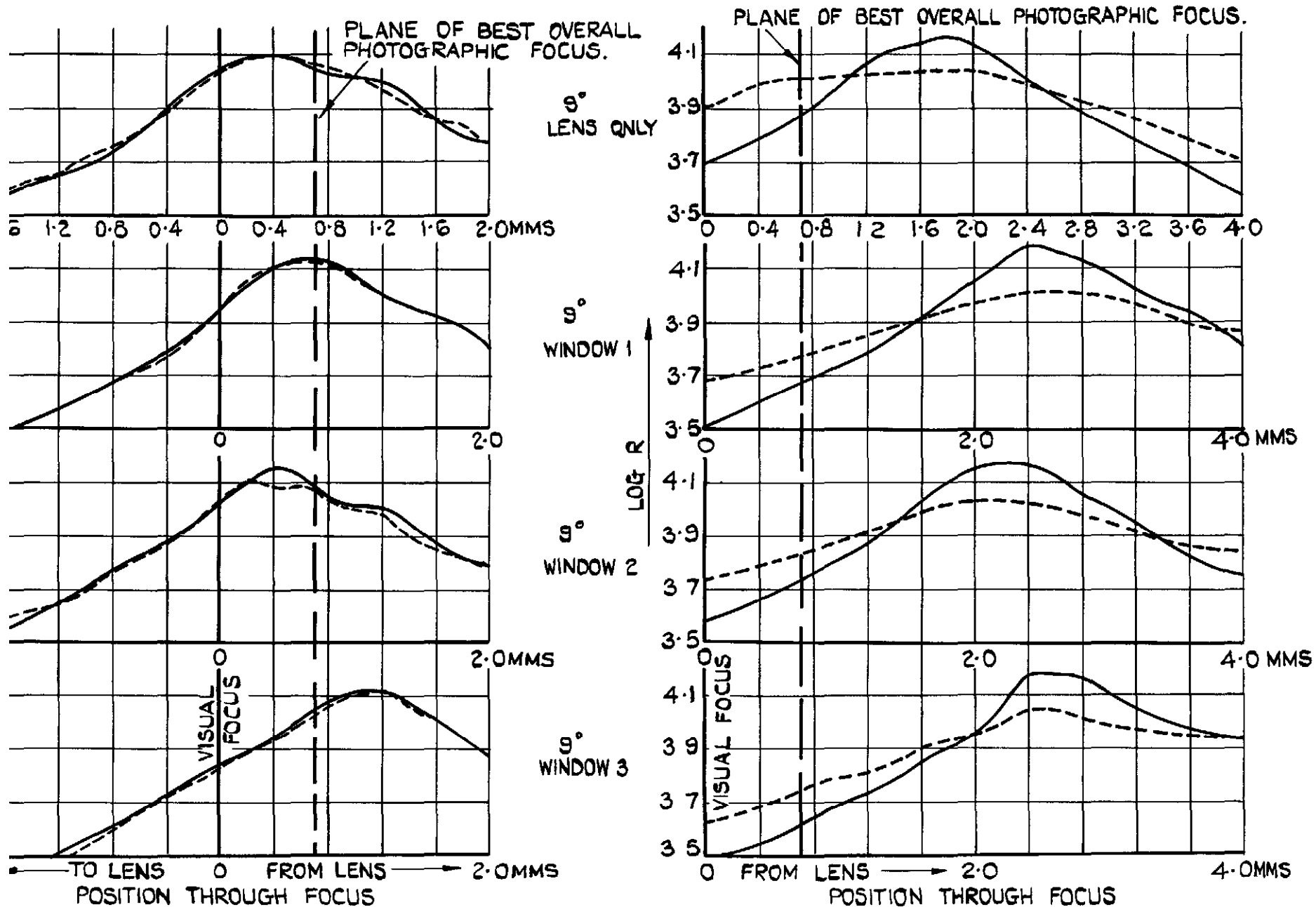

5. RESOLUTION TESTS ON CURVED CAMERA WINDOWS.
 (USED WITH WRAY 36 IN. f/6.3 TELEPHOTO LENS NO 110127 AT f/6.3.)

FIG. 6.

RESOLUTION TESTS ON CURVED CAMERA WINDOW NO 2.
(USED WITH WRAY 48. IN. 1/8 TELEPHOTO NO 11818. AT 1/8.)

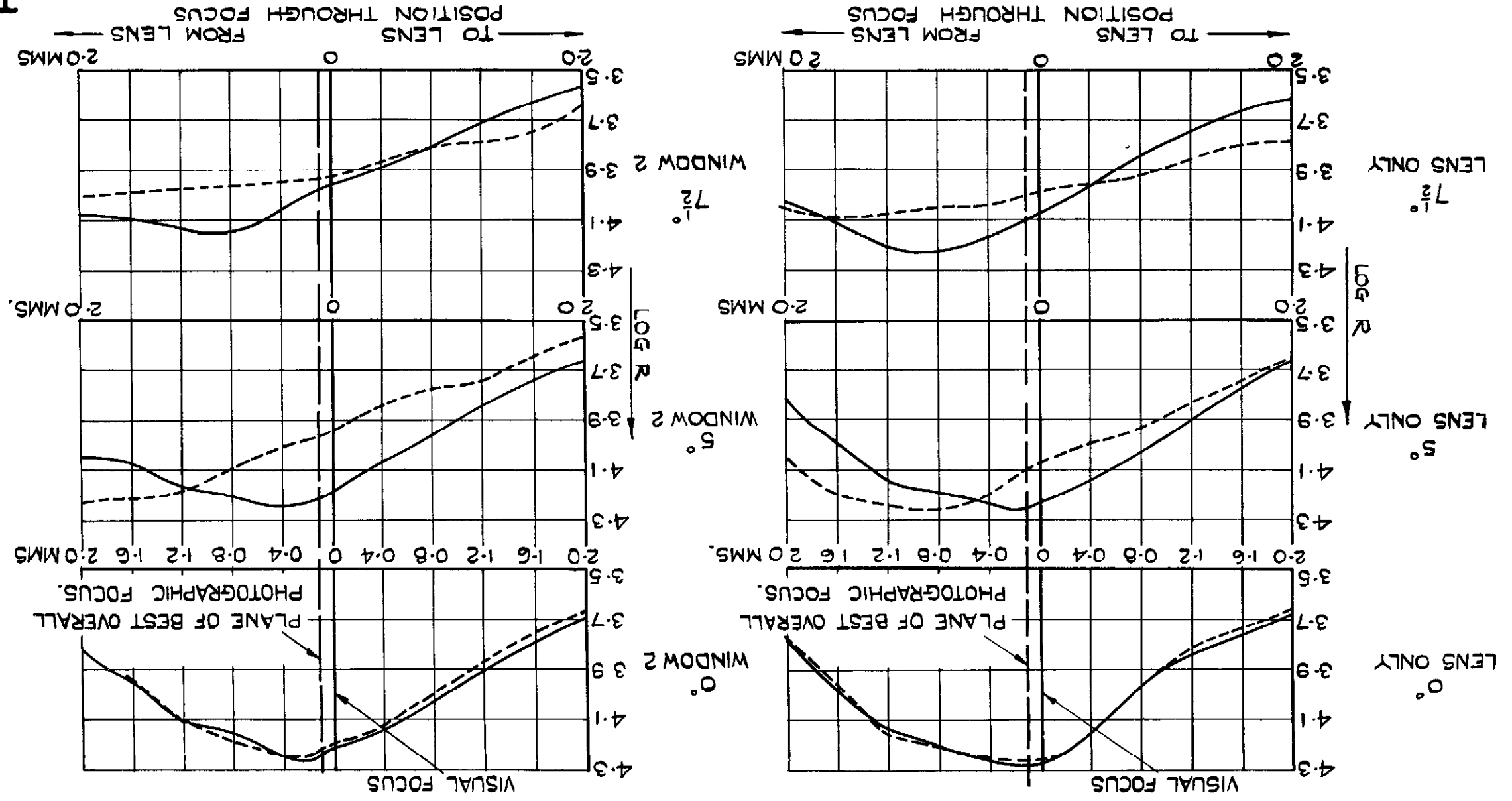

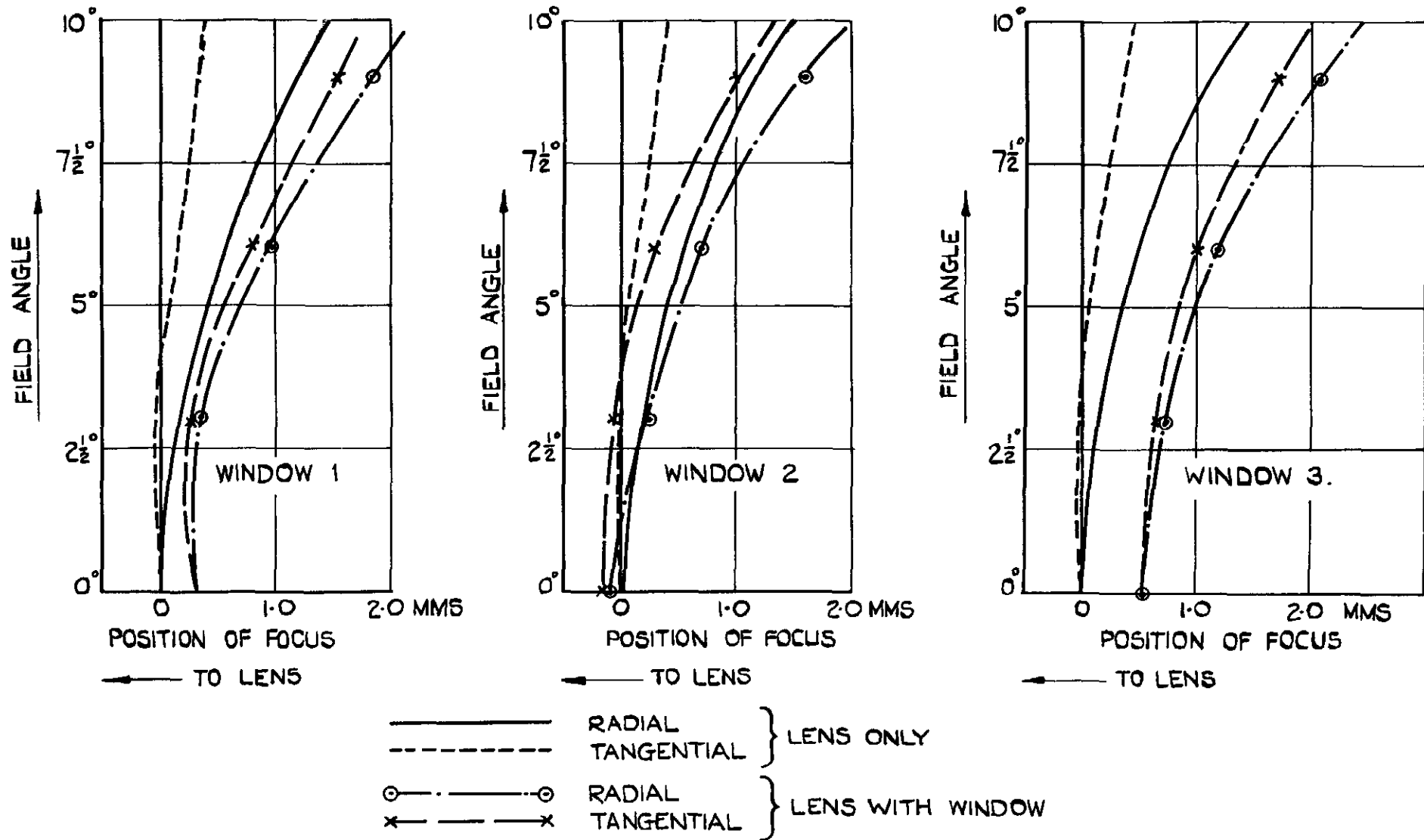

FIG. 7. ASTIGMATISM MEASUREMENTS ON LENS - WINDOW SYSTEMS.

CURVED CAMERA WINDOWS USED WITH WRAY 36 IN. f/6.3 TELEPHOTO LENS N° 110127.

FIG. 8.

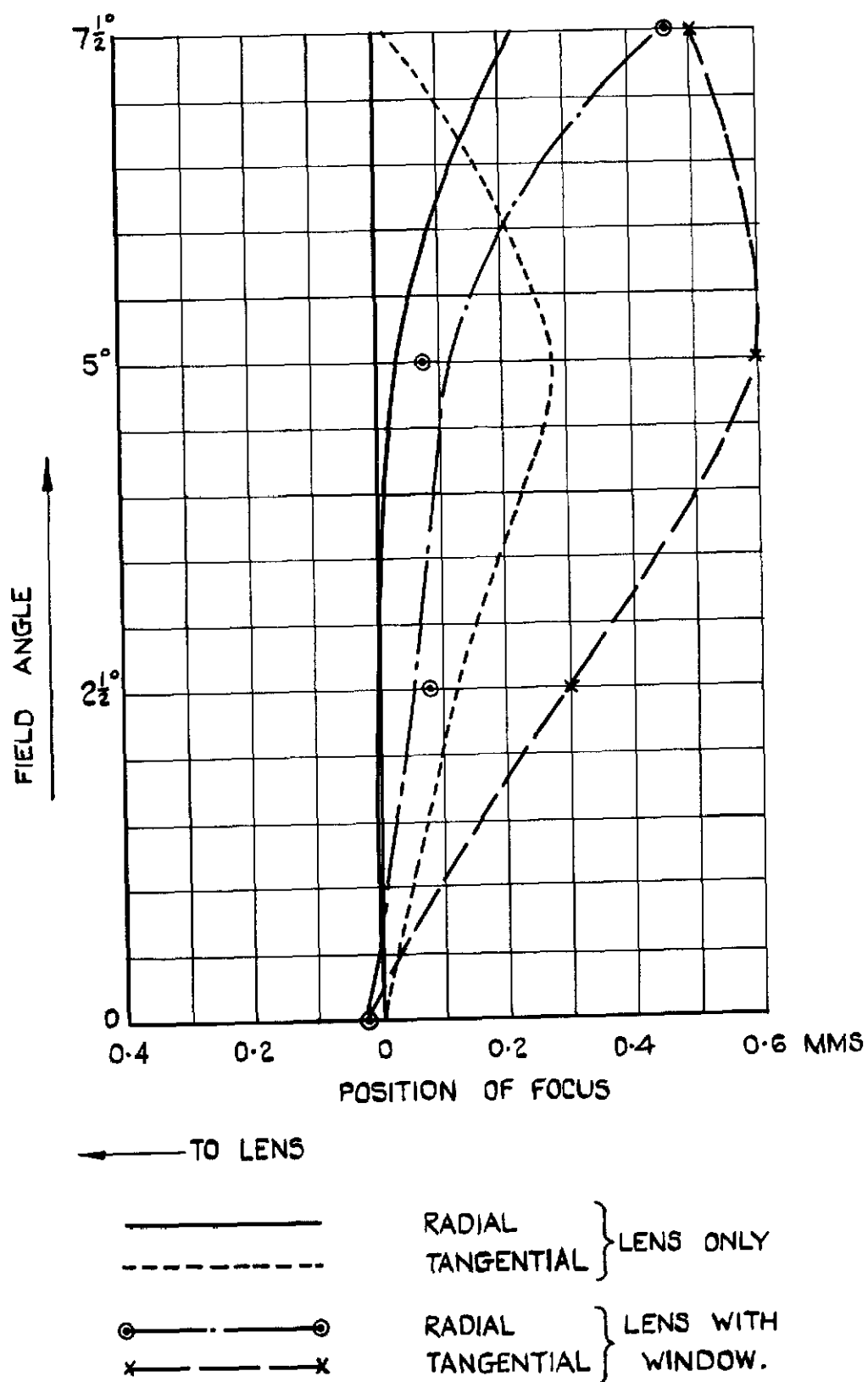

FIG. 8. ASTIGMATISM MEASUREMENTS ON LENS - WINDOW SYSTEM.

CURVED CAMERA WINDOW No. 2;

WRAY 48 IN. f/8 TELEPHOTO No. 118B18.

Crown Copyright Reserved

PUBLISHED BY HER MAJESTY'S STATIONERY OFFICE

To be purchased from

York House, Kingsway, LONDON, W.C. 2; 423 Oxford Street, LONDON, W.1
P.O. Box 569, LONDON, S.E. 1

13a Castle Street, EDINBURGH, 2	1 St. Andrew's Crescent, CARDIFF
39 King Street, MANCHESTER, 2	Tower Lane, BRISTOL, 1
2 Edmund Street, BIRMINGHAM, 3	80 Chichester Street, BELFAST

or from any Bookseller

1955

Price 2s. 6d. net

PRINTED IN GREAT BRITAIN