

C.P. No. 1166



ROYAL AIR FORCE ESTABLISHMENT
BEDFORD.

C.P. No. 1166

MINISTRY OF AVIATION SUPPLY

AERONAUTICAL RESEARCH COUNCIL

CURRENT PAPERS

Some Full-Scale Measurements
of the Flow in the Wake
of a Hangar

by

M. J. Colmer

Engineering Services R.A.E., Bedford

LONDON: HER MAJESTY'S STATIONERY OFFICE

1971

PRICE 40p NET

C.P. No.1166*
November 1970

SOME FULL-SCALE MEASUREMENTS OF THE FLOW IN THE WAKE OF A HANGAR

by

M. J. Colmer

Aerodynamics Dept., RAE, Bedford

SUMMARY

An experiment to measure the flow behind a full-scale building at RAE Bedford is described. The results of one set of data show that the whole wake was slowly oscillating and that the turbulence intensity in the wake was greater than upstream. An hypothesis for the wake motion is put forward and the effect of the wake behind a building on conventional and V/STOL aircraft is considered.

* Replaces RAE Technical Report 70202 - ARC 32863.

CONTENTS

	<u>Page</u>
1 INTRODUCTION	3
2 THE TEST SITE AND INSTRUMENTATION	4
3 MEASUREMENTS ON 3 JUNE 1969	5
3.1 Meteorological conditions	5
3.2 Analysis	5
3.3 Results	7
4 DISCUSSION	9
4.1 Velocity and turbulence intensity profiles	9
4.2 Power spectra and autocorrelation functions	9
4.3 An hypothesis for the wake motion	10
5 IMPLICATIONS OF THE RESULTS	12
6 CONCLUSIONS	13
Table 1	14
References	15
Illustrations	Figures 1-13
Detachable abstract cards	-

1 INTRODUCTION

The way in which obstacles on the ground, such as buildings or woods, affect the structure of atmospheric turbulence may be of importance when considering the take-off and landing of conventional and V/STOL aircraft on runways or landing pads close to such obstacles¹. The wake behind these obstacles may also have an important effect on the structural loading of buildings in the wake and on the dispersion of pollutants. Wind tunnel tests have indicated that the wake behind these obstacles will have a higher turbulence intensity than the upstream flow and that spatial gradients of windspeed may exist in the downstream flow which do not exist in the undisturbed flow. Thus, a conventional aircraft taking off or landing across such a wake would suddenly encounter turbulence of a different character from that outside the wake. VTOL aircraft, taking off or landing in restricted sites - particularly urban areas - may be affected by turbulent wakes from tall buildings for a considerable portion of the descent or take-off and climb-out.

The experiment at RAE Bedford has been designed to investigate, in full scale, the wake of an isolated hangar in order to evaluate the structure and magnitude of the effects mentioned above. Measurements of the three components of turbulence have been made by means of anemometers and bi-directional wind-vanes mounted on towers which are situated both upstream and downstream of a hangar. In conjunction with this full scale experiment, wind tunnel tests on the flow round a model of the hangar and its environment have been planned in order to make a detailed comparison of full scale and model measurements.

The results presented here consist mainly of the anemometer measurements of a single 40 minute run. More analysis of data from the wake of the hangar, recorded on several separate occasions and including all three components of turbulent velocity, will have to be made before any general conclusions can be drawn. Since experiments in the atmosphere are not exactly repeatable, and because the wind blows in just the right direction for the experiment only occasionally, the results of single measurements will be presented separately at first with more general conclusions and statistics following later. However, these first results do give an indication of the extent of the wake, the intensity of turbulence in the wake and the spatial gradients in the flow behind the hangar.

2 THE TEST SITE AND INSTRUMENTATION

The experiment was performed on the Tunnel Site at RAE Bedford, situated on a small plateau 40 m above the Ouse Valley, as shown in Fig.1. The ground is fairly flat for about 800 m all round the hangar and the main complex of buildings is far enough away from the hangar (200 m) not to disturb the upstream flow. Instrumented masts stand on a line perpendicular to the long side of the isolated hangar, approximately in the direction NW-SE. The hangar is 30 m long, 15 m wide and 10 m high, and has a roof pitch of 10° . Upstream from the hangar, NW, the only obstacles on the ground are short hedges, 1 to 2 m high, and a few isolated trees at least 400 m away. A diagram of the layout of the site is shown in Fig.2a and a general view of the site is shown in Fig.2b. The nomenclature used to identify each mast is that A is the upstream mast; P, Q and R are the downstream masts, being 5, 14 and 23 hangar heights downstream respectively; and Z is the downstream mast which is laterally displaced from the centreline. A number following this mast identification letter indicates the height above ground (in metres) at which the measurement was made.

Masts of triangular cross-section and an open lattice structure were used for the instrumentation; the faces of the masts are 0.3 m wide and the masts are guyed at several points. Two masts, the upstream and furthest downstream masts, are 30 m high and the other three are 15 m high. Instrument platforms with cable terminals are positioned at 3 m intervals up the masts with a gap between 18 m and the top of the 30 m masts. All cabling returns to a central console which is used to select which transducer signals are to be recorded. Twelve sets of instruments are available and these can easily be placed at any combination of the 27 instrument platforms, thus enabling the configuration of instrumentation to be quickly changed if the conditions require it. The position of the instruments on 3 June 1969 is indicated in Table 1.

Both the anemometers and the bidirectional windvanes were tested in a wind tunnel to determine their dynamic response to step inputs². The light-weight cup anemometers (Cassella T16108/1) have a fairly short distance constant of 5.5 m due to the virtually frictionless photoelectric transducer. The distance constant of an anemometer is the time taken to reach $\left(1 - \frac{1}{e}\right)$ of a step change in velocity multiplied by the final velocity. The bidirectional vanes - made by Ancillary Developments to an AWRE design - have a distance constant of 4.3 m and a damping coefficient, relative to critical damping, of 0.45 at 10 m/s. The vanes behave like linear second order systems and the distance constant is defined as the wind velocity divided by the undamped

natural frequency at that velocity. Toroidal potentiometers with a resolution of 0.0023 radians are used to measure the vane angles in the vertical and horizontal planes. A photograph of these instruments mounted on a platform is shown in Fig.3. These instruments were chosen so that they would be robust and need little maintenance, but at the same time cover the frequency range of interest for calculations of aircraft response to low altitude turbulence; i.e. 10^{-2} Hz - 1 Hz.

Radio telemetry was used to transmit the signals chosen on the central console to the Telemetry Laboratory in Aero Flight building. Here the signals were recorded on analogue magnetic tape for subsequent analysis. A few of the signals could also be selected for recording on photographic paper on site.

3 MEASUREMENTS ON 3 JUNE 1969

3.1 Meteorological conditions

The morning of 3 June 1969 was generally cloudy with shower clouds developing during the period of measurements, 1030-1130 BST. A moderate to fresh breeze was blowing from the NW throughout the morning and the temperature fell steadily. The mean windspeed and mean wind direction at 10 m, for the period of measurement, were 9 m/s and 330° respectively. This mean direction is about 10° off the line of the masts, but since the direction varied by $\pm 20^{\circ}$ this was not thought to be too serious an offset. There was a rain shower which lasted from 1050 BST to the end of the period of measurement.

3.2 Analysis

The telemetry and tape recorder were turned on at 1030 BST after an instrumentation check. Anemometers were in operation at the following positions: at the 3 m, 9 m, 18 m and 30 m levels on mast A; at the 3 m, 9 m and 15 m levels on mast P; at the 9 m level on mast Q; at the 30 m level on mast R; and at the 9 m and 15 m levels on mast Z. In addition, bidirectional vanes were in operation at the 3 m levels on mast A and mast P.

The analogue signals had to be converted to digital through a sampling process. Power in a signal at frequencies higher than half the sampling frequency will produce an error in the estimated power at all frequencies due to the fact that sampling a sine wave at a frequency lower than that of the sine wave produces a sine wave with another, still lower, frequency³ - this effect is called 'aliasing'. In order to reduce the effect of aliasing as much as possible, the analogue signals were passed through a second order low

pass filter with a cut-off frequency of 0.25 Hz. The filtered signal was then played back through a Mullard analogue to digital converter with a sampling frequency of 1 sample/s, and the digital data was recorded on magnetic tapes.

These digital tapes were then used as input for analysis programs on the ICL 1907 computer. The computer was used to calculate the mean windspeed and rms of the fluctuations of each anemometer signal. Power spectra and auto-correlation functions were also computed, using the Blackman-Tukey method (see Ref.3 for the details of this method).

Cup anemometers measure the absolute value of horizontal windspeed, i.e. the magnitude of the vector \underline{u} in Fig.4.

mean wind direction

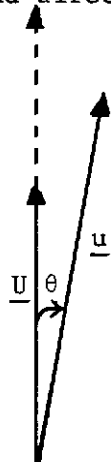

\underline{U} is the mean wind vector

\underline{u} is the instantaneous wind vector

The anemometer measures $|\underline{u}|$, whereas the longitudinal component of wind is $|\underline{u}| \cos \theta$.

Fig.4 Interpretation of anemometer measurements

If the mean wind vector is \underline{U} , then the fluctuation from the mean as measured by the anemometer is $|\underline{u}| - |\underline{U}|$. On the other hand, the fluctuation from the mean in the direction of the mean wind vector is $|\underline{u}| \cos \theta - |\underline{U}|$, where the angle between \underline{u} and \underline{U} is θ . Hence, if θ is less than about 20° , as it is in the upstream flow, the anemometer can be considered to measure the longitudinal component of the wind. Where bidirectional vanes were in operation the longitudinal, lateral and vertical components of the wind were resolved from the anemometer reading and the deflection of the wind vane.

3.3 Results

A useful parameter of the flow to use for comparison of mean windspeeds and rms fluctuations is the mean windspeed at the top of the boundary layer, U_0 . The value of U_0 was obtained by extrapolating the upstream wind profile from 30 m to the top of the boundary layer, 600 m, using the theoretical power law

$$\frac{v_z}{v_{10}} = \left(\frac{z}{10}\right)^\alpha$$

as shown in Fig.5a (z is the height above ground in metres). The mean values and rms fluctuations for the anemometer signals from all the recording positions are shown in Table 1 as a fraction of U_0 . The upstream velocity profile follows the above power law with the parameter α equal to 0.18 and the upstream turbulence intensity (the rms divided by U_0) is about 0.09, in agreement with other data for open countryside⁴.

Fig.5b shows the power spectra for the upstream flow. For frequencies greater than 0.1 Hz the upstream spectra are proportional to $f^{-5/3}$, where f is the frequency. At frequencies between 0.1 Hz and 0.002 Hz the power spectra are proportional to f^{-B} , where the parameter B follows a pattern for horizontal windspeed spectra near the ground which agrees with other data⁵, increasing from a value of 1.09 at 3 m above ground to 1.29 at 30 m above ground. The upstream autocorrelation functions, shown in Fig.10, also follow the usual pattern for atmospheric boundary layer flow, having a fairly smooth exponential decay.

A part of the time history of all three components of turbulence for the flow at the 3 m level on mast A is shown in Fig.6. We note that the lateral record has a dominant low frequency component of about 10^{-2} Hz, which is virtually absent from the measured longitudinal and vertical components of the windspeed. This low frequency component in the lateral motion is probably due to some fairly large scale influence on the upstream flow, such as the rising ground between the river valley and the plateau. As was explained earlier, the anemometer measures the longitudinal motion and therefore this regular fluctuation in the lateral component does not show up in the power spectrum of the anemometer signal.

As can be seen from Fig.7, the wind at mast P, about 5 hangar heights downstream from the hangar, is very much influenced by the hangar. At 3 m and 9 m above ground the mean windspeed is reduced by about 15% from the upstream

value - due to the sheltering effect of the hangar - whereas at 15 m above ground the mean windspeed is slightly greater than the upstream value - due to the acceleration of the flow over the top of the hangar. The downstream turbulence intensity (the rms divided by U_0), however, is greater than upstream at all levels; the increase being 27% at 3 m, 14% at 9 m and 15% at 15 m above ground. If the local turbulence intensity (the rms divided by the local mean windspeed) is considered, the increase over the upstream values is even greater, (rising to 45% at 3 m above ground), due to the decrease in mean windspeed behind the building.

On mast Q, 14 hangar heights downstream, the only measurement was at the 9 m level. It appears that at this level the effect of the hangar is largely decayed since the mean windspeed is now only 3% less than upstream and the turbulence intensity is 3% greater than the upstream value. The flow at mast Z, which is 5 hangar heights downstream and 1.7 hangar widths off the centreline, (see Fig.2), differs from the flow at the upstream mast to an even lesser extent than that at mast Q. However, at 30 m on mast R, 23 hangar heights downstream, both the mean windspeed and the turbulence intensity are greater than upstream, by 9% and 18% respectively.

The power spectra for mast P are shown in Fig.8. Two features stand out: (a) a peak in each spectrum, the peak being largest 3 m and smallest 15 m above ground; (b) the spectra are proportional to f^{-1} for frequencies less than 0.1 Hz. The power in the peaks is not dependent upon the height above ground, but the energy deficit in the corresponding dips in the spectra is inversely proportional to height above ground. Unlike the upstream flow, the slopes of the spectra are not dependent upon the height above ground. Fig.9 shows the power spectra of the flow further downstream in the wake. These spectra do not exhibit the pronounced peaks which appear in the spectra of the flow at mast P.

The autocorrelation functions of the horizontal windspeed both upstream and downstream are shown in Fig.10, plotted as a function of time lag. In the near wake, mast P, the correlation drops off much faster than would normally be expected, however there is a second maximum correlation at a lag of about 90 seconds, corresponding to the peak in the spectrum at a frequency of about 10^{-2} Hz. Figs.10e and f show that the second maximum correlation which appeared in the near wake does not show up elsewhere in the downstream flow, except perhaps at 9 m on mast Q where a small second maximum is evident.

4 DISCUSSION

4.1 Velocity and turbulence intensity profiles

Five building heights downstream from the hangar the mean wind is reduced from the upstream value at heights below the building height, due to the sheltering effect of the hangar (Fig.7a). Above the height of the building there is a slight increase in mean wind as a result of the flow accelerating over the top of the hangar. This mean wind profile is very similar to other measured profiles behind obstacles of a similar shape and also agrees with theoretical models of the wake flow up to the building height⁶. At fourteen building heights downstream the velocity deficit is nearly zero at the building height which suggests that the effect of the hangar soon decays. However, at 30 m above ground, 23 building heights downstream the mean windspeed is 9% greater than upstream. This shows that the wake spreads upwards as it moves downstream and therefore the influence of the building will be more noticeable higher up than near the ground.

Since the mean wind and turbulence intensity profiles on mast Z, off the centreline, are the same as the upstream values, it is concluded that mast Z must have been out of the wake behind the hangar.

The turbulence intensity five building heights downstream is very much larger than upstream, the difference being greatest 3 m above ground. However, the mean wind and wind shear in the wake at this height are smaller than the corresponding upstream values which would tend to reduce the turbulence intensity. It is likely that the increase in turbulence intensity is due to oscillations of the whole wake - this will be discussed more fully in section 4.3. Further downstream, at both 14 and 23 building heights downstream, the turbulence intensity is different from the upstream value by a larger factor than the mean velocity profile. This confirms the theoretical prediction⁶ that the turbulence intensity in the wake decays more slowly than the velocity deficit.

4.2 Power spectra and autocorrelation functions

Fig.11 shows how the frequency content of the upstream energy has been altered by the obstruction to the flow. The greatest change takes place 3 m above ground where there is about twice as much energy in the 0.1 Hz - 0.01 Hz band in the wake as in the upstream flow. Since the low frequency energy is about the same in the wake as upstream, it seems that most of the excess energy in the wake has come from the mean flow. At the 9 m level the difference in

energy between upstream flow and wake is less pronounced than at 3 m, except at the high frequency end. The peak is also diminished and the low frequency energy in the wake is less than in the upstream flow. Again, at the 15 m level which is 5 m above the top of the hangar, the difference between upstream flow and wake is not so large although there are still some differences.

Further downstream in the wake this effect of altering the slope of the spectra and producing peaks has disappeared, (see Fig.9). At the 9 m level on mast Q (14 hangar heights downstream) the power spectrum has returned to the shape of the upstream spectrum except for a slight kink at 0.01 Hz. The spectrum of the flow at the top of mast R (23 hangar heights downstream) has completely returned to the shape of the upstream spectrum. The power spectra at mast Z have the same shape as the upstream spectra which confirms the fact, mentioned in the previous section, that mast Z is out of the wake.

In the near wake, mast P, the correlation drops off much faster than upstream, (Fig.10a - c), which suggests that the wake contains smaller eddies than the upstream flow. This effect is greatest near the ground (Fig.10d). However, there is a second maximum correlation at a lag of about 90 seconds which must be due to some larger scale structure of the wake.

4.3 An hypothesis for the wake motion

The peaks in the power spectra of the near wake cannot be explained in terms of discrete vortices shed from the hangar because of the very low frequency, therefore a source of low frequency energy must be found to explain these peaks. It is fortuitous that a part of the time history for 3 m above ground on mast P shows a regular, low frequency (10^{-2} Hz) oscillation of all three turbulence components (see Fig.12). The obvious correlation between the turbulence components and the regular fluctuation in the upstream wind direction immediately suggest a regular oscillation of the whole wake, and this hypothesis is put forward to explain the mechanism which produced low frequency peaks in the power spectra.

The oscillation of the lateral component of upstream velocity is shown in Fig.6. The maximum deviation of the wind vector from the mean direction is given by $\pm \tan^{-1} (a_v/\bar{u})$, where a_v is the semi-amplitude of the lateral oscillation and \bar{u} is the mean longitudinal velocity. This gives a value of $\pm 10^\circ$ for the maximum deviation of the upstream flow from its mean position. This is supported by the fact that the mean upstream wind direction was 9° off the perpendicular to the hangar, and as we have shown that mast Z was not in

the wake, it is reasonable to assume that the wake oscillates by no more than $\pm 10^\circ$ from its mean position. If we assume that the oscillation of the wake has virtually no effect on the wake pattern, since the oscillation is so slow, it is reasonable to think of this as the regular oscillation of the measuring point, mast P, through a fixed wake pattern. In which case, the measurements at mast P give useful information about the wake structure. Further assuming that the wake diverges at an angle of 10° , the two extreme positions of the wake are as shown in Figs.13a and 13c. In these figures a typical wake profile for the longitudinal component of velocity, u , is also shown which has a minimum at the centre of the wake and maxima at the wake edges.

It has been demonstrated in wind tunnel experiments (see, for example, Ref.7) that a trailing horseshoe vortex develops on the wake boundary with some kind of trailing vortex system inside the wake. Although the exact position, strength or size of these vortices cannot be calculated from measurements obtained in this experiment, some idea of the wake structure can be gained from a consideration of the results presented in Fig.12 and Figs.13a and 13c. Near the centre of the wake, Fig.13c, u has a minimum; this corresponds to position B in Fig.12 where v , the lateral component, has a minimum and w , the vertical component, has a small maximum. Thus, we have an upward flow of small magnitude at the wake centre. Near the edge of the wake, Fig.13a, u has a maximum; this corresponds to position A in Fig.12 where v has a maximum and w has a minimum. Thus, we have a flow which is downward and into the wake near the wake boundary. This suggests a circulation in the wake which is depicted in Fig.13b. Thus, we have the hypothesis that the wake structure consists of a trailing horseshoe vortex on the wake boundary, close to the ground, and a trailing vortex inside the wake, centred nearer the top of the building. However, Fig.13b is only schematic and does not necessarily represent the exact positions and sizes of the vortices. Further experiments, both in the full-scale and in a wind tunnel, have been planned to examine the wake structure in more detail.

One further point concerns the reason for the oscillation of the wake flow. In this particular case it can be shown that the oscillation of the wake is almost certainly due to the fluctuation of the lateral component upstream since the upstream and mast P fluctuations of lateral component are out of phase by precisely the time required for the flow to be convected from mast A to mast P, 254 m, at a mean speed of 6.6 m/s. (Positions A and C on Fig.6 are 39 seconds displaced from A and C on Fig.12, defining peaks and

troughs respectively in the low frequency component.) However, it is possible that a wake could oscillate due to some other factor, such as the sudden change of separation point at the edge of the building.

5 IMPLICATIONS OF THE RESULTS

As was mentioned in the Introduction, the main purpose of this experiment was to determine the structure of the wake behind an obstacle on the ground. We now consider the effect of this wake on conventional aircraft, V/STOL aircraft and other structures.

Although power spectral methods were used in this analysis to obtain an insight into the wake flow, these methods are not at all suitable for considering the flight of a conventional aircraft through such a wake. The important factor to the aircraft is not the energy content of different frequency bands in the turbulence, but the spatial gradient of windspeed across the wake because an aircraft on the approach would pass through the wake in about 2 seconds. The oscillation of the wake flow described in the previous section would have no effect on a conventional aircraft because of the long period of the wake oscillation compared with the fast transit time of the aircraft.

On the other hand, a VTOL aircraft descending vertically in the wake region might well be affected by both the slow oscillation of the wake and the energy spectrum of turbulence in the wake, although the spatial gradients of windspeed in the wake are probably more important. Since the VTOL aircraft will probably be landing with nose into the mean wind, the lateral motion of the wake will be experienced as lateral gradients of windspeed by the aircraft. If the aircraft is near the edge of the wake and the wake swings round such that the aircraft enters it, the aircraft will experience a sudden lateral gust followed by increased turbulence intensity. This increase will be greatest in the vertical component, being 4 or 5 times greater than the increase in the lateral and longitudinal components, which might lead to difficulties in handling during the latter stages of the approach.

The power spectrum of the turbulence is the best input to use when calculating the response of buildings and masts to the turbulence in the wake of another building. The increase in energy of the higher frequency components of turbulence in the wake could well have a deleterious effect on the cladding of the building. If the structure, which is probably lightly damped, has a vibrational mode close to the frequency at which the large peak occurs in the

power spectrum of turbulence, the wake may produce quite large loads on the building. The increase of turbulence intensity in the wake will also make it uncomfortable, and perhaps difficult, for pedestrians to move around in the open areas between buildings.

It should be stressed that these implications have been based on only one piece of data from one particular building at one particular site, and therefore no general conclusions can be drawn until further measurements have been made.

6 CONCLUSIONS

A preliminary analysis of measurements of windspeed fluctuations made upstream and in the wake of a hangar have brought to light some interesting features of the wake flow. The mean windspeed in the near wake, five hangar heights downstream, is substantially reduced from the upstream value but this velocity deficit has decayed, at the height of the building, by fourteen hangar heights downstream. A large increase in turbulent intensity was measured in the near wake, and this increase decayed more slowly than the velocity deficit, still being apparent fourteen hangar heights downstream.

In the near wake a large energy peak at a frequency of 10^{-2} Hz occurred at all heights above ground up to 15 m, the highest measuring level. Because of the low frequency and the lack of a peak further downstream, it is not likely to have been due to regular vortex shedding. An hypothesis is put forward to explain this peak as the regular oscillation of the whole wake which is supposed bounded by two horseshoe vortices with axes along the wake boundary. This hypothesis is consistent with a part of the measured velocity time history which shows a well correlated regular fluctuation. A conventional aircraft will experience the wake as a discrete gust, whereas V/STOL aircraft may find the movement of the spatial gradients in the wake flow to be important.

Further measurements of all three turbulence components will have to be made in the hangar wake in order to substantiate this hypothesis and to examine how critical the upstream mean wind direction is in determining the wake characteristics. In addition to further velocity measurements, it is proposed that some flow visualization be performed in order to obtain a clearer idea of the mechanism involved.

Table 1

Anemometer position	Mean windspeed m/s	rms m/s	$\frac{\text{Mean}}{U_0}$	$\frac{\text{rms}}{U_0}$	$\frac{\text{rms}}{\text{mean}}$
A 30	9.91	1.46	0.583	0.086	0.147
A 18	9.34	1.69	0.550	0.099	0.181
A 09	8.06	1.48	0.474	0.087	0.184
A 03	6.65	1.26	0.391	0.074	0.189
Z 15	8.96	1.55	0.527	0.091	0.173
Z 09	8.36	1.51	0.491	0.089	0.181
P 15	9.16	1.78	0.538	0.105	0.194
P 09	6.90	1.68	0.406	0.099	0.243
P 03	5.87	1.60	0.345	0.094	0.273
Q 09	7.80	1.53	0.459	0.090	0.196
R 30	10.75	1.74	0.633	0.102	0.162

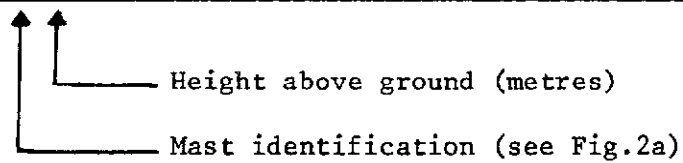

U_0 is the extrapolated value of mean windspeed at the top of the boundary layer (600 m). $U_0 = 17$ m/s.

REFERENCES

<u>No.</u>	<u>Author(s)</u>	<u>Title, etc.</u>
1	J. Burnham	A note on turbulence problems associated with take-off and landing. RAE Technical Report 67240 (ARC 29520) (1967)
2	M.J. Colmer	Dynamic response tests on windvanes and anemometers in a wind tunnel. (to be published)
3	J.S. Bendat A.G. Piersol	Measurements and analysis of random data. John Wiley & Sons Inc., New York (1966)
4	A.G. Davenport	The relationship of wind structure to wind loading. Proc. of symp. on wind effects on buildings and structures at NPL, June 1963. HMSO (1965)
5	J. Burnham M.J. Colmer	An analysis of measurements of horizontal windspeed and gustiness made at several levels on a 30 m tower. (to be published)
6	J.C.R. Hunt G.P. Smith	A theory of wakes behind buildings and some provisional experimental results. CERL Laboratory Note RD/L/N 31/69 (1969)
7	N. Gregory W.S. Walker	The effect on transition of isolated surface excrescences in the boundary layer. R & M No.2779, ARC 13436 (1956)

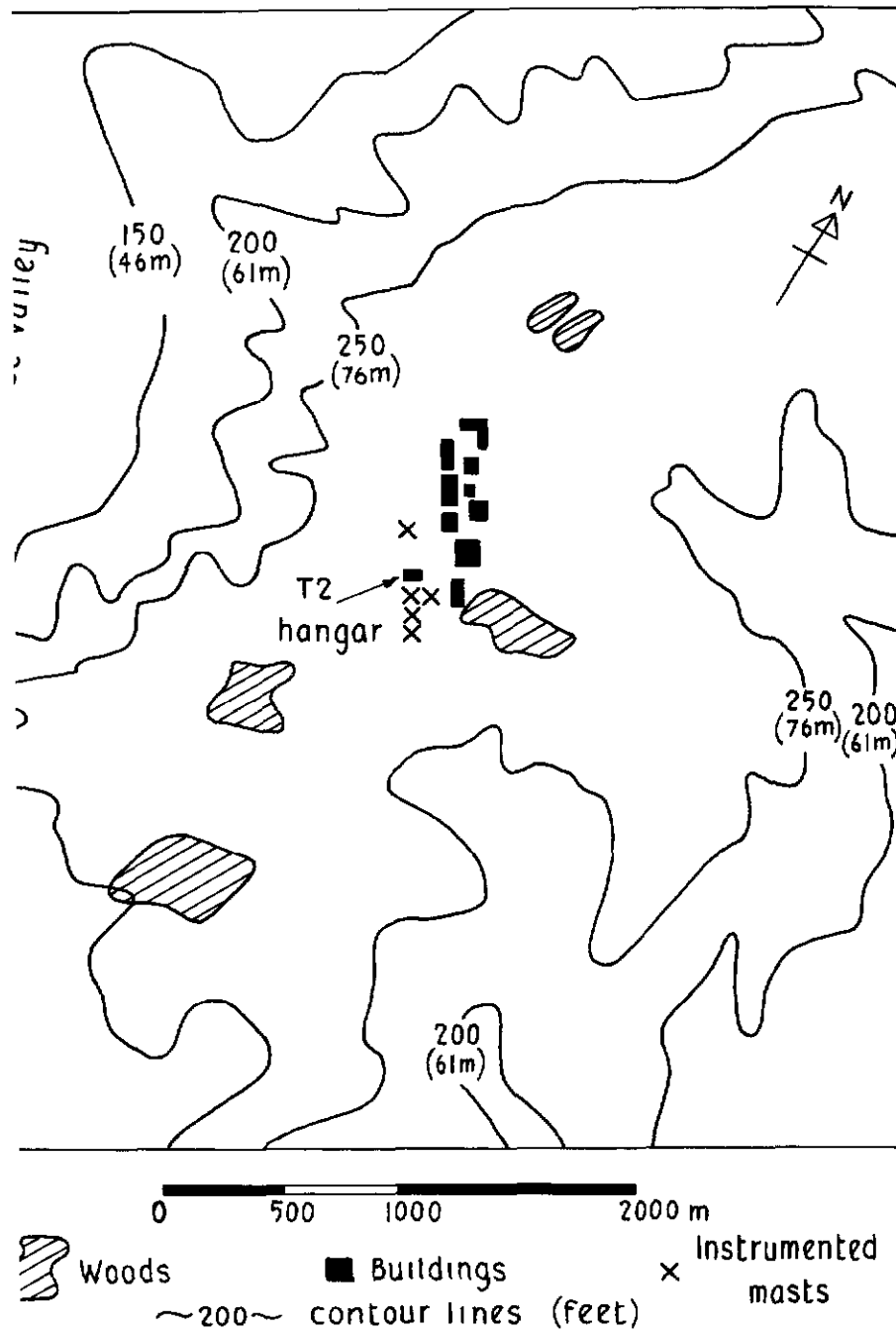
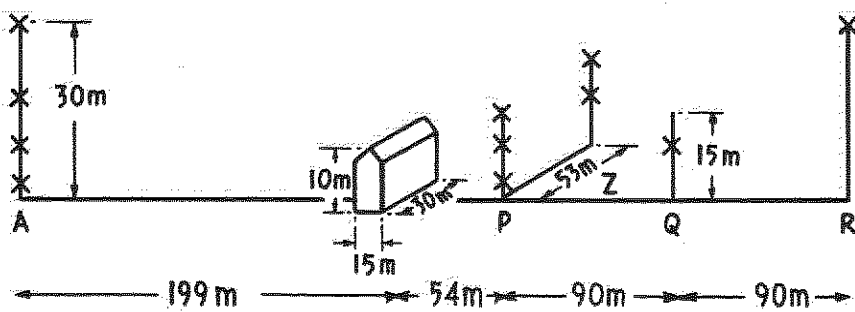
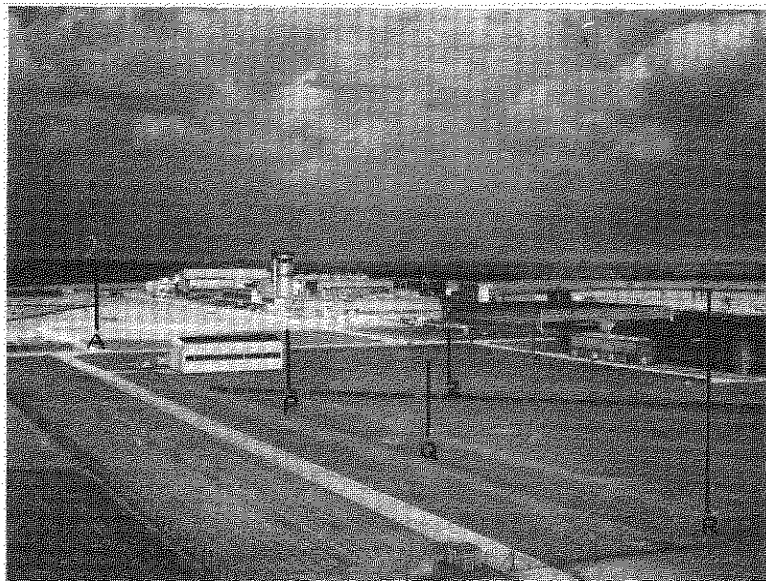

Fig 1 Map of site and its environment

x Indicates the position of the instruments



a Layout of experimental site



b General view of experimental site

Fig.2a & b The experimental site

08 14 3 42 52 1.2 1.6 1.8

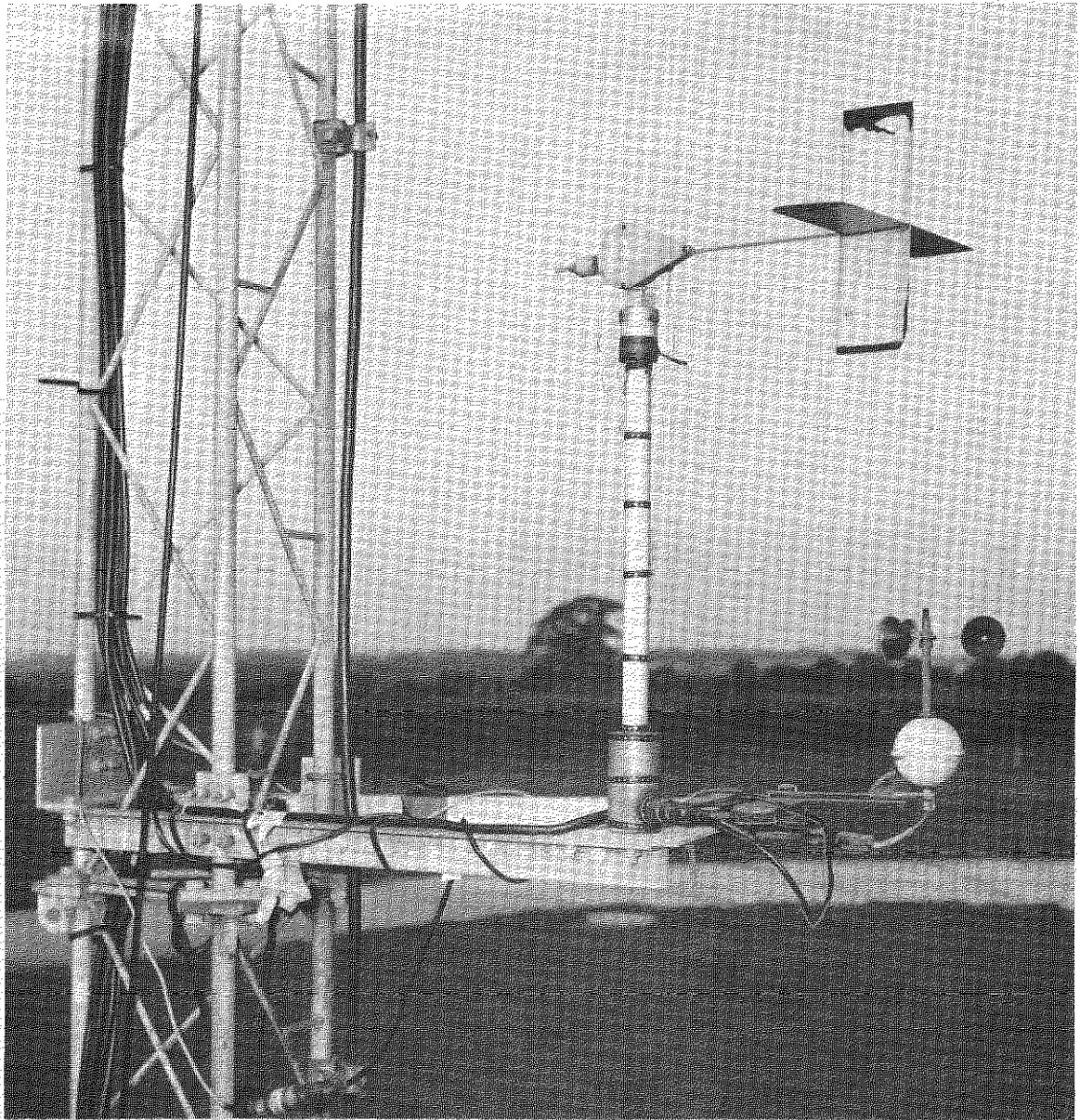

Fig.3. An anemometer and a bi-vane on an instrument platform

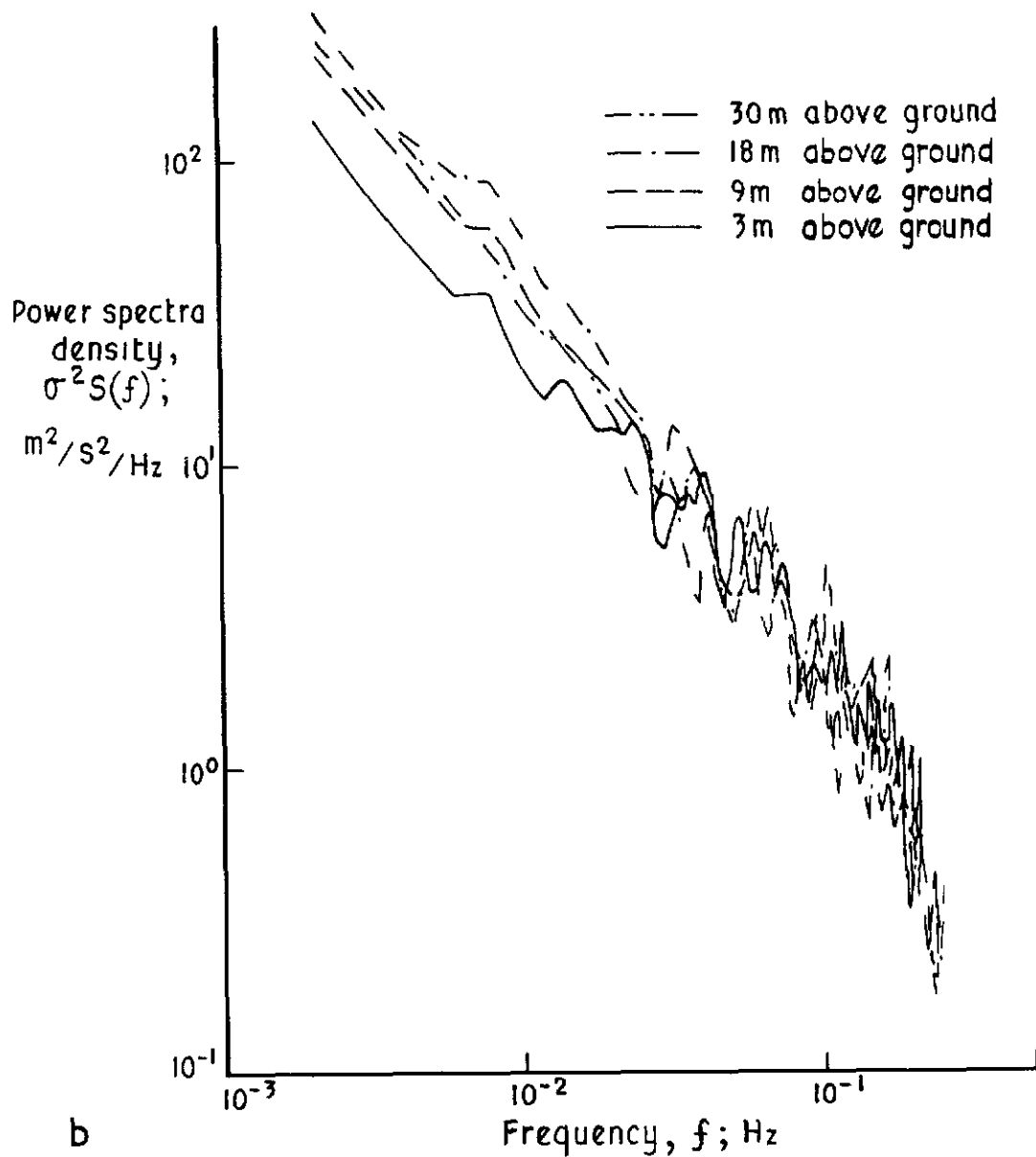
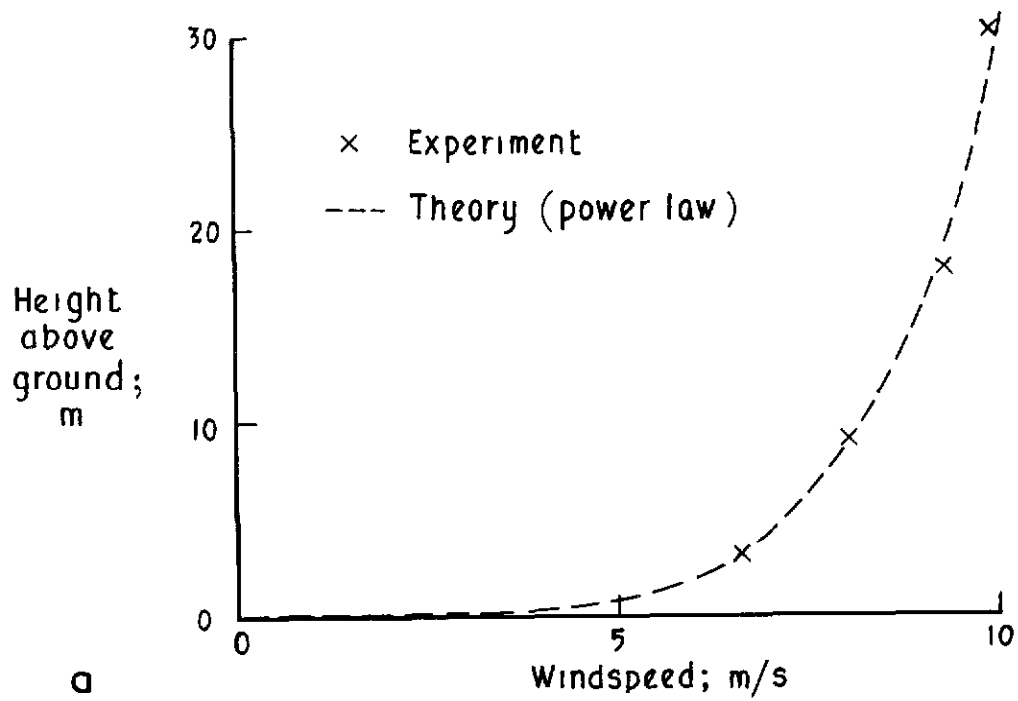

Fig 5a&b Upstream (mast A) mean wind profile and power spectra

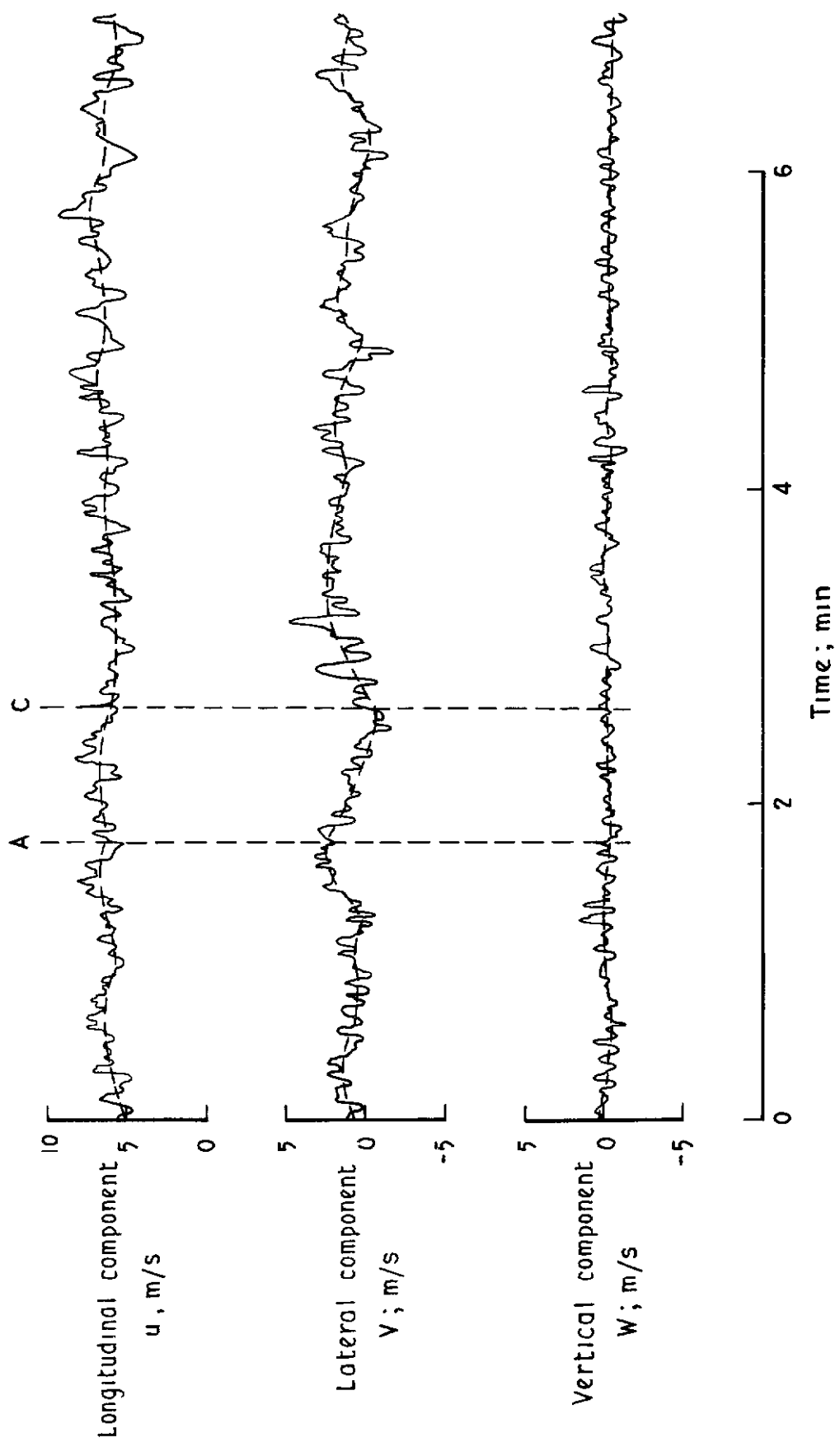
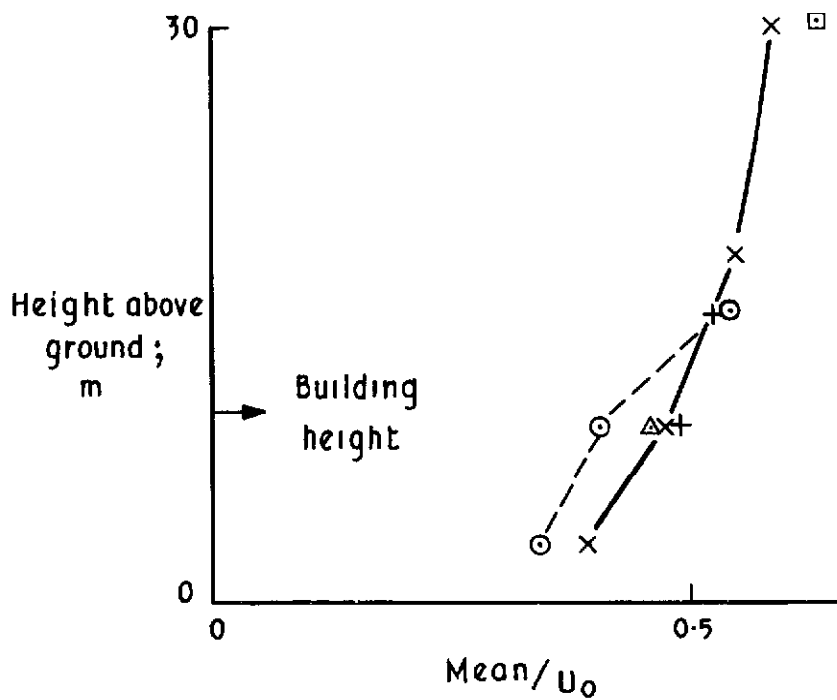
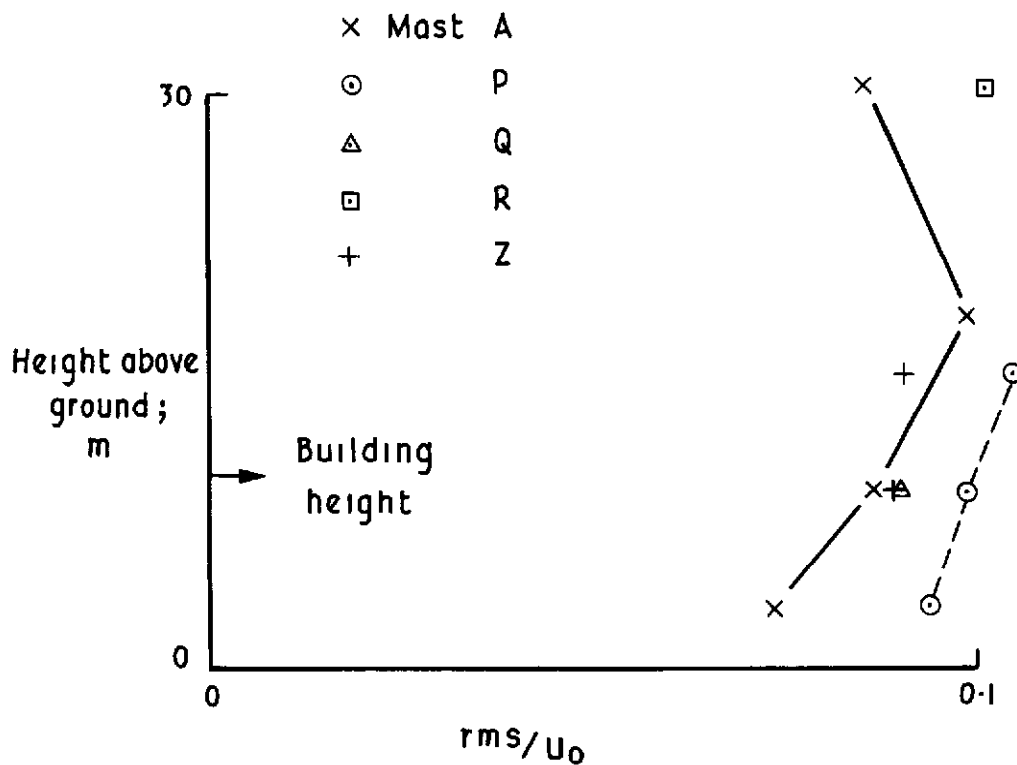

Fig.6 Part of the time history of the three components of upstream velocity; 3m above ground on mast A



a The variation of mean windspeed with height

U_0 is the value of mean windspeed at the top of the boundary layer (600 m) $U_0 = 17$ m/s



b The variation of rms with height

Fig 7a & b Mean windspeed and rms height profiles

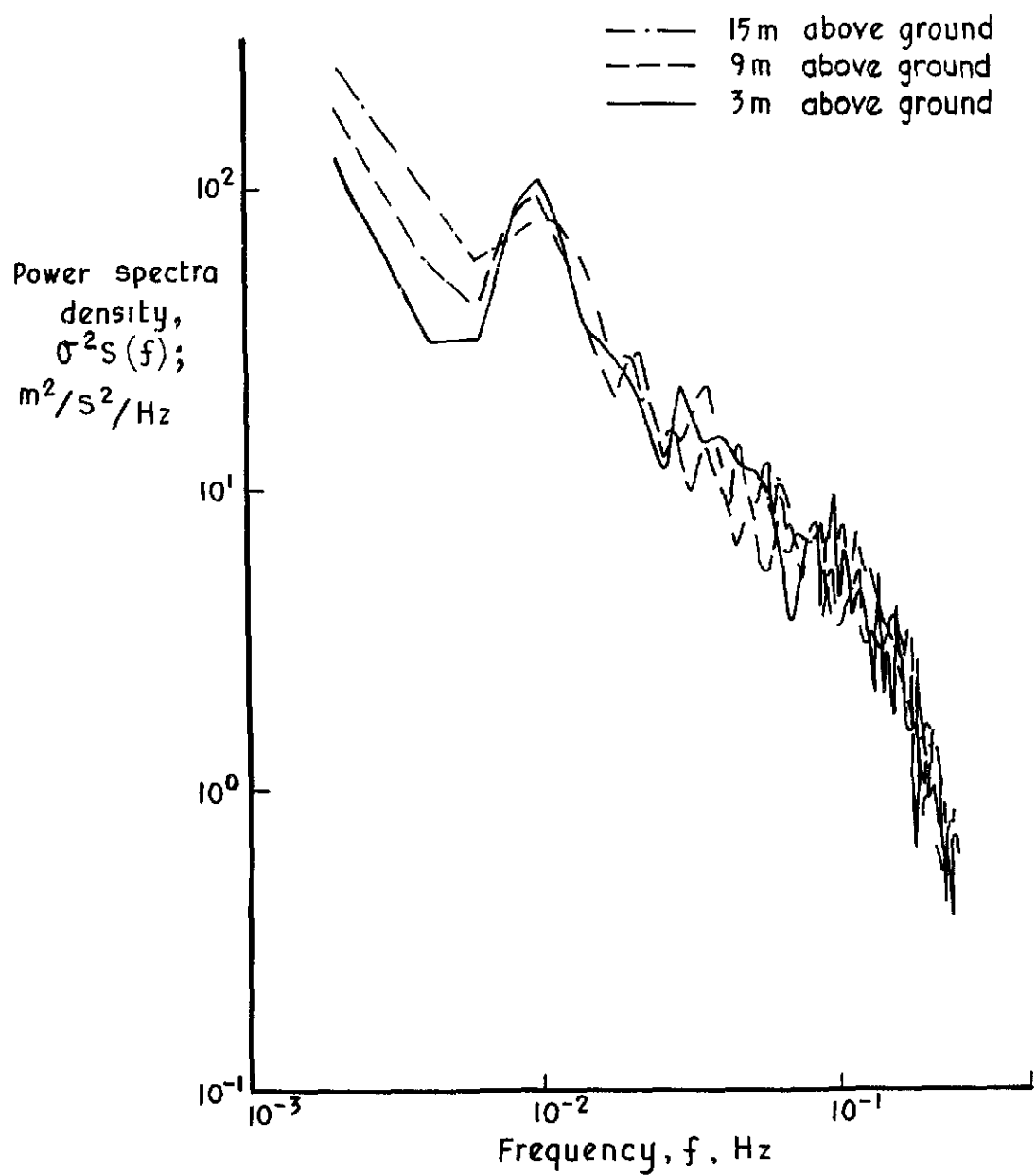
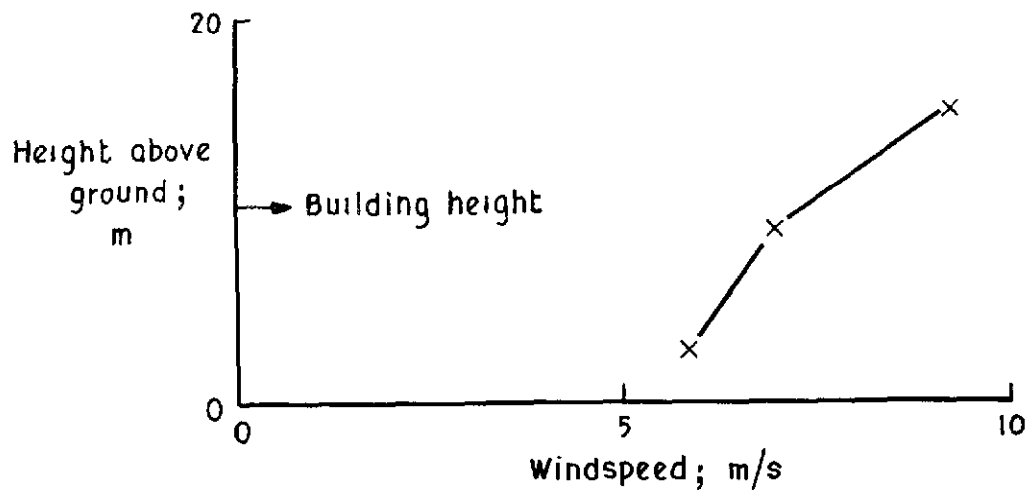

Fig 8 Mean wind profile and power spectra
5 building heights downstream

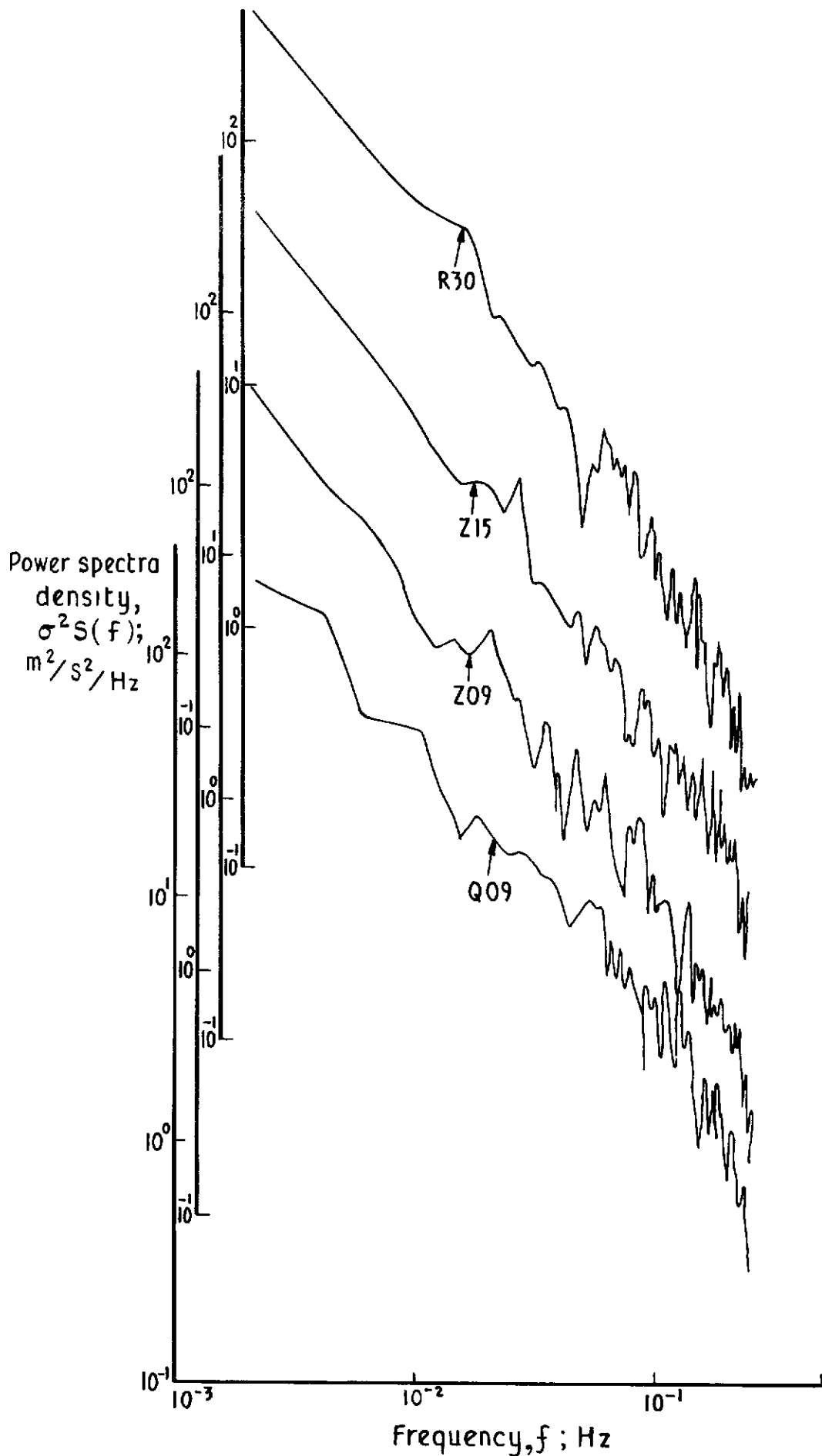

Fig 9 Downstream spectra (masts Q,R,Z)

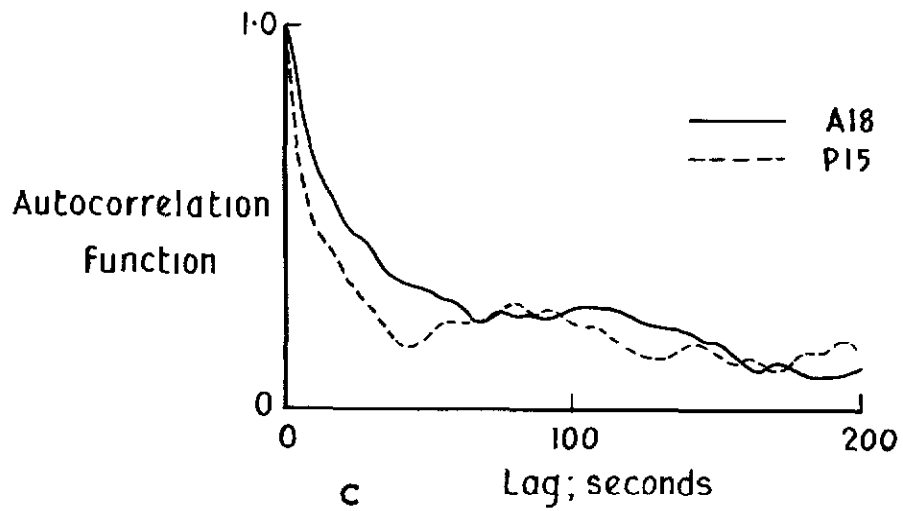
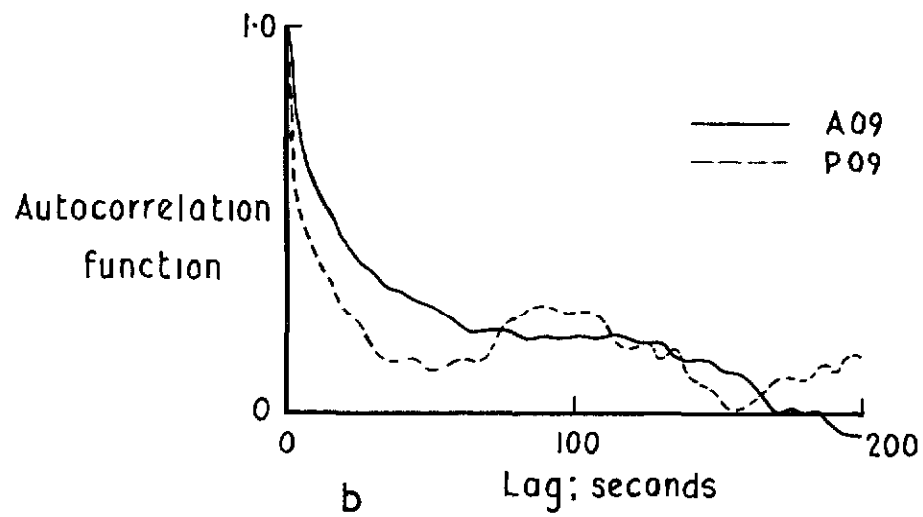
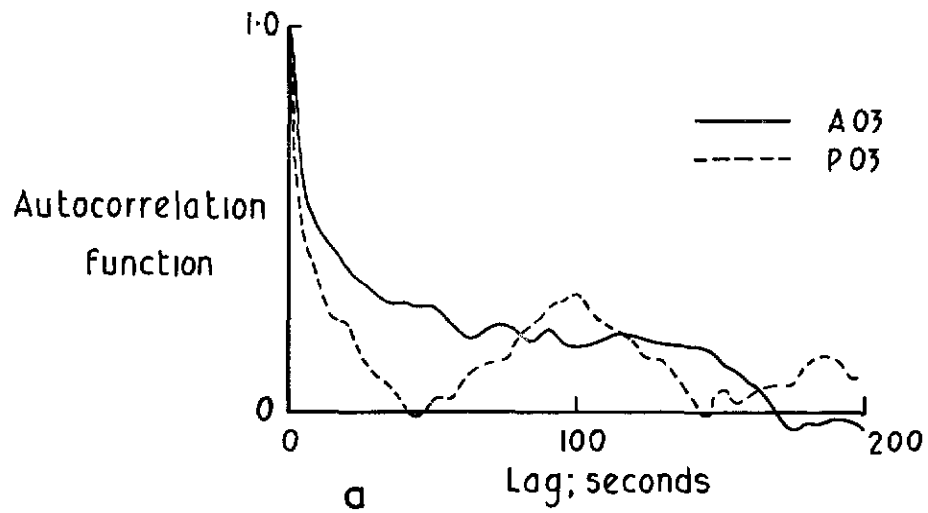

Fig.10 Comparison of autocorrelation functions upstream and in the wake

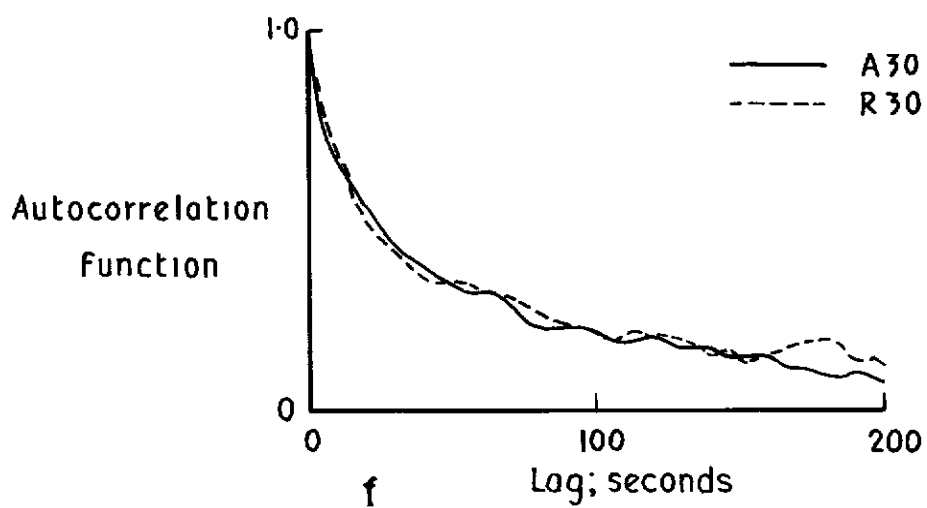
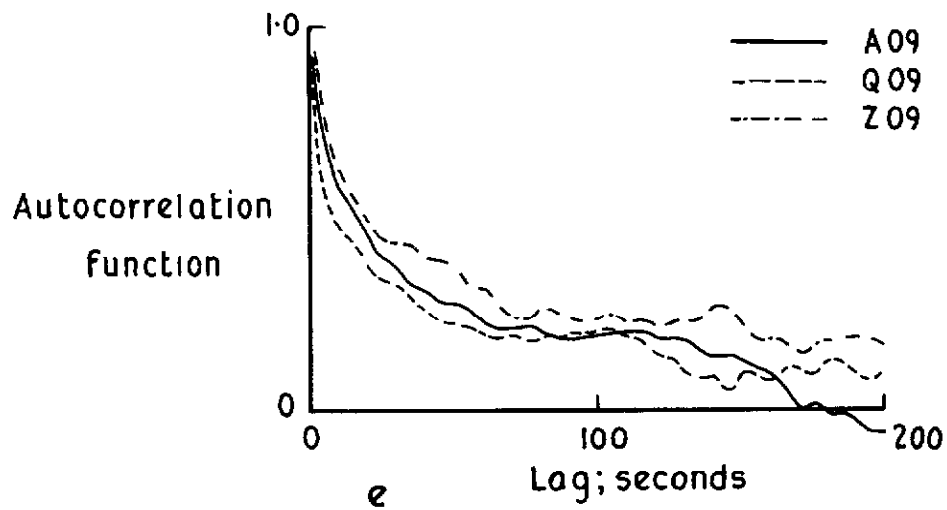
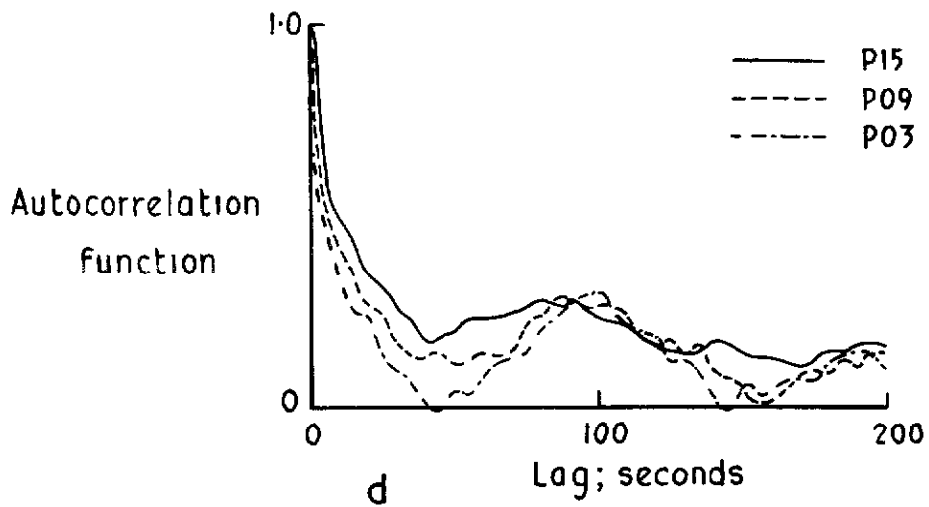

Fig.10 contd Comparison of autocorrelation functions upstream and in the wake

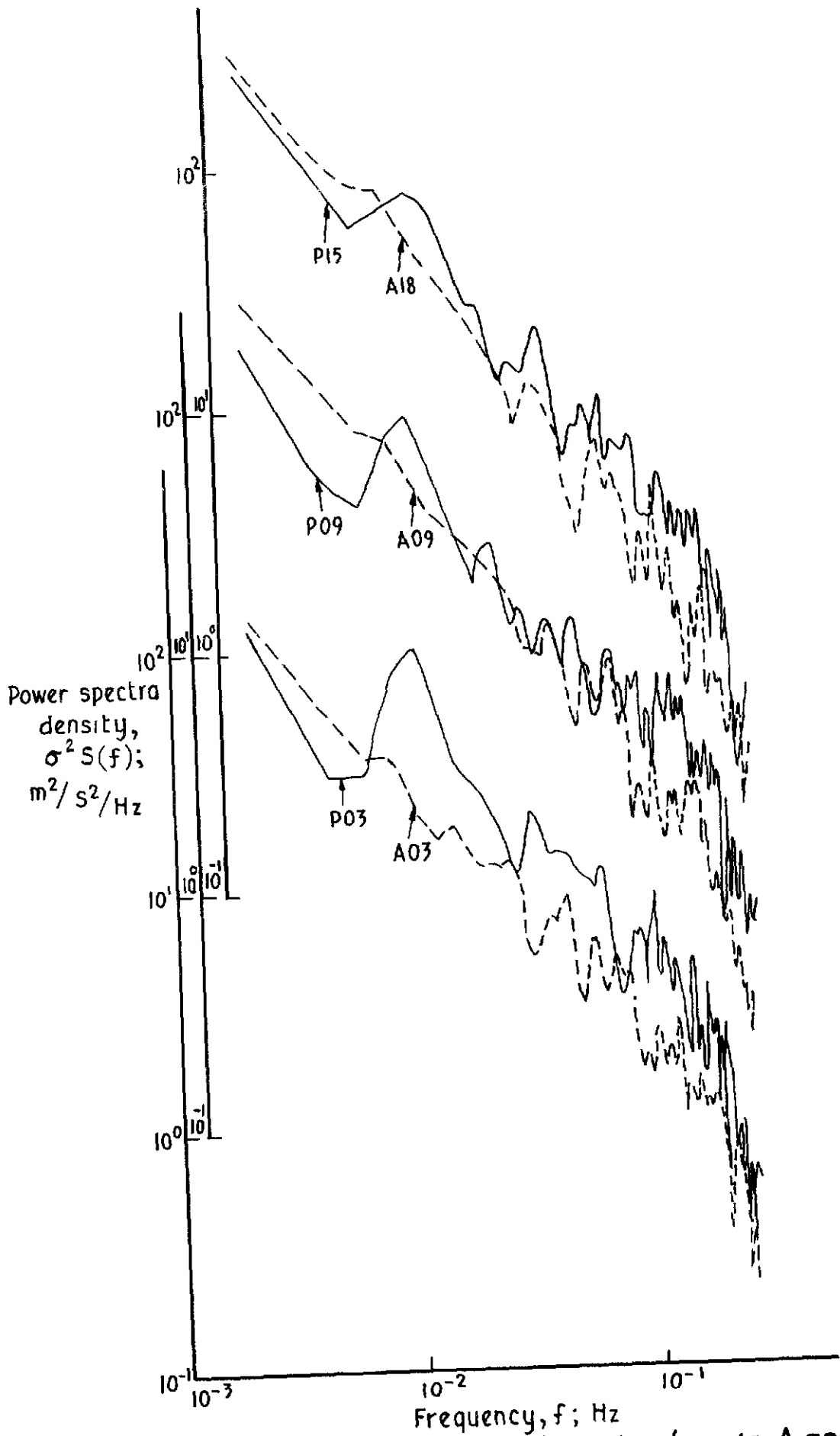

Fig II Comparison of upstream and wake (masts A and P) power spectra

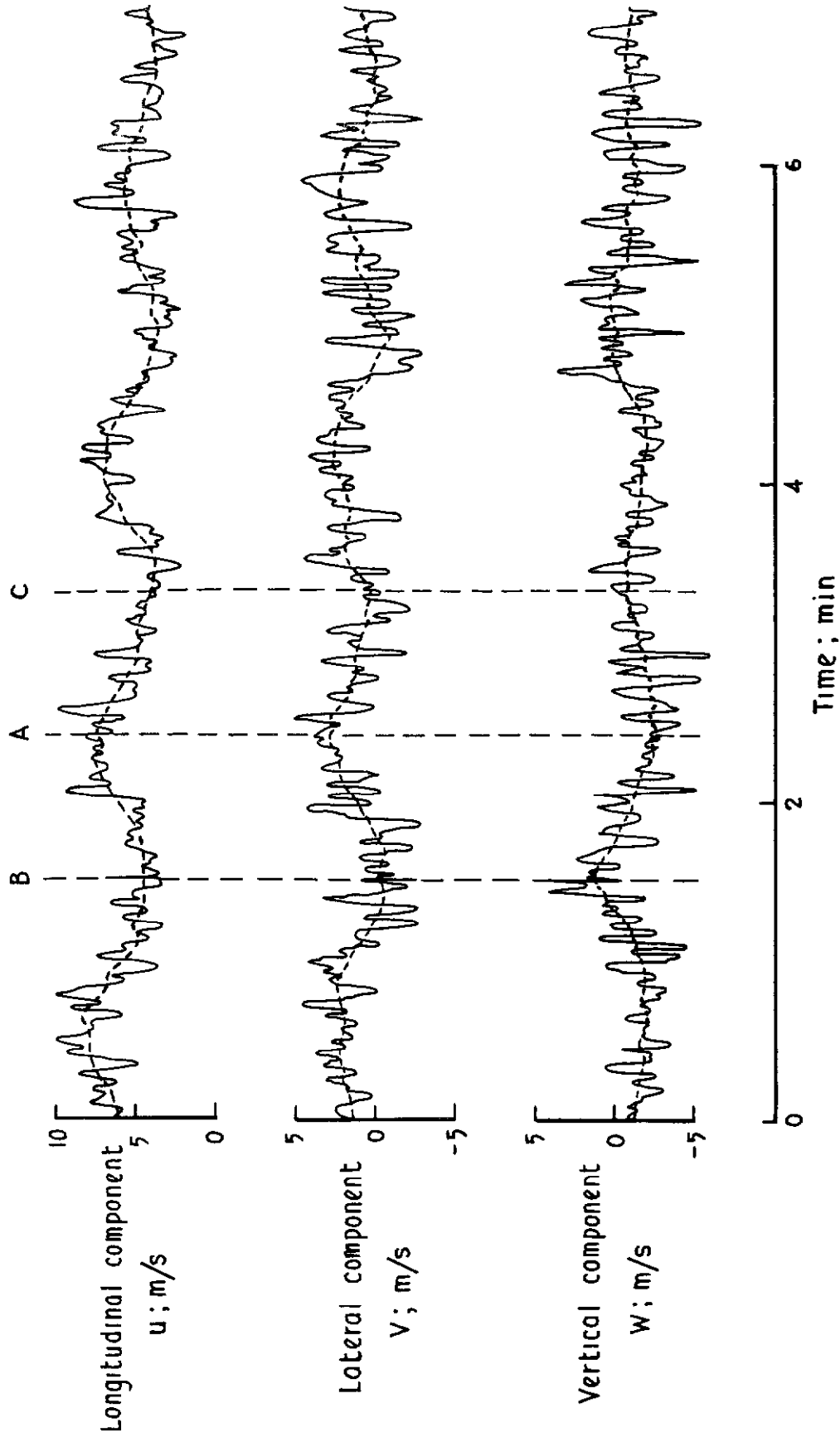

Fig.12 Part of the time history of the three components of velocity
3m above ground on mast P

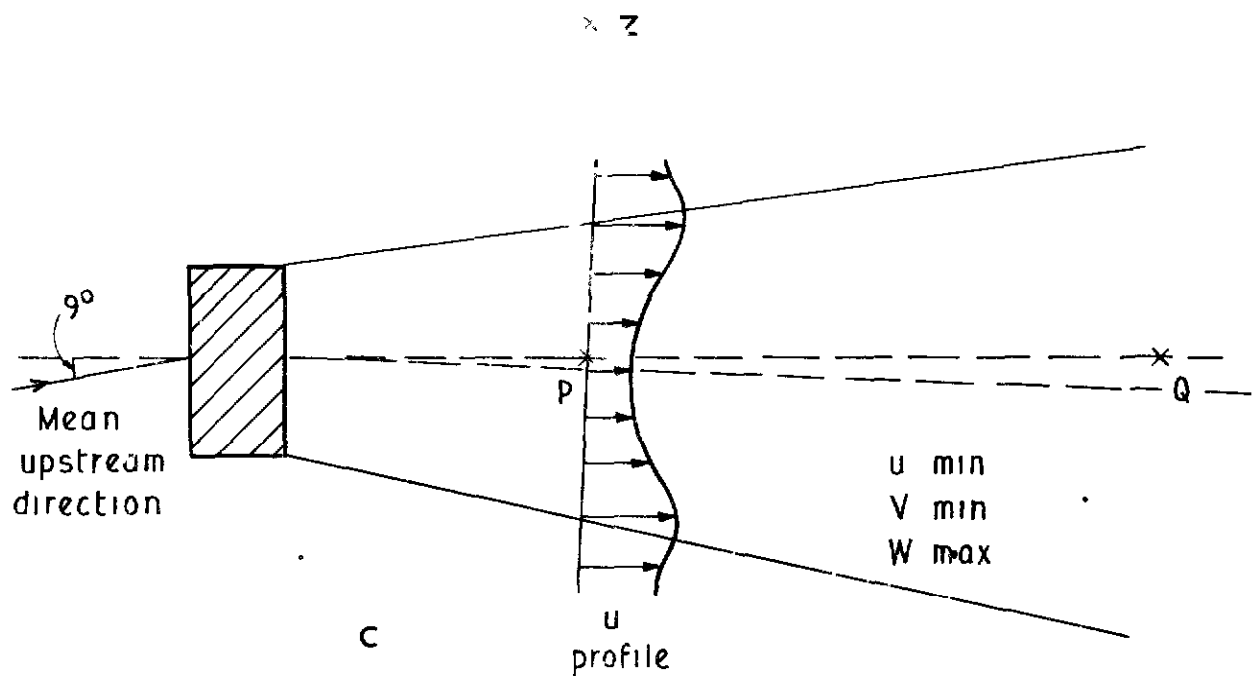
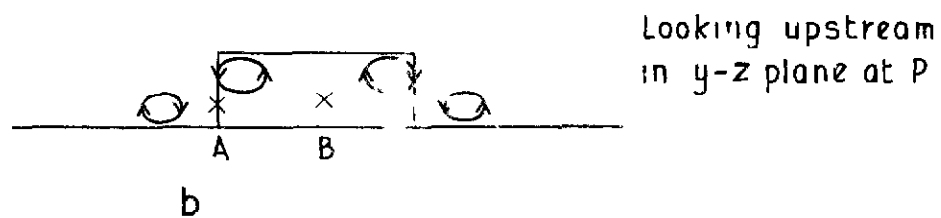
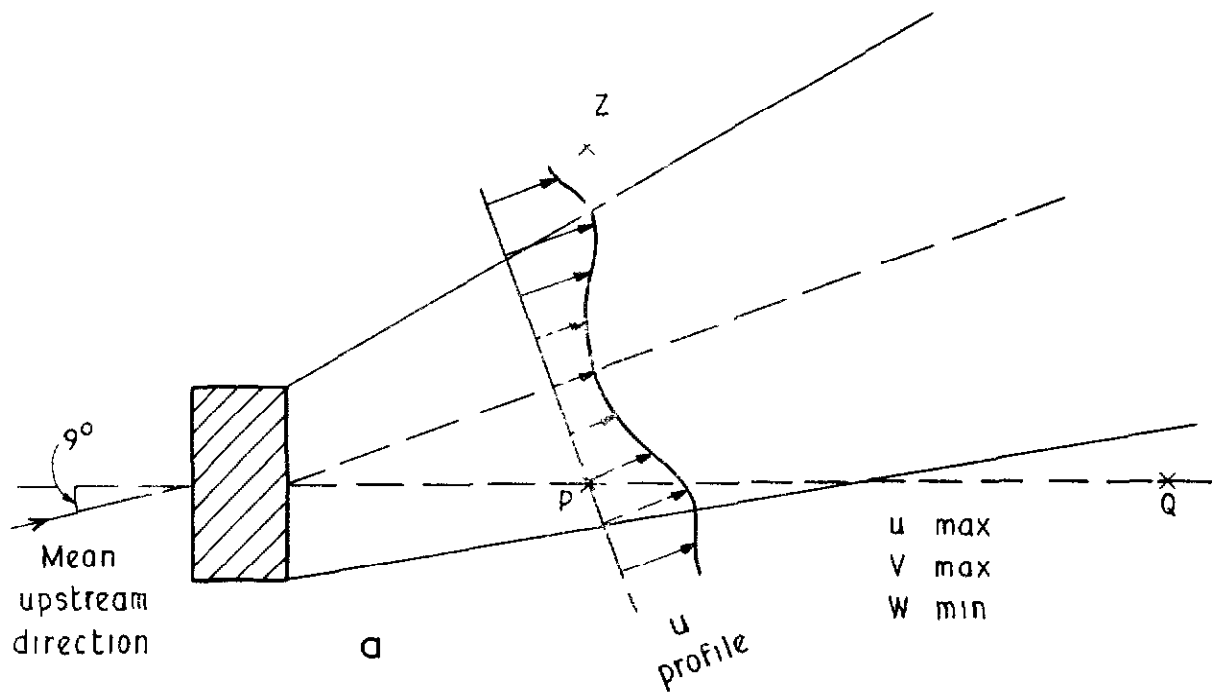

Fig 13 a-c Extreme positions of the wake, (a) and (c), and vertical cross section at mast P, (b), based on model wake

DETACHABLE ABSTRACT CARD

A.R.C. C.P. No.1166
November 1970

Colmer, M J

**SOME FULL-SCALE MEASUREMENTS OF THE
FLOW IN THE WAKE OF A HANGAR**

An experiment to measure the flow behind a full-scale building at RAE Bedford is described. The results of one set of data show that the whole wake was slowly oscillating and that the turbulence intensity in the wake was greater than upstream. An hypothesis for the wake motion is put forward and the effect of the wake behind a building on conventional and V/STOL aircraft is considered.

624 03 .
533.6
629 139.2 :
533 6 048.3 .
532.517.4

A.R.C. C.P. No.1166
November 1970

Colmer, M J

**SOME FULL-SCALE MEASUREMENTS OF THE
FLOW IN THE WAKE OF A HANGAR**

An experiment to measure the flow behind a full-scale building at RAE Bedford is described. The results of one set of data show that the whole wake was slowly oscillating and that the turbulence intensity in the wake was greater than upstream. An hypothesis for the wake motion is put forward and the effect of the wake behind a building on conventional and V/STOL aircraft is considered.

624 03
533 6
629 139.2 .
533 6 048.3 .
532.517.4

C.P. No. 1166

© *Crown copyright 1971*

Published by
HER MAJESTY'S STATIONERY OFFICE

To be purchased from
49 High Holborn, London WC1 V 6HB
13a Castle Street, Edinburgh EH2 3AR
109 St Mary Street, Cardiff CF1 1JW
Brazenose Street, Manchester M60 8AS
50 Fairfax Street, Bristol BS1 3DE
258 Broad Street, Birmingham B1 2HE
80 Chichester Street, Belfast BT1 4JY
or through booksellers

C.P. No. 1166

SBN 11 470434 1